



• HAKKIMIZDA / ABOUT US	1
• KONİK SIKMALI BURÇLAR / TAPER LOCK BUSHES	2
○ Burçlu Sistem Montaj ve Demontaj.....	3
(Systems with the taper bush - Montaj and Demontaj)	
○ Burç kodları, Delik Çapları ve Kama Kanalı Boyutları.....	4
(Systems with the taper bush, Bore Diameters)	
○ Burç Kodlarının Anlamı.....	5
(Bush Code and Meaning)	
• BURÇLU-V KAYIŞ KASNAKLARI / V PULLEY WITH TAPER BUSH	6
○ DIN 2211 Standartlarında V Kasnak Kanalı Ölçüleri.....	7
(V Pulley Grooves Dimension at DIN 2211 Standarts)	
○ Motor Gücü ve devir sayısına Göre V Kasnak Seçimi.....	8
(Choosing of The V Pulley According to The Motor Power and Rpm)	
○ Siparişte Kullanılan Kodlama Yöntemi.....	9
(Nomenclature for The Order)	
○ SPZ.....	10
○ SPA.....	17
○ SPB.....	23
○ SPC.....	31
• BURÇLU POLY-V KAYIŞ KASNAKLARI / POLY-V PULLEYS WITH TAPER BUSH	37
○ Motor Gücü ve Devir Sayısına Göre Poly-V Kasnak Seçimi.....	38
(Choosing of The Poly-V Pulleys According to The Motor Power and Rpm)	
○ Poly-V Kasnak Kanalı Profil Ölçüleri.....	38
(Profile Dimensions of The Poly-V Grooves)	
○ Siparişte Kullanılan Kodlama Yöntemi.....	38
(Nomenclature for The Order)	
○ Pj Profilli Burçlu Poly-V Kasnakları.....	39
(Pj Poly-V Pulleys)	
• KAPLİNLER / COUPLINGS	46
○ Yıldız Kaplin ve Siparişte Kullanılan Kodlama Yöntemi.....	47
(The codification method that is used in orders)	
○ Elastik Dişli Kaplin.....	48
○ Ayaklı Kaplin.....	49
• KÖR KASNAKLAR VE ÖZEL ÜRETİMLER / V PULLEYS AND SPECIAL PRODUCTIONS	50
○ Mevcut Modeller.....	51
(Available Models)	
○ Özel Üretimler.....	52
(Spacial Productions)	
• ABOUT US	53





Burçlu Sistem / Systems with the taper bush

Kullanıldığı Yerler;

- 1) V Kayış Kasnakları
- 2) Poly V Kayış Kasnakları
- 3) Kaplinler
- 4) Varyatörler
- 5) Zincir dişlileri
- 6) Triger Dişliler
- 7) Flanşlar
- 8) Kamalı mile bağlanması gereken bütün elemanlar

They are used for;

- 1) The V belt pulleys
- 2) The poly-V belt pulleys
- 3) The couplings
- 4) The variable speed pulley
- 5) The sprockets
- 6) The timing belt pulleys
- 7) The flanges
- 8) All the components to be assembled to the pin with keyway

Özelliği; / Sepecifications;

Elemanların göbeğinde burca uygun konik yuva olmaktadır. Burç bu yuvaya oturtularak, mile kaygan olarak elle takılır, setstür vidalar sıkma deliklerine takılır ve sıkılırsa pres de geçme sıklığında mote edilmiş olur. Setstürleri söküp birini demontaj deliğine takıp sıkığımızda ise malle eleman ayrılmış olur.

(The conical bore suitable to the taper bush is located in the center of the components. The taper bush is assembled to this bore. It is manually assembled by sliding to the pin. The set screws are assembled in the frequency of press fit. If the set screws are disassembled and one of them is assembled to the disassembly bore and it is pressed then the pin and the element will be separated each other.)

Avantajları; / The Advantages;

- 1) Kamalı mile elle kaygan olarak monte edildiği için montaj çok kolay ve çabuk olur.
- 2) Setstür vidaları sıkıldığında elemanı mile sabitlendiği için mili aşandırmaz ve kamaya yük gelmediği için kamayı kesmez.
- 3) Montajda çekiç kullanılmadığı için eleman yıpranmaz.
- 4) Söküm için setstürleri çıkarıp demontaj yerine takıp sıkığımızda eleman milden ayrılır. Boşa çıkan elemanı elle çıkarıp alabildiğimiz için demontaj çok kolaydır.

- 1) The assemblage is done easily and quickly because it is manually assembled by sliding to the keyway
- 2) It doesn't corrode the mil because the set screws are pressed and fixed the element to the pin and it doesn't cut the keyway because the load isn't on the keyway.
- 3) The element isn't frayed because the hammer isn't used in the assemblage.
- 4) If the set screws are disassembled and they are assembled and pressed to the disassembly place, the element will be very easy because the disassembled element is taken by hand.

Montaj ve Demontaj / Montaj and Demontaj

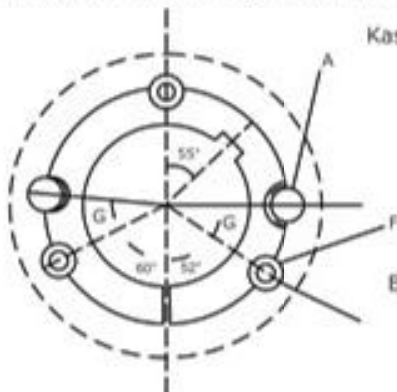

Kasnaktan sökmek için yuvanın yarısına dış açılmış, göbeğin yarısına dış açılmamıştır.

Burcu kasnağa sıkmak için göbeğin yarısına dış açılmış, yuvanın yarısına dış açılmamıştır.

Konik Sıkmalı Burçlar

Taper Lock Bushes



Burçlu Sistem / Systems with the taper bush

Delik Çapı (Bore Diameters)	KAMA KALINLIĞI (Dagger Thick)		KONİK BURÇ TİPİ (Taper Bush Type)													
	Genişlik (width)	Derinlik (depth)	1008	1108	1210	1610	1615	2012	2517	3020	3030	3525	3535	4040	4545	5050
9	3	1,4	x	x												
10	3	1,4	x	x												
11	4	1,4	x	x	X											
12	4	1,8	x	x	x											
14	5	2,3	x	x	x	x	x	x								
15	5	2,3	x	x	x	x	x	x								
16	5	2,3	x	x	x	x	x	x	X							
18	6	2,8	x	x	x	x	x	x	x							
19	6	2,8	x	x	x	x	x	x	x							
20	6	2,8	x	x	x	x	x	x	x							
22	6	2,8	x	x	x	x	x	x	x							
24	8	3,3	x	x	x	x	x	x	x							
25	8	3,3	x	x	x	x	x	x	x	x						
28	8	3,3			x	x	x	x	x	x						
30	8	3,3			x	x	x	x	x	x						
32	10	3,3			x	x	x	x	x	x						
35	10	3,3				x	x	x	x	x	x	x	x			
38	10	3,3				x	x	x	x	x	x	x	x			
40	12	3,3				x	x	x	x	x	x	x	x	X		
42	12	3,3				x	x	x	x	x	x	x	x	x		
45	14	3,8							x	x	x	x	x	x		
48	14	3,8							x	x	x	x	x	x		
50	14	3,8							x	x	x	x	x	x		
55	16	4,3							x	x	x	x	x	x	x	
60	18	4,4							X	x	x	x	x	x	x	
65	18	4,4								x	x	x	x	x	x	
70	20	4,9								x	x	x	x	x	x	
75	20	4,9								x	x	x	x	x	x	x
80	22	5,4										X	X	x	x	x
85	22	5,4											X	x	x	x
90	25	5,4											X	x	x	x
95	25	5,4												x	x	x
100	28	6,4												X	X	x
105	28	6,4													x	x
110	28	6,4													X	x
115	32	7,4														x
120	32	7,4														X
125	32	7,4														x

Konik Sıkmalı Burçlar

Taper Lock Bushes



Burç Kodları ve Anlamları / Bush Code and Meaning

KOD (Code)	MAKSİMUM DELİK ÇAPI (Max. Bore Diameters)	BURÇ YÜKSEKLİĞİ INCH - MM (Bush Height)
1008	1.0" - 25	0.8 - 20.3
1108	1.1" - 28	0.8 - 20.3
1210	1.2" - 32	1.0 - 25.4
1610	1.6" - 42	1.0 - 25.4
2012	2.0" - 50	1.2 - 30.4
2517	2.5" - 60	1.7 - 43
3020	3.0" - 75	2.3 - 50
3030	3.0" - 75	3.0 - 75
3525	3.5" - 100	2.5 - 63.5
3535	3.5" - 100	3.5 - 88.9
4040	4.0" - 100	4.0 - 100
5050	5.0" - 125	5.0 - 125

KOD FORMÜLÜ

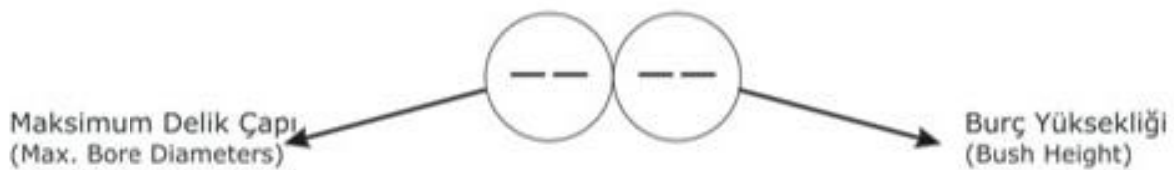

BURÇLU KASNAKLAR
PULLEY WITH TAPER BUSH





DIN 2211 Standartlarında V Kasnak Kanalı Ölçüleri
(V Pulley Grooves Dimension at DIN 2211 Standarts)

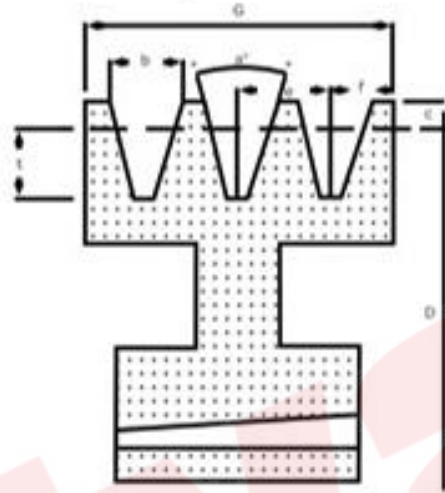

SEMBOL	Z	A	B	C
ÖLÇÜ	10	13	17	22
b	9.7	12.7	16.3	22
c	2	2.8	3.5	4.8
e	12	15	19	25.5
f	7	9	11.5	16
t	11	14.3	17.7	24.7
$a^\circ = 32^\circ$				
$a^\circ = 34^\circ$	$D \leq 80$	$D \leq 118$	$D \leq 190$	$D \leq 315$
$a^\circ = 36^\circ$				
$a^\circ = 38^\circ$	$D > 80$	$D > 118$	$D > 190$	$D > 315$

KANAL SAYISI	Z	A	B	C
1	16	20	25	34
2	28	35	44	59.5
3	40	50	63	85
4	52	65	82	110.5
5	64	80	101	136
6	76	95	120	161.5
8	-	-	158	212.5
10	-	-	196	263.5
12	-	-	234	314.5

Burçlu V Kayış Kasnakları

V Pulley With Taper Bush



Motor Gücü ve devir Sayısına Göre V Kasnak Seçimi
(Choosing of The V Pulley According to The Motor Power and Rpm)

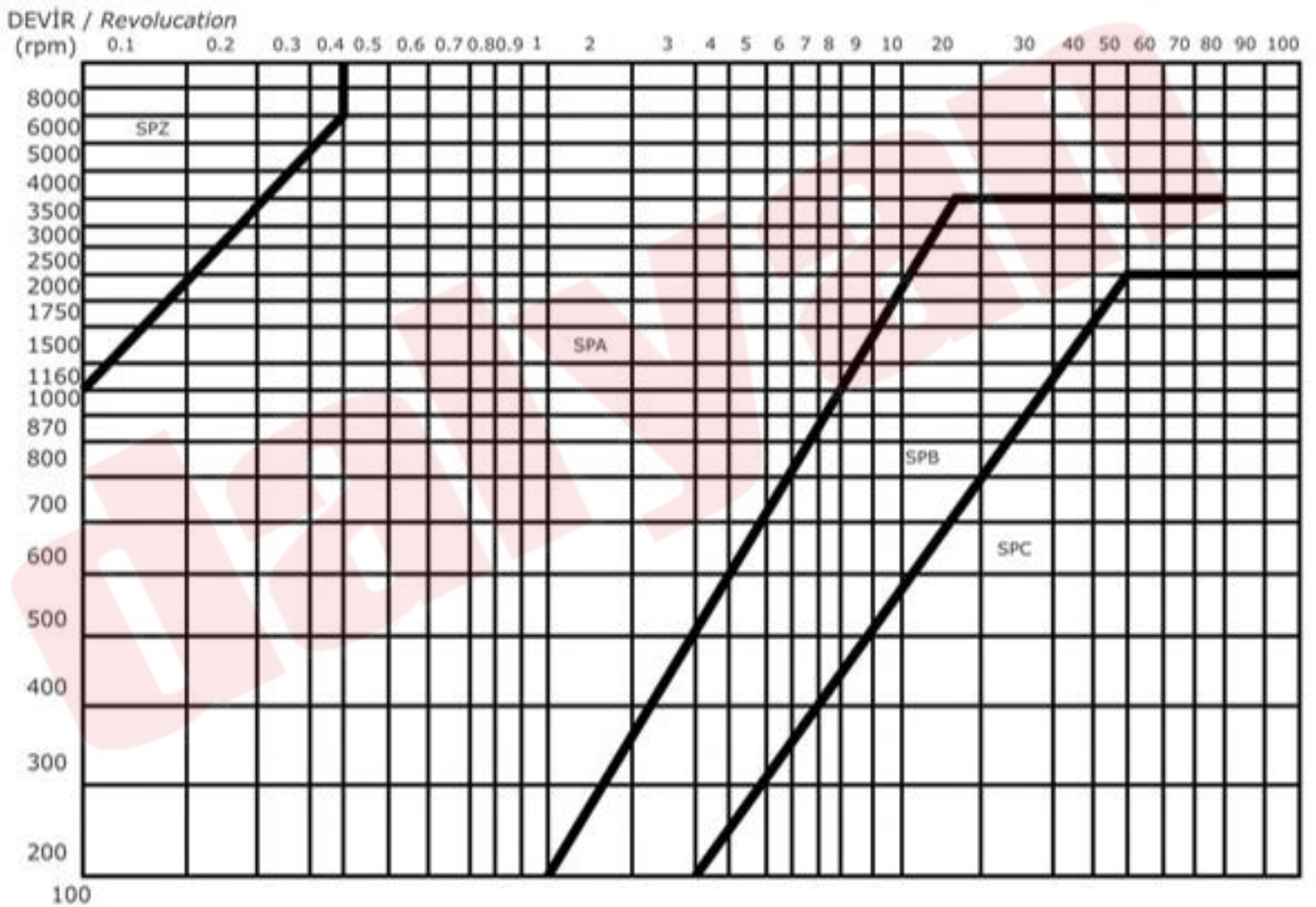



Siparişte Kullanılan Kodlama Yöntemi (Nomenclature for The Order)

● KODLAMADA KULLANILAN DEĞİŞKENLER / USE VARIABLES FOR CODE

- Anma Çapı / Diameter
- Kanal Sayısı / Groove
- Kayış Tipi / Belt Type
- Mil Çapı / Mile Diameter

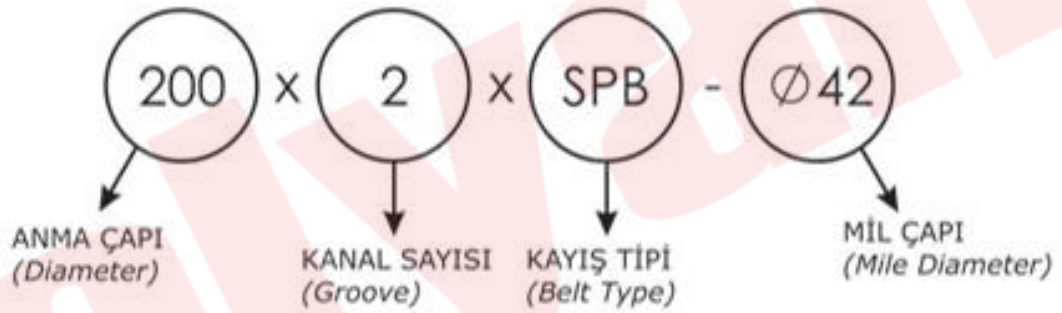

Burçlu V Kayış Kasnakları

V Pulley With Taper Bush



SPZ / 1

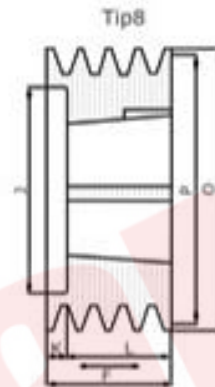
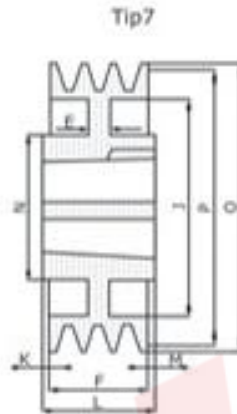
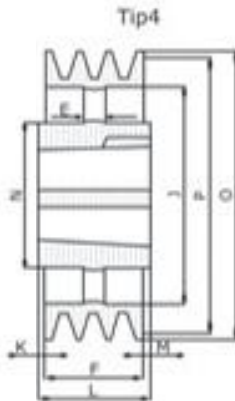
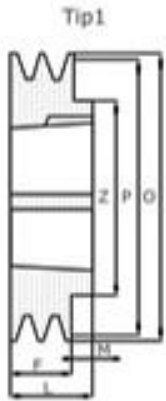

Kod (Code)	Kanal (Grooves)	P	O	Tip (Type)	Burç (Bush)	Maks. Delik (Max. Bore)	E	F	J	K	L	M	N
SPZ 50-01	1	50	54	9	1008	25	-	37	28	15	22	-	-
SPZ 56-01	1	56	60	9	1008	25	-	37	23	15	22	-	-
SPZ 60-01	1	60	64	9	1008	25	-	22	-	-	22	-	-
SPZ 63-01	1	63	67	1	1108	28	-	16	-	-	22	6	62
SPZ 67-01	1	67	71	1	1108	28	-	16	-	-	22	6	62
SPZ 71-01	1	71	75	1	1108	28	-	16	-	-	22	6	62
SPZ 75-01	1	75	79	1	1108	28	-	16	-	-	22	6	62
SPZ 80-01	1	80	84	1	1210	32	-	16	-	-	25	9	75
SPZ 85-01	1	85	89	1	1210	32	-	16	-	-	25	9	75
SPZ 90-01	1	90	94	1	1210	32	-	16	-	-	25	-	75
SPZ 95-01	1	95	99	1	1210	32	-	16	-	-	25	6	75
SPZ 100-01	1	100	104	1	1210	32	-	16	-	-	25	6	75
SPZ 106-01	1	106	110	1	1610	42	-	16	-	-	25	6	80
SPZ 112-01	1	112	116	1	1610	42	-	16	-	-	25	6	80
SPZ 118-01	1	118	122	1	1610	42	-	16	-	-	25	6	80
SPZ 125-01	1	125	129	1	1610	42	-	16	-	-	25	6	80
SPZ 132-01	1	132	136	1	1610	42	-	16	-	-	25	6	80
SPZ 140-01	1	140	144	1	1610	42	-	16	-	-	25	6	80
SPZ 150-01	1	150	154	1	1610	42	-	16	-	-	25	6	80
SPZ 160-01	1	160	164	1	1610	42	-	16	-	-	25	6	80
SPZ 170-01	1	170	174	1	1610	42	-	16	-	-	25	6	80
SPZ 180-01	1	180	184	1	1610	42	-	16	-	-	25	6	80
SPZ 190-01	1	190	194	7	1610	42	-	16	161	-	25	6	80
SPZ 200-01	1	200	204	7	2012	50	-	16	172	-	32	16	100
SPZ 224-01	1	224	228	7	2012	50	15	16	196	-	32	16	100
SPZ 250-01	1	250	254	4	2012	50	-	16	222	8	32	8	100
SPZ 280-01	1	280	284	4	2012	50	-	16	252	8	32	8	100
SPZ 315-01	1	315	319	4	2012	50	-	16	287	8	32	8	100
SPZ 355-01	1	355	359	4	2012	50	-	16	326	8	32	8	112
SPZ 400-01	1	400	404	4	2012	50	-	16	371	8	32	8	112
SPZ 450-01	1	450	454	4	2517	60	-	16	421	14.5	45	14.5	120

Burçlu V Kayış Kasnakları

V Pulley With Taper Bush



SPZ / 2

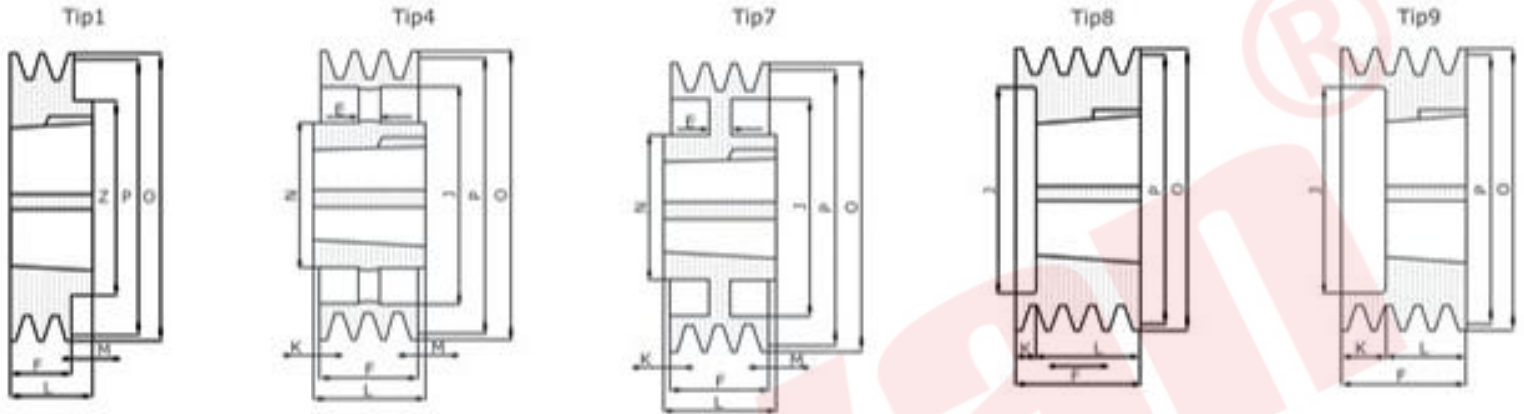

Kod (Code)	Kanal (Grooves)	P	O	Type (Type)	Burç (Bush)	Maks. Delik (Max. Bore)	E	F	J	K	L	M	N
SPZ 50-02	2	50	54	9	1008	25	-	49	28	27	22	-	-
SPZ 56-02	2	56	60	9	1108	28	-	49	35	27	22	-	-
SPZ 60-02	2	60	64	9	1108	28	-	49	36	27	22	-	-
SPZ 63-02	2	63	67	8	1108	28	-	28	40	6	22	-	-
SPZ 67-02	2	67	71	8	1108	28	-	28	42	6	22	-	-
SPZ 71-02	2	71	75	8	1108	28	-	28	42	6	22	-	-
SPZ 75-02	2	75	79	8	1210	32	-	28	51	3	25	-	-
SPZ 80-02	2	80	84	8	1210	32	-	28	51	3	25	-	-
SPZ 85-02	2	85	89	8	1610	32	-	28	60	3	25	-	-
SPZ 90-02	2	90	94	8	1610	32	-	28	61	3	25	-	-
SPZ 95-02	2	95	99	8	1610	32	-	28	66	3	25	-	-
SPZ 100-02	2	100	104	8	1610	32	-	28	71	3	25	-	-
SPZ 106-02	2	106	110	8	1610	32	-	28	76	3	25	-	-
SPZ 112-02	2	112	116	8	1610	32	-	28	84	3	25	-	-
SPZ 118-02	2	118	122	8	1610	32	-	28	90	3	25	-	-
SPZ 125-02	2	125	129	8	1610	32	-	28	97	3	25	-	-
SPZ 132-02	2	132	136	8	1610	32	-	28	104	3	25	-	-
SPZ 140-02	2	140	144	8	1610	32	-	28	112	3	25	-	-
SPZ 150-02	2	150	154	1	2012	50	-	28	-	-	32	4	100
SPZ 160-02	2	160	164	7	2012	50	-	28	-	-	32	4	100
SPZ 170-02	2	170	174	7	2012	50	-	28	-	-	32	4	100
SPZ 180-02	2	180	184	7	2012	50	10	28	152	-	32	4	100
SPZ 190-02	2	190	194	7	2012	50	10	28	161	-	32	4	100
SPZ 200-02	2	200	204	7	2012	50	10	28	171	-	32	4	100
SPZ 224-02	2	224	228	7	2012	50	10	28	196	-	32	4	100
SPZ 250-02	2	250	254	4	2012	50	-	28	222	2	32	2	100
SPZ 280-02	2	280	284	4	2012	50	-	28	252	2	32	2	100
SPZ 315-02	2	315	319	4	2012	50	-	28	286	2	32	2	100
SPZ 355-02	2	355	359	4	2012	50	-	28	326	2	32	2	112
SPZ 400-02	2	400	404	4	2517	60	-	28	371	8.5	45	8.5	120
SPZ 450-02	2	450	454	4	2517	60	-	28	421	8.5	45	8.5	120

Burçlu V Kayış Kasnakları

V Pulley With Taper Bush



SPZ / 3

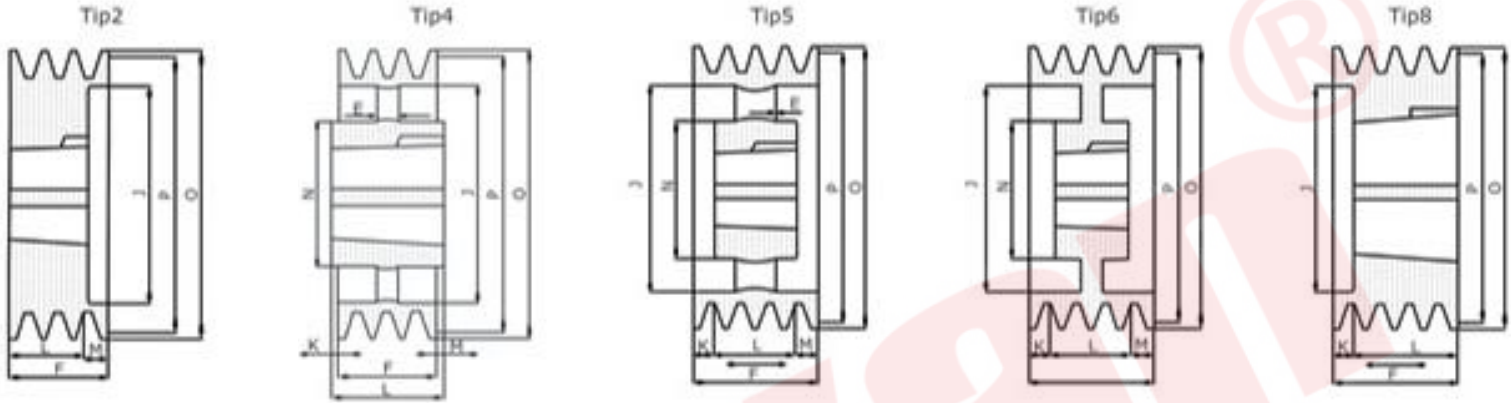

Kod (Code)	Kanal (Grooves)	P	O	Type (Type)	Burç (Bush)	Maks. Delik (Max. Bore)	E	F	J	K	L	M	N
SPZ 63-03	3	63	67	8	1108	28	-	40	40	18	22	-	-
SPZ 67-03	3	67	71	8	1108	28	-	40	42	18	22	-	-
SPZ 71-03	3	71	75	8	1108	28	-	40	42	18	22	-	-
SPZ 75-03	3	75	79	8	1210	32	-	40	48	15	25	-	-
SPZ 80-03	3	80	84	8	1210	32	-	40	51	15	25	-	-
SPZ 85-03	3	85	89	8	1610	42	-	40	60	15	25	-	-
SPZ 90-03	3	90	94	8	1610	42	-	40	61	15	25	-	-
SPZ 95-03	3	95	99	8	1610	42	-	40	66	15	25	-	-
SPZ 100-03	3	100	104	8	1610	42	-	40	71	15	25	-	-
SPZ 106-03	3	106	110	8	1610	42	-	40	78	15	25	-	-
SPZ 112-03	3	112	116	8	2012	50	-	40	84	8	32	-	-
SPZ 118-03	3	118	122	8	2012	50	-	40	92	8	32	-	-
SPZ 125-03	3	125	129	2	2012	50	-	40	97	-	32	8	-
SPZ 132-03	3	132	136	2	2012	50	-	40	104	-	32	8	-
SPZ 140-03	3	140	144	2	2012	50	-	40	112	-	32	8	-
SPZ 150-03	3	150	154	2	2012	50	-	40	122	-	32	8	-
SPZ 160-03	3	160	164	2	2012	50	-	40	132	-	32	8	-
SPZ 170-03	3	170	174	2	2012	50	-	40	141	-	32	4	-
SPZ 180-03	3	180	184	2	2012	50	-	40	152	-	32	8	-
SPZ 190-03	3	190	194	6	2012	50	20	40	161	4	32	4	100
SPZ 200-03	3	200	204	6	2012	50	20	40	172	4	32	4	100
SPZ 224-03	3	224	228	6	2012	50	20	40	196	4	32	4	100
SPZ 250-03	3	250	254	5	2012	50	-	40	222	4	32	4	100
SPZ 280-03	3	280	284	4	2517	60	-	40	252	2.5	45	2.5	120
SPZ 315-03	3	315	319	4	2517	60	-	40	287	2.5	45	2.5	120
SPZ 355-03	3	355	359	4	2517	60	-	40	326	2.5	45	2.5	120
SPZ 400-03	3	400	404	4	2517	60	-	40	371	2.5	45	2.5	120
SPZ 450-03	3	450	454	4	2517	60	-	40	421	2.5	45	2.5	120
SPZ 500-03	3	500	504	4	2517	60	-	40	471	2.5	45	2.5	120
SPZ 630-03	3	630	634	4	3020	75	-	40	601	5.5	51	2.5	120
SPZ 800-03	3	800	804	4	3020	75	-	40	771	5.5	51	2.5	150

Burçlu V Kayış Kasnakları

V Pulley With Taper Bush



SPZ / 4

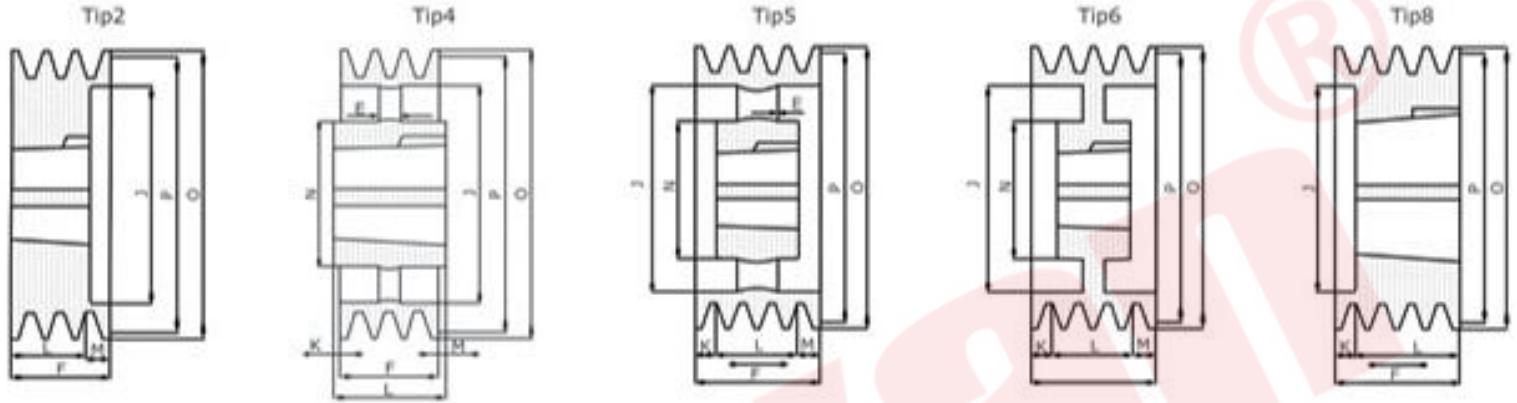

Kod (Code)	Kanal (Grooves)	P	O	Type (Type)	Burç (Bush)	Maks. Delik (Max. Bore)	E	F	J	K	L	M	N
SPZ 80-04	4	80	34	8	1210	32	-	52	51	27	25	-	-
SPZ 85-04	4	85	39	8	1610	42	-	52	60	27	25	-	-
SPZ 90-04	4	90	94	8	1610	42	-	52	61	27	25	-	-
SPZ 95-04	4	95	99	8	1610	42	-	52	66	27	25	-	-
SPZ 100-04	4	100	104	8	1610	42	-	52	72	27	25	-	-
SPZ 106-04	4	106	110	8	1610	42	-	52	80	27	25	-	-
SPZ 112-04	4	112	116	8	2012	50	-	52	86	27	32	-	-
SPZ 118-04	4	118	122	8	2012	50	-	52	92	20	32	-	-
SPZ 125-04	4	125	129	2	2012	50	-	52	99	20	32	20	-
SPZ 132-04	4	132	136	2	2012	50	-	52	104	7	32	20	-
SPZ 140-04	4	140	144	2	2012	50	-	52	112	7	32	20	-
SPZ 150-04	4	150	154	2	2517	60	-	52	122	-	45	7	-
SPZ 160-04	4	160	164	2	2517	60	-	52	132	-	45	7	-
SPZ 170-04	4	170	174	2	2517	60	-	52	141	-	45	7	-
SPZ 180-04	4	180	184	6	2517	60	-	52	152	3.5	45	7	-
SPZ 190-04	4	190	194	6	2517	60	10	52	161	3.5	45	3.5	120
SPZ 200-04	4	200	204	6	2517	60	10	52	172	3.5	45	3.5	120
SPZ 224-04	4	224	225	5	2517	60	10	52	196	3.5	45	3.5	120
SPZ 250-04	4	250	254	5	2517	60	-	52	222	3.5	45	3.5	120
SPZ 280-04	4	280	254	5	2517	60	-	52	252	3.5	45	3.5	120
SPZ 315-04	4	315	315	5	2517	60	-	52	287	3.5	45	3.5	120
SPZ 355-04	4	355	359	5	2517	60	-	52	326	3.5	45	3.5	120
SPZ 400-04	4	400	404	5	2517	60	-	52	371	3.5	45	3.5	120
SPZ 450-04	4	450	454	5	3020	75	-	52	421	0.5	51	0.5	150
SPZ 500-04	4	500	504	5	3020	75	-	52	471	0.5	51	0.5	150
SPZ 630-04	4	630	634	4	3030	75	-	52	601	12	76	12	150
SPZ 800-04	4	800	804	4	3030	75	-	52	771	12	76	12	150

Burçlu V Kayış Kasnakları

V Pulley With Taper Bush



SPZ / 5

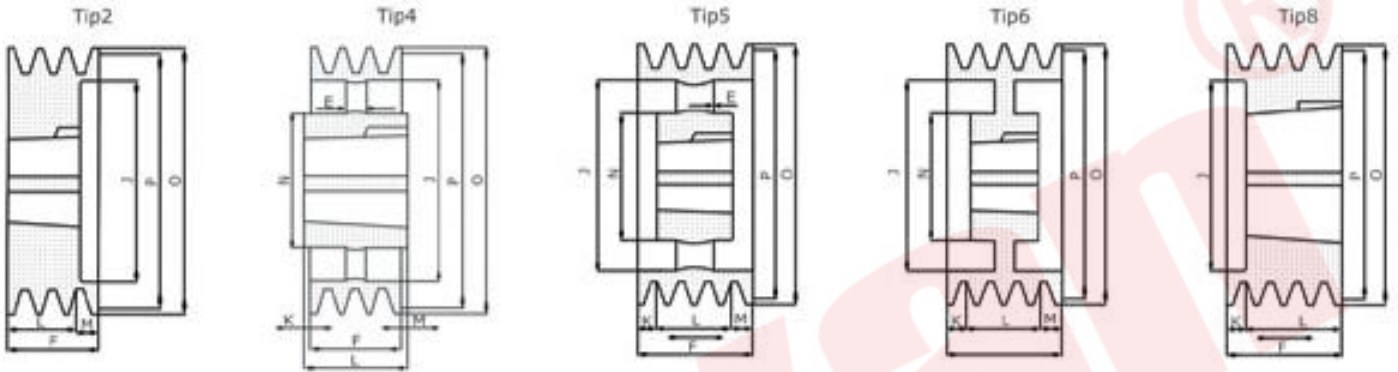

Kod (Code)	Kanal (Grooves)	P	O	Type (Type)	Burç (Bush)	Maks. Delik (Max. Bore)	E	F	J	K	L	M	N
SPZ 85-05	5	85	89	8	1610	42		64	60	39	25	-	-
SPZ 90-05	5	90	94	8	1610	42		64	61	39	25	-	-
SPZ 95-05	5	95	99	8	1610	42	-	64	66	39	25	-	-
SPZ 100-05	5	100	104	8	2012	42		64	72	32	32	-	-
SPZ 106-05	5	106	110	8	2012	50	-	64	73	32	32	-	-
SPZ 112-05	5	112	116	8	2012	50	-	64	84	32	32	-	-
SPZ 118-05	5	118	122	8	2012	50	-	64	90	32	32	-	-
SPZ 125-05	5	125	129	8	2012	50		64	97	32	32	20	-
SPZ 132-05	5	132	136	8	2517	50	-	64	104	19	45	20	-
SPZ 140-05	5	140	144	2	2517	60	-	64	112	-	45	20	-
SPZ 150-05	5	150	154	2	2517	60	-	64	122	-	45	7	-
SPZ 160-05	5	160	164	2	2517	60		64	132	-	45	7	-
SPZ 170-05	5	170	174	2	2517	60	-	64	141	-	45	7	-
SPZ 180-05	5	180	184	2	2517	60	-	64	152	-	45	7	-
SPZ 190-05	5	190	194	6	2517	60	10	64	161	9.5	45	3.5	-
SPZ 200-05	5	200	204	6	2517	60	10	64	172	9.5	45	3.5	-
SPZ 224-05	5	224	228	6	2517	60	10	64	196	9.5	45	3.5	120
SPZ 250-05	5	250	254	5	2517	60	-	64	222	9.5	45	3.5	120
SPZ 280-05	5	280	284	5	2517	60	-	64	252	9.5	45	3.5	120
SPZ 315-05	5	315	315	5	2517	60		64	237	9.5	45	3.5	120
SPZ 355-05	5	355	359	5	2517	60	-	64	326	9.5	45	3.5	120
SPZ 400-05	5	400	404	5	3020	60	-	64	371	6.5	51	3.5	150
SPZ 450-05	5	450	454	5	3020	75	-	64	421	6.5	51	0.5	150
SPZ 500-05	5	500	504	4	3030	75		64	471	6	76	0.5	150
SPZ 630-05	5	630	634	4	3030	75	-	64	601	6	76	12	150
SPZ 800-05	5	800	804	4	3535	90	-	64	771	12.5	39	12.5	170

Burçlu V Kayış Kasnakları

V Pulley With Taper Bush



SPZ / 6

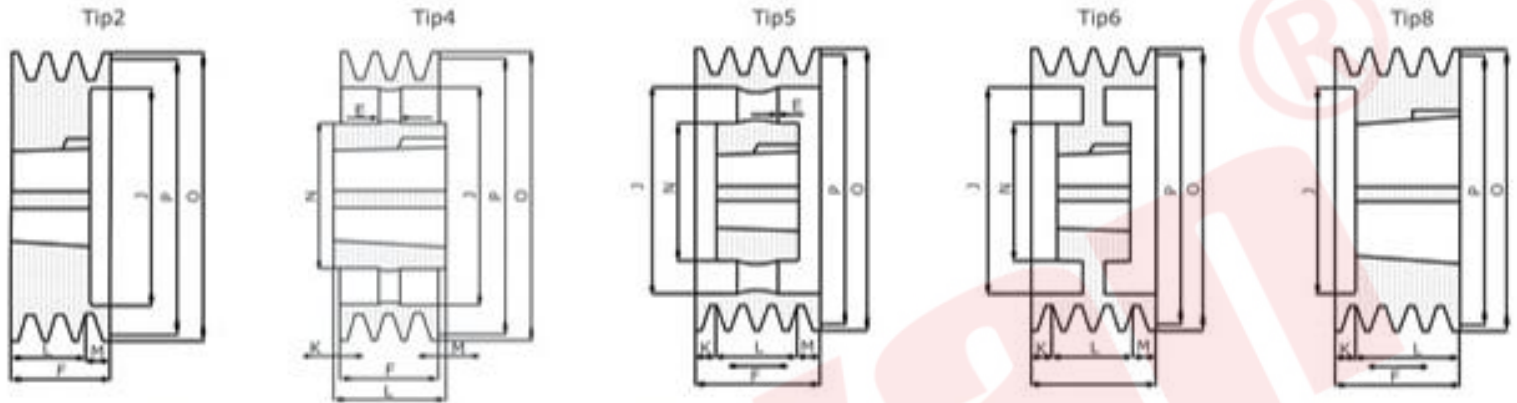

Kod (Code)	Kanal (Grooves)	P	O	Type (Type)	Burç (Bush)	Maks. Delik (Max. Bore)	E	F	J	K	L	M	N
SPZ 90-06	6	90	94	8	1610	42	-	76	61	51	25	-	-
SPZ 95-06	6	95	99	8	1610	42	-	76	66	51	25	-	-
SPZ 100-06	6	100	104	8	2012	50	-	76	72	44	32	-	-
SPZ 106-06	6	106	110	8	2012	50	-	76	78	44	32	-	-
SPZ 112-06	6	112	116	8	2012	50	-	76	84	44	32	-	-
SPZ 118-06	6	118	122	8	2517	60	-	76	90	31	32	-	-
SPZ 125-06	6	125	129	8	2517	60	-	76	97	31	32	-	-
SPZ 132-06	6	132	136	8	2517	60	-	76	104	31	45	-	-
SPZ 140-06	6	140	144	2	2517	60	-	76	112	-	45	31	-
SPZ 150-06	6	150	154	2	2517	60	-	76	122	-	45	31	-
SPZ 160-06	6	160	164	2	2517	60	-	76	132	-	45	31	-
SPZ 170-06	6	170	174	2	2517	60	-	76	141	-	45	31	-
SPZ 180-06	6	180	184	2	2517	60	-	76	152	-	45	31	-
SPZ 190-06	6	190	194	6	2517	60	10	76	161	15.5	45	15.5	120
SPZ 200-06	6	200	204	6	2517	60	10	76	172	15.5	45	15.5	120
SPZ 224-06	6	224	228	6	2517	60	10	76	196	15.5	45	15.5	120
SPZ 250-06	6	250	254	5	2517	60	-	76	222	15.5	45	15.5	120
SPZ 280-06	6	280	284	5	2517	60	-	76	252	15.5	45	15.5	120
SPZ 315-06	6	315	315	5	2517	60	-	76	287	15.5	45	15.5	120
SPZ 355-06	6	355	359	5	2517	60	-	76	326	15.5	45	15.5	125
SPZ 400-06	6	400	404	5	3030	75	-	76	371	-	51	-	150
SPZ 450-06	6	450	454	5	3030	75	-	76	421	-	51	-	150
SPZ 500-06	6	500	504	5	3030	75	-	76	471	-	76	-	150
SPZ 630-06	6	630	634	4	3535	90	-	76	601	6.5	76	6.5	170
SPZ 800-06	6	800	804	4	3535	90	-	76	771	6.5	39	6.5	170

Burçlu V Kayış Kasnakları

V Pulley With Taper Bush



SPZ / 8

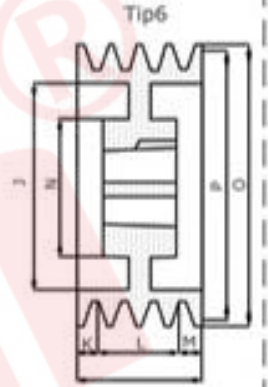
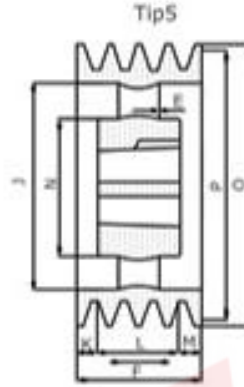
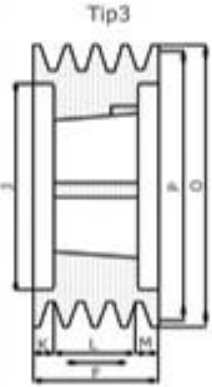

Kod (Code)	Kanal (Grooves)	P	O	Type (Type)	Burç (Bush)	Maks. Delik (Max. Bore)	E	F	J	K	L	M	N
SPZ 140-08	8	140	144	3	2517	60	-	100	112	27,5	45	27,5	-
SPZ 150-08	8	150	154	3	2517	60	-	100	122	27,5	45	27,5	-
SPZ 160-08	8	160	164	3	2517	60	-	100	132	27,5	45	27,5	-
SPZ 180-08	8	180	184	3	2517	60	-	100	152	27,5	45	27,5	-
SPZ 200-08	8	200	204	3	3020	75	-	100	171	24,5	51	24,5	-
SPZ 224-08	8	224	228	3	3020	75	-	100	195	24,5	51	24,5	-
SPZ 250-08	8	250	254	6	3020	75	-	100	221	24,5	51	24,5	150
SPZ 280-08	8	280	284	5	3020	75	-	100	252	24,5	51	24,5	150
SPZ 355-08	8	355	359	5	3030	75	-	100	326	12	76	12	150
SPZ 400-08	8	400	404	5	3030	75	-	100	371	12	76	12	150
SPZ 450-08	8	450	454	5	3035	90	-	100	421	5,5	39	5,5	170

Burçlu V Kayış Kasnakları

V Pulley With Taper Bush



SPA / 1

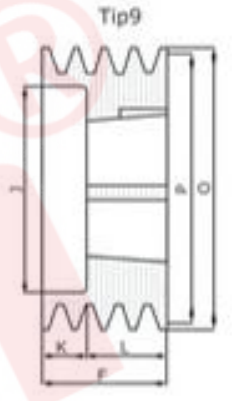
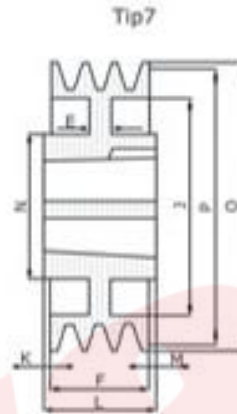
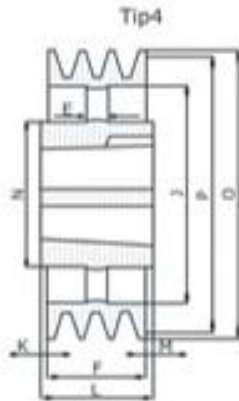
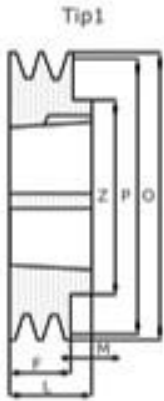

Kod (Code)	Kanal (Grooves)	P	O	Type (Type)	Burç (Bush)	Maks. Delik (Max. Bore)	E	F	J	K	L	M	N
SPA 63-01	1	63	68.5	9	1008	25	-	40	40	18	22	-	-
SPA 67-01	1	67	72.5	1	1108	28	-	40	42	18	22	-	-
SPA 71-01	1	71	76.5	1	1108	28	-	40	42	18	22	-	-
SPA 75-01	1	75	80.5	1	1108	28	-	40	48	15	25	-	-
SPA 80-01	1	80	85.5	1	1210	32	-	40	51	15	25	-	-
SPA 85-01	1	85	90.5	1	1210	32	-	40	60	15	25	-	-
SPA 90-01	1	90	95.5	1	1210	32	-	40	61	15	25	-	-
SPA 95-01	1	95	100.5	1	1210	32	-	40	66	15	25	-	-
SPA 100-01	1	100	105.5	1	1610	42	-	40	71	15	25	-	-
SPA 106-01	1	106	111.5	1	1610	42	-	40	78	15	25	-	-
SPA 112-01	1	112	117.5	1	1610	50	-	40	84	8	32	-	-
SPA 118-01	1	118	123.5	1	1610	50	-	40	92	8	32	-	-
SPA 125-01	1	125	130.5	1	1610	50	-	40	97	-	32	8	-
SPA 132-01	1	132	137.5	1	1610	50	-	40	104	-	32	8	-
SPA 140-01	1	140	145.5	1	1610	50	-	40	112	-	32	8	-
SPA 150-01	1	150	155.5	1	1610	50	-	40	122	-	32	8	-
SPA 160-01	1	160	165.5	1	1610	50	-	40	132	-	32	8	-
SPA 170-01	1	170	175.5	1	1610	50	-	40	141	-	32	4	-
SPA 180-01	1	180	185.5	1	1610	50	-	40	152	-	32	8	-
SPA 190-01	1	190	195.5	1	1610	50	20	40	161	4	32	4	100
SPA 200-01	1	200	205.5	7	2012	50	20	40	172	4	32	4	100
SPA 212-01	1	212	217.5	7	2012	50	20	40	196	4	32	4	100
SPA 224-01	1	224	229.5	7	2012	50	20	40	196	4	32	4	100
SPA 250-01	1	250	255.5	7	2012	50	-	40	222	4	32	4	100
SPA 280-01	1	280	285.5	7	2012	60	-	40	252	2.5	45	2.5	120
SPA 315-01	1	315	320.5	7	2012	60	-	40	287	2.5	45	2.5	120
SPA 355-01	1	355	360.5	4	2012	60	-	40	326	2.5	45	2.5	120
SPA 400-01	1	400	405.5	4	2012	60	-	40	371	2.5	45	2.5	120
SPA 450-01	1	450	455.5	4	2012	60	-	40	421	2.5	45	2.5	120
SPA 500-01	1	500	505.5	4	2517	60	-	40	471	2.5	45	2.5	120
SPA 630-01	1	630	635.5	4	2517	75	-	40	601	5.5	51	2.5	120

Burçlu V Kayış Kasnakları

V Pulley With Taper Bush



SPA / 2

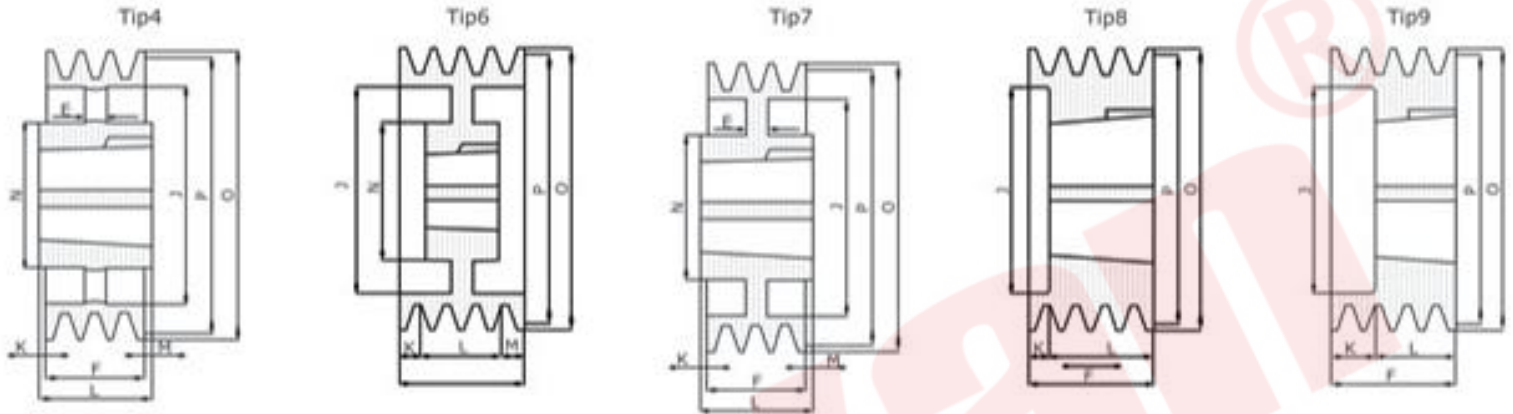

Kod (Code)	Kanal (Grooves)	P	O	Type (Type)	Burç (Bush)	Maks. Delik (Max. Bore)	E	F	J	K	L	M	N
SPA 63-02	2	63	68.5	9	1008	28	-	55	36	33	22	-	-
SPA 67-02	2	67	72.5	8	1108	28	-	35	37	13	22	-	-
SPA 71-02	2	71	76.5	8	1108	28	-	35	40	13	22	-	-
SPA 75-02	2	75	80.5	8	1108	28	-	35	44	10	25	-	-
SPA 80-02	2	80	85.5	8	1210	32	-	35	47	10	25	-	-
SPA 85-02	2	85	90.5	8	1210	32	-	35	50	10	25	-	-
SPA 90-02	2	90	95.5	8	1210	42	-	35	60	10	25	-	-
SPA 95-02	2	95	100.5	8	1210	42	-	35	64	10	25	-	-
SPA 100-02	2	100	105.5	8	1610	42	-	35	70	10	25	-	-
SPA 106-02	2	106	111.5	8	1610	42	-	35	76	10	25	-	-
SPA 112-02	2	112	117.5	8	1610	42	-	35	80	10	25	-	-
SPA 118-02	2	118	123.5	8	1610	42	-	35	86	10	25	-	-
SPA 125-02	2	125	130.5	8	1610	42	-	35	90	10	25	-	-
SPA 132-02	2	132	137.5	8	1610	50	-	35	98	3	32	-	-
SPA 140-02	2	140	145.5	8	1610	50	-	35	106	3	32	-	-
SPA 150-02	2	150	155.5	8	1610	50	-	35	116	3	32	-	-
SPA 160-02	2	160	165.5	8	1610	50	15	35	125	3	32	-	-
SPA 170-02	2	170	175.5	8	1610	50	15	35	135	3	32	-	-
SPA 180-02	2	180	185.5	6	1610	50	15	35	148	1,5	32	1,5	100
SPA 190-02	2	190	195.5	6	1610	50	15	35	158	1,5	32	1,5	100
SPA 200-02	2	200	205.5	7	2012	60	15	35	165	5	45	5	120
SPA 212-02	2	212	217.5	7	2012	60	15	35	177	5	45	5	120
SPA 224-02	2	224	229.5	7	2012	60	15	35	189	-	45	10	120
SPA 250-02	2	250	255.5	7	2012	60	20	35	215	5	45	5	120
SPA 280-02	2	280	285.5	7	2012	60	20	35	245	-	45	10	120
SPA 315-02	2	315	320.5	4	2012	60	-	35	280	-	45	10	120
SPA 355-02	2	355	360.5	4	2012	60	-	35	320	-	45	10	120
SPA 400-02	2	400	405.5	4	2012	60	-	35	365	-	45	10	120
SPA 450-02	2	450	455.5	4	2012	60	-	35	465	-	45	10	120
SPA 500-02	2	500	505.5	4	2517	60	-	35	525	-	51	16	150
SPA 630-02	2	630	635.5	4	2517	75	-	35	595	-	51	16	150

Burçlu V Kayış Kasnakları

V Pulley With Taper Bush



SPA / 3

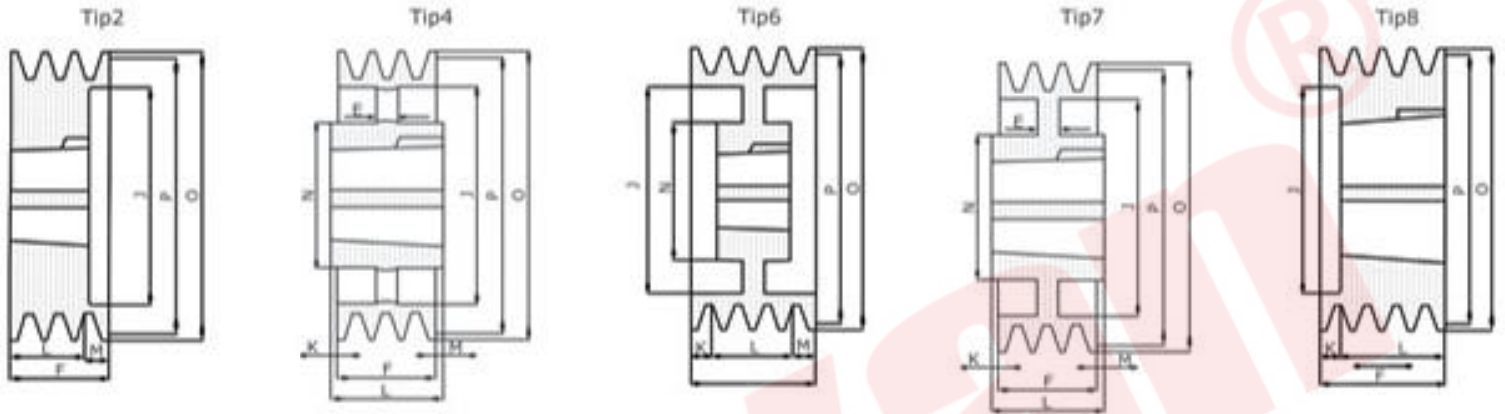

Kod (Code)	Kanal (Grooves)	P	O	Type (Type)	Burç (Bush)	Maks. Delik (Max. Bore)	E	F	J	K	L	M	N
SPA 71-03	3	71	76.5	8	1108	28	-	50	40	28	22	-	-
SPA 75-03	3	75	80.5	8	1210	32	-	50	44	25	25	-	-
SPA 80-03	3	80	85.5	8	1210	32	-	50	47	25	25	-	-
SPA 85-03	3	85	90.5	8	1210	32	-	50	50	25	25	-	-
SPA 90-03	3	90	95.5	8	1610	42	-	50	60	25	25	-	-
SPA 95-03	3	95	100.5	8	1610	42	-	50	64	25	25	-	-
SPA 100-03	3	100	105.5	2	1610	42	-	50	70	-	25	25	-
SPA 106-03	3	106	111.5	2	1610	42	-	50	76	-	32	25	-
SPA 112-03	3	112	117.5	8	2012	50	-	50	83	18	32	-	-
SPA 118-03	3	118	123.5	2	2012	50	-	50	86	-	32	18	-
SPA 125-03	3	125	130.5	2	2012	50	-	50	92	-	32	18	-
SPA 132-03	3	132	137.5	2	2012	50	-	50	98	-	45	18	-
SPA 140-03	3	140	145.5	8	2517	60	-	50	106	5	45	-	-
SPA 150-03	3	150	155.5	8	2517	60	-	50	116	5	45	-	-
SPA 160-03	3	160	165.5	8	2517	60	-	50	126	5	45	-	-
SPA 170-03	3	170	175.5	8	2517	60	-	50	138	5	45	-	-
SPA 180-03	3	180	185.5	8	2517	60	-	50	146	5	45	-	-
SPA 190-03	3	190	195.5	8	2517	60	-	50	158	5	45	-	-
SPA 200-03	3	200	205.5	6	2517	60	20	50	165	2,5	45	2,5	120
SPA 212-03	3	212	217.5	6	2517	60	20	50	177	2,5	45	2,5	120
SPA 224-03	3	224	229.5	6	2517	60	20	50	189	2,5	45	2,5	120
SPA 250-03	3	250	255.5	6	2517	60	20	50	215	2,5	45	2,5	120
SPA 280-03	3	280	285.5	6	2517	60	20	50	245	2,5	45	2,5	120
SPA 315-03	3	315	320.5	7	3020	75	25	50	280	0,5	51	0,5	160
SPA 355-03	3	355	360.5	4	3020	75	-	50	320	0,5	51	0,5	150
SPA 400-03	3	400	405.5	4	3020	75	-	50	365	0,5	51	0,5	150
SPA 450-03	3	450	455.5	4	3020	75	-	50	415	0,5	51	0,5	150
SPA 500-03	3	500	505.5	4	3020	75	-	50	465	0,5	51	0,5	150
SPA 560-03	3	560	565.5	4	3020	75	-	50	525	0,5	51	0,5	150
SPA 630-03	3	630	635.5	4	3535	75	-	50	595	0,5	51	0,5	150
SPA 800-03	3	800	805.5	4	3535	90	-	50	765	19,5	89	19,5	170
SPA1000-03	3	1000	1000.5	4	3535	90	-	50	965	19,5	89	19,5	172

Burçlu V Kayış Kasnakları

V Pulley With Taper Bush



SPA / 4

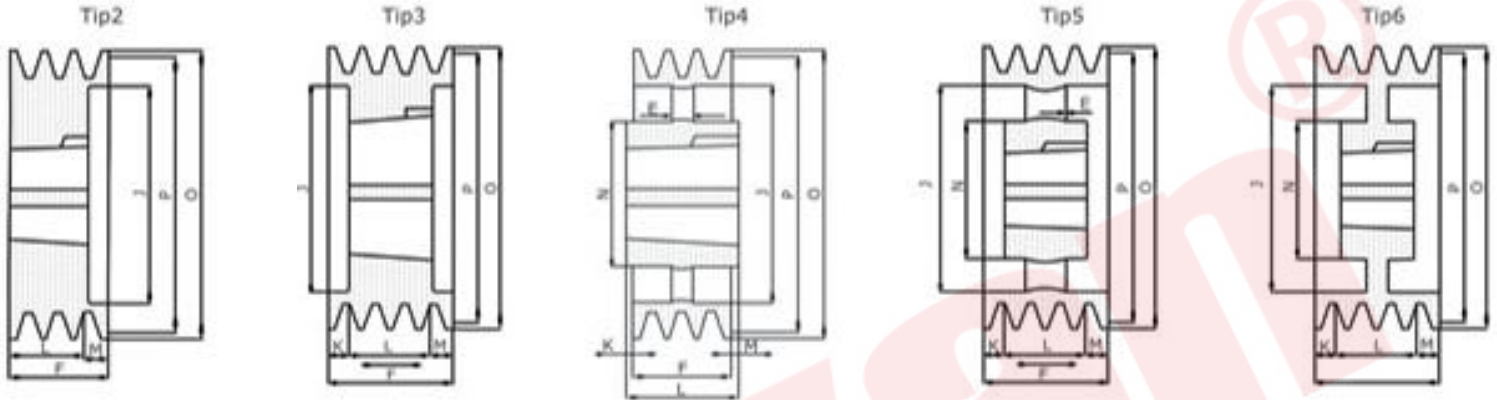

Kod (Code)	Kanal (Grooves)	P	O	Type (Type)	Burç (Bush)	Maks. Delik (Max. Bore)	E	F	J	K	L	M	N
SPA 90-04	4	90	95.5	3	1615	42	-	65	64	13.5	38	13,5	-
SPA 95-04	4	95	100.5	3	1615	42	-	65	64	13.5	38	13,5	-
SPA 100-04	4	100	105.5	2	1615	42	-	65	70	-	38	27	-
SPA 106-04	4	106	111.5	8	2012	32	-	65	76	33	32	-	-
SPA 112-04	4	112	117.5	8	2012	50	-	65	80	33	32	-	-
SPA 118-04	4	95	123.5	2	2012	50	-	65	86	-	32	33	-
SPA 125-04	4	118	130.5	2	2012	50	-	65	92	-	32	33	-
SPA 132-04	4	125	137.5	2	2517	60	-	65	98	-	45	20	-
SPA 140-04	4	132	145.5	2	2517	60	-	65	106	-	45	20	-
SPA 150-04	4	140	155.5	2	2517	60	-	65	116	-	45	20	-
SPA 160-04	4	150	165.5	2	2517	60	-	65	126	-	45	20	-
SPA 170-04	4	160	175.5	2	2517	60	-	65	138	-	45	20	-
SPA 180-04	4	170	185.5	2	2517	60	-	65	146	-	45	20	-
SPA 190-04	4	180	195.5	2	2517	60	-	65	158	-	45	20	-
SPA 200-04	4	190	205.5	2	3020	75	-	65	165	-	51	20	-
SPA 212-04	4	212	217.5	2	3020	75	-	65	177	-	51	20	-
SPA 224-04	4	224	229.5	2	3020	75	-	65	189	-	51	14	-
SPA 250-04	4	250	255.5	6	3020	75	10	65	215	7	51	14	150
SPA 280-04	4	280	285.5	6	3020	75	10	65	245	7	51	14	150
SPA 315-04	4	315	320.5	6	3020	75	10	65	280	7	51	7	150
SPA 355-04	4	355	360.5	5	3020	75	-	65	320	7	51	7	150
SPA 400-04	4	400	405.5	5	3020	75	-	65	365	7	51	7	150
SPA 450-04	4	450	455.5	5	3020	75	-	65	415	7	51	7	150
SPA 500-04	4	500	505.5	5	3020	75	-	65	465	7	51	7	150
SPA 560-04	4	560	565.5	4	3535	90	-	65	525	12	89	12	170
SPA 630-04	4	630	635.5	4	3535	90	-	65	595	12	89	12	170
SPA 800-04	4	800	805.5	4	3535	90	-	65	765	12	89	12	170
SPA 1000-04	4	1000	1005.5	4	3535	90	-	65	965	18.5	102	18,5	216

Burçlu V Kayış Kasnakları

V Pulley With Taper Bush



SPA / 5

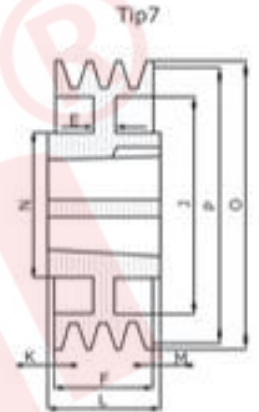
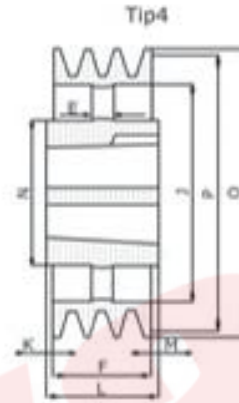
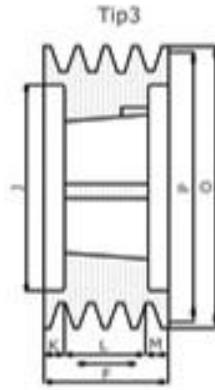
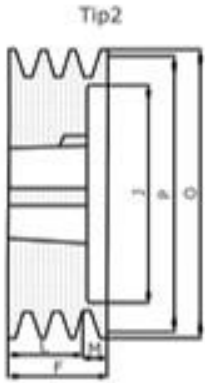

Kod (Code)	Kanal (Grooves)	P	O	Type (Type)	Burç (Bush)	Maks. Delik (Max. Bore)	E	F	J	K	L	M	N
SPA 100-05	5	100	105.5	2	1615	42	-	80	70	-	38	42	-
SPA 106-05	5	106	111.5	8	2012	50	-	80	76	48	32	-	-
SPA 112-05	5	112	117.5	8	2012	50	-	80	80	48	32	-	-
SPA 118-05	5	118	123.5	2	2012	50	-	80	86	-	32	48	-
SPA 125-05	5	125	130.5	3	2012	50	-	80	92	24	32	24	-
SPA 132-05	5	132	137.5	3	2517	60	-	80	98	17.5	45	17.5	-
SPA 140-05	5	140	145.5	3	2517	60	-	80	106	17.5	45	17.5	-
SPA 150-05	5	150	155.5	3	2517	60	-	80	116	17.5	45	17.5	-
SPA 160-05	5	160	165.5	3	2517	60	-	80	126	17.5	45	17.5	-
SPA 170-05	5	170	175.5	3	2517	60	-	80	146	17.5	45	17.5	-
SPA 180-05	5	180	185.5	3	3020	75	-	80	165	14.5	51	14.5	-
SPA 190-05	5	190	195.5	2	3020	75	-	80	189	-	51	29	-
SPA 200-05	5	200	205.5	3	3020	75	-	80	215	14.5	51	14.5	-
SPA 212-05	5	212	217.5	2	3020	75	-	80	245	-	51	29	-
SPA 224-05	5	224	229.5	2	3020	75	-	80	280	-	51	29	-
SPA 250-05	5	250	255.5	6	3020	75	10	80	215	14.5	51	14.5	150
SPA 280-05	5	280	285.5	7	3535	90	10	80	245	4.5	89	4.5	170
SPA 315-05	5	315	320.5	7	3535	90	12	80	280	4.5	89	4.5	170
SPA 355-05	5	355	360.5	4	3535	90	-	80	320	4.5	89	4.5	170
SPA 400-05	5	400	405.5	4	3535	90	-	80	365	4.5	89	4.5	170
SPA 450-05	5	450	455.5	4	3535	90	-	80	415	4.5	89	4.5	170
SPA 500-05	5	500	505.5	4	3535	90	-	80	465	4.5	89	4.5	170
SPA 560-05	5	560	565.5	4	3535	90	-	80	525	4.5	89	4.5	170
SPA 630-05	5	630	635.5	4	3535	90	-	80	595	4.5	89	4.5	170
SPA 800-05	5	800	805.5	4	4040	100	-	80	765	11	102	11	216
SPA1000-05	5	1000	1000.5	4	4545	110	-	80	965	17	114	17	225

Burçlu V Kayış Kasnakları

V Pulley With Taper Bush



SPA / 6

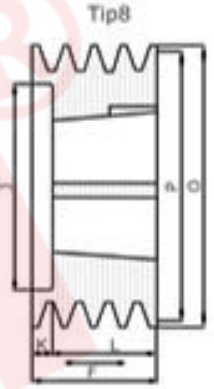
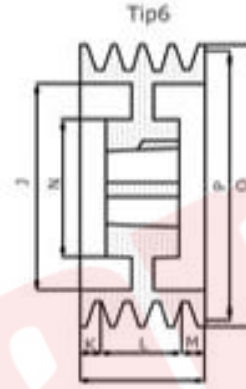
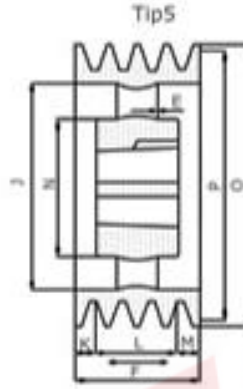
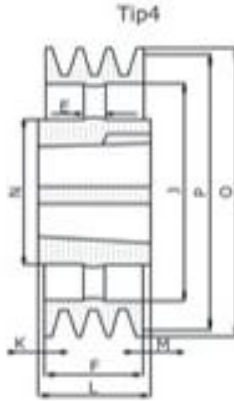
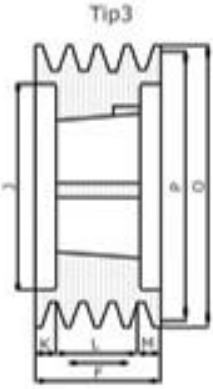

Kod (Code)	Kanal (Grooves)	P	O	Type (Type)	Burç (Bush)	Maks. Delik (Max. Bore)	E	F	J	K	L	M	N
SPA 100-06	6	100	105.5	3	1610	42	-	95	70	28.5	38	28.5	-
SPA 106-06	6	106	111.5	8	2012	50	-	95	76	63	32	-	-
SPA 112-06	6	112	117.5	8	2012	50	-	95	80	63	32	-	-
SPA 118-06	6	118	123.5	8	2012	50	-	95	86	63	32	-	-
SPA 125-06	6	125	130.5	3	2012	50	-	95	92	31.5	32	31.5	-
SPA 132-06	6	132	137.5	3	2517	60	-	95	98	25	45	25	-
SPA 140-06	6	140	145.5	3	2517	60	-	95	106	25	45	25	-
SPA 150-06	6	150	155.5	3	2517	60	-	95	116	25	45	25	-
SPA 160-06	6	160	165.5	3	2517	60	-	95	126	25	45	25	-
SPA 180-06	6	180	185.5	3	3020	75	-	95	146	22	51	22	-
SPA 200-06	6	200	205.5	3	3020	75	-	95	165	22	51	22	-
SPA 224-06	6	224	229.5	3	3020	75	-	95	189	22	51	22	-
SPA 250-06	6	250	255.5	6	3020	75	20	95	215	22	51	22	150
SPA 280-06	6	280	285.5	6	3535	90	25	95	245	3	89	3	170
SPA 315-06	6	315	320.5	6	3535	90	25	95	280	3	89	3	170
SPA 355-06	6	355	360.5	5	3535	90	-	95	320	3	89	3	170
SPA 400-06	6	400	405.5	5	3535	90	-	95	365	3	89	3	170
SPA 450-06	6	450	455.5	5	3535	90	-	95	415	3	89	3	170
SPA 500-06	6	500	505.5	5	3535	90	-	95	465	3	89	3	170
SPA 560-06	6	560	565.5	5	3535	90	-	95	525	3	89	3	170
SPA 630-06	6	630	635.5	4	4040	100	-	95	595	3.5	102	3.5	216
SPA 800-06	6	800	805.5	4	4040	100	-	95	765	3.5	102	3.5	216
SPA1000-06	6	1000	1000.5	4	4545	110	-	95	965	9.5	114	9.5	225

Burçlu V Kayış Kasnakları

V Pulley With Taper Bush



SPB / 1

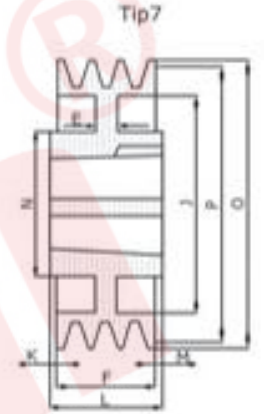
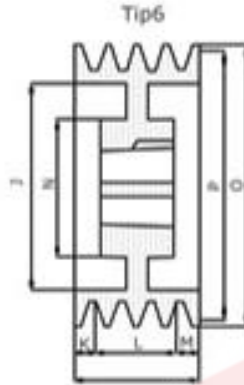
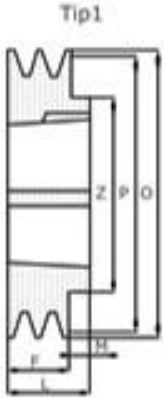

Kod (Code)	Kanal (Grooves)	P	O	Type (Type)	Burç (Bush)	Maks. Delik (Max. Bore)	E	F	J	K	L	M	N
SPB 100-01	1	100	107	1	1610	42	-	25	-	-	25	-	-
SPB 106-01	1	106	113	1	1610	42	-	25	-	-	25	-	-
SPB 112-01	1	112	119	1	1610	42	-	25	-	-	25	-	-
SPB118-01	1	118	125	1	1610	42	-	25	73	-	25	-	-
SPB 125-01	1	125	132	1	1610	42	-	25	-	-	25	-	-
SPB 132-01	1	132	139	1	1610	42	-	25	-	-	25	-	-
SPB 140-01	1	140	147	1	1610	42	-	25	-	-	25	-	-
SPB 150-01	1	150	157	1	1610	42	-	25	-	-	25	-	-
SPB 160-01	1	160	167	1	1610	42	-	25	-	-	25	-	-
SPB 170-01	1	170	177	1	1610	42	-	25	-	-	25	-	-
SPB 180-01	1	180	187	6	1610	42	10	25	137	-	25	-	80
SPB 190-01	1	190	197	7	2012	50	10	25	147	3.5	32	3.5	100
SPB 200-01	1	200	207	7	2012	50	10	25	157	3.5	32	3.5	100
SPB 212-01	1	212	219	7	2012	50	10	25	169	3.5	32	3.5	100
SPB 224-01	1	224	231	7	2012	50	10	25	181	3.5	32	3.5	100
SPB 236-01	1	236	243	7	2012	50	10	25	193	3.5	32	3.5	100
SPB 250-01	1	250	257	7	2012	50	10	25	207	3.5	32	3.5	100
SPB 280-01	1	280	287	7	2012	50	10	25	237	3.5	32	3.5	100
SPB 300-01	1	300	307	7	2012	50	10	25	258	3.5	32	3.5	100
SPB 315-01	1	315	322	7	2012	50	10	25	272	3.5	32	3.5	100

Burçlu V Kayış Kasnakları

V Pulley With Taper Bush



SPB / 2

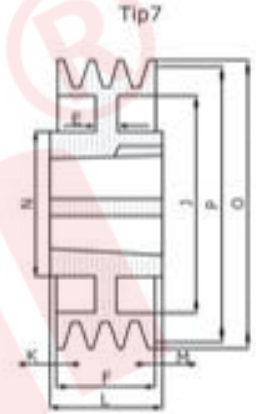
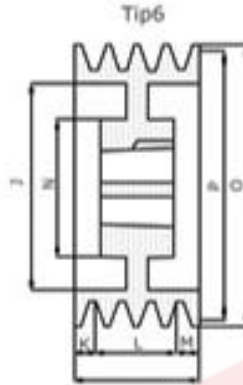
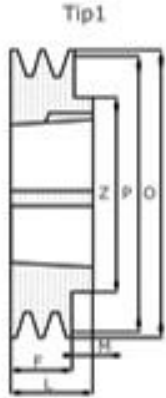

Kod (Code)	Kanal (Grooves)	P	O	Type (Type)	Burç (Bush)	Maks. Delik (Max. Bore)	E	F	J	K	L	M	N
SPB 100-02	2	100	107	2	1610	42	-	44	62	-	25	19	-
SPB 106-02	2	106	113	2	1610	42	-	44	67	-	25	19	-
SPB 112-02	2	112	119	2	1610	42	-	44	72	-	25	19	-
SPB 118-02	2	118	125	2	1610	42	-	44	73	-	25	19	-
SPB 125-02	2	125	132	2	2012	50	-	44	32	-	32	12	-
SPB 132-02	2	132	139	2	2012	50	-	44	39	-	32	12	-
SPB 140-02	2	140	147	2	2012	50	-	44	97	-	32	12	-
SPB 150-02	2	150	157	2	2012	50	-	44	107	-	32	12	-
SPB 160-02	2	160	167	2	2012	50	-	44	117	-	32	12	-
SPB 170-02	2	170	177	2	2012	50	-	44	127	-	32	12	-
SPB 180-02	2	180	187	1	2517	60	-	44	-	-	45	1	120
SPB 190-02	2	190	197	1	2517	60	-	44	-	-	45	1	120
SPB 200-02	2	200	207	1	2517	60	-	44	-	-	45	1	120
SPB 212-02	2	212	219	7	2517	60	10	44	169	-	45	1	120
SPB 224-02	2	224	231	7	2517	60	10	44	181	-	45	1	120
SPB 236-02	2	236	243	7	2517	60	10	44	193	-	45	1	120
SPB 250-02	2	250	257	7	2517	60	10	44	207	-	45	1	120
SPB 250-02	2	280	257	7	2517	60	12	44	237	-	45	1	120
SPB 300-02	2	300	307	7	2517	60	12	44	257	-	45	1	120
SPB 315-02	2	315	322	7	2517	60	12	44	272	-	45	1	120
SPB 335-02	2	335	342	7	2517	60	12	44	292	-	45	1	120
SPB 355-02	2	355	362	4	3020	75	-	44	312	3.5	51	3.5	120
SPB 400-02	2	400	407	4	3020	75	-	44	357	3.5	51	3.5	150
SPB 450-02	2	450	457	4	3020	75	-	44	407	3.5	51	3.5	150
SPB 500-02	2	500	507	4	3020	75	-	44	457	3.5	51	3.5	150
SPB 560-02	2	560	567	4	3030	75	-	44	517	4	76	23	150
SPB 630-02	2	630	637	4	3030	75	-	44	587	4	76	16	150

Burçlu V Kayış Kasnakları

V Pulley With Taper Bush



SPB / 3

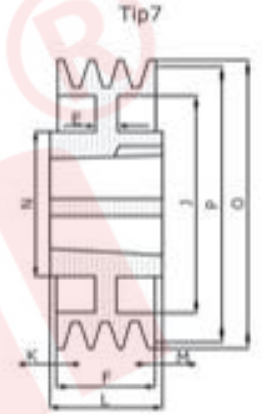
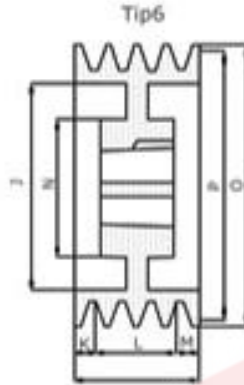
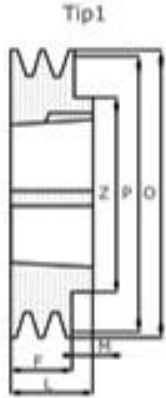

Kod (Code)	Kanal (Grooves)	P	O	Type (Type)	Burç (Bush)	Maks. Delik (Max. Bore)	E	F	J	K	L	M	N
SPB 100-03	3	100	107	2	1610	42	-	63	57	-	25	33	-
SPB 106-03	3	106	113	2	1610	42	-	63	67	-	25	33	-
SPB 112-03	3	112	119	2	1610	42	-	63	72	-	25	33	-
SPB 118-03	3	118	125	2	1610	42	-	63	73	-	25	33	-
SPB 125-03	3	125	132	2	2012	50	-	63	32	-	32	31	-
SPB 132-03	3	132	139	2	2012	50	-	63	39	-	32	31	-
SPB 140-03	3	140	147	2	2012	50	-	63	97	-	32	31	-
SPB 150-03	3	150	157	2	2517	60	-	63	107	-	45	13	-
SPB 160-03	3	160	167	2	2517	60	-	63	117	-	45	13	-
SPB 170-03	3	170	177	2	2517	60	-	63	127	-	45	13	-
SPB 180-03	3	180	187	2	2517	60	-	63	137	-	45	13	-
SPB 190-03	3	190	197	2	2517	60	15	63	147	-	45	13	-
SPB 200-03	3	200	207	2	2517	60	15	63	157	-	45	13	-
SPB 212-03	3	212	219	6	2517	60	15	36	169	-	45	13	120
SPB 224-03	3	224	231	6	2517	60		63	181	-	45	13	120
SPB 236-03	3	236	243	6	2517	60		63	193	-	45	13	120
SPB 250-03	3	250	257	6	3020	75	20	63	207	-	51	12	150
SPB 280-03	3	280	287	6	3020	75	20	63	237	6	51	6	150
SPB 300-03	3	300	307	6	3020	75	20	63	257	6	51	6	150
SPB 315-03	3	315	322	6	3020	75	20	63	272	6	51	6	150
SPB 335-03	3	335	342	6	3020	75	20	63	292	6	51	6	150
SPB 355-03	3	355	362	5	3020	75	15	63	312	6	51	6	150
SPB 400-03	3	400	407	4	3535	90	-	63	357	13	39	13	170
SPB 450-03	3	450	457	4	3535	90	-	63	407	-	39	26	170
SPB 500-03	3	500	507	4	3535	90	-	63	457	-	39	26	170
SPB 560-03	3	560	567	4	3535	90	-	63	517	-	39	26	170
SPB 630-03	3	630	637	4	3535	90	-	63	587	-	39	26	170
SPB 710-03	3	710	717	4	3535	90		63	664	4	39	22	170
SPB 800-03	3	800	807	4	3535	90		63	754	4	39	22	170
SPB 900-03	3	900	907	4	3535	90		63	854	4	39	22	170
SPB 1000-03	3	1000	1007	4	4040	100		63	954	6	102	33	200
SPB 1250-03	3	1250	1257	4	4040	100		63	1204	6	102	33	200

Burçlu V Kayış Kasnakları

V Pulley With Taper Bush



SPB / 4

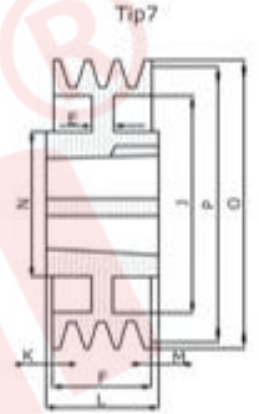
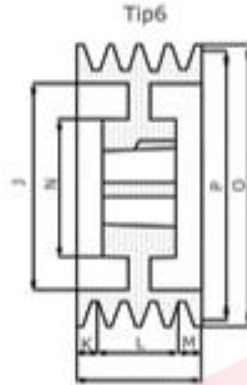
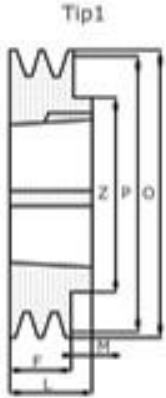

Kod (Code)	Kanal (Grooves)	P	O	Type (Type)	Burç (Bush)	Maks. Delik (Max. Bore)	E	F	J	K	L	M	N
SPB 125-04	4	125	132	3	2012	50	-	82	82	25	32	25	-
SPB 132-04	4	132	139	3	2012	50	-	82	89	25	32	25	-
SPB 140-04	4	140	147	3	2517	60	-	82	97	18.5	45	18.5	-
SPB 150-04	4	150	157	3	2517	60	-	82	107	18.5	45	18.5	-
SPB 160-04	4	160	167	3	2517	60	-	82	117	18.5	45	18.5	-
SPB 170-04	4	170	177	3	2517	60	-	82	127	18.5	45	18.5	-
SPB 180-04	4	180	187	3	2517	60	-	82	137	18.5	45	18.5	-
SPB 190-04	4	190	197	3	2517	60	-	82	147	18.5	45	18.5	-
SPB 200-04	4	200	207	3	3020	75	-	82	157	15.5	51	15.5	-
SPB 212-04	4	212	219	3	3020	75	-	82	169	15.5	51	15.5	-
SPB 224-04	4	224	231	3	3020	75	-	82	181	15.5	51	15.5	-
SPB 236-04	4	236	243	3	3020	75	-	82	193	15.5	51	15.5	-
SPB 250-04	4	250	257	6	3020	75	25	82	207	15.5	51	15.5	150
SPB 280-04	4	280	287	6	3020	75	25	82	237	15.5	51	15.5	150
SPB 300-04	4	300	307	6	3535	90	25	82	257	15.5	89	7	150
SPB 315-04	4	315	322	7	3535	90	25	82	272	3.5	89	3.5	170
SPB 335-04	4	335	342	7	3535	90	25	82	292	3.5	89	3.5	170
SPB 355-04	4	355	362	7	3535	90	25	82	312	3.5	89	3.5	170
SPB 400-04	4	400	407	4	3535	90	-	82	357	3.5	89	3.5	170
SPB 450-04	4	450	457	4	3535	90	-	82	407	-	89	7	170
SPB 500-04	4	500	507	4	3535	90	-	82	457	-	89	7	170
SPB 560-04	4	560	567	4	3535	90	-	82	517	-	89	7	170
SPB 630-04	4	630	637	4	3535	90	-	82	587	-	89	7	170
SPB 710-04	4	710	717	4	3535	90	-	82	664	3.5	89	3.5	187
SPB 800-04	4	800	807	4	4040	100	-	82	754	10	102	10	200
SPB 900-04	4	900	907	4	4040	100	-	82	854	10	102	10	216
SPB 1000-04	4	1000	1007	4	4040	100	-	82	954	10	102	10	216
SPB 1250-04	4	1250	1257	4	4545	110	-	82	1204	16	114	16	225

Burçlu V Kayış Kasnakları

V Pulley With Taper Bush



SPB / 5

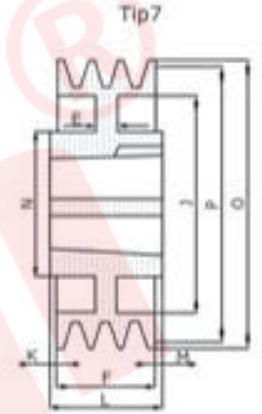
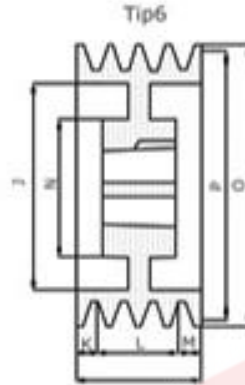
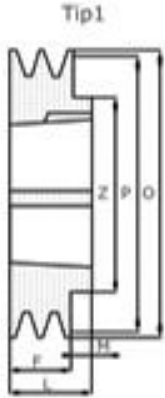

Kod (Code)	Kanal (Grooves)	P	O	Type (Type)	Burç (Bush)	Maks. Delik (Max. Bore)	E	F	J	K	L	M	N
SPB 125-05	5	125	132	S	2012	50	-	101	37	69	32	-	-
SPB 132-05	5	132	139	S	2517	60	-	101	94	56	45	-	-
SPB 140-05	5	140	147	3	2517	60	-	101	97	23	45	23	-
SPB 150-05	5	150	157	3	2517	60	-	101	107	23	45	23	-
SPB 160-05	5	160	167	3	2517	60	-	101	117	23	45	23	-
SPB 170-05	5	170	177	3	3020	75	-	101	127	25	51	25	-
SPB 180-05	5	180	187	3	3020	75	-	101	137	25	51	25	-
SPB 190-05	5	190	197	3	3020	75	-	101	147	25	51	25	-
SPB 200-05	5	200	207	3	3020	75	-	101	157	25	51	25	-
SPB 212-05	5	212	219	3	3020	75	-	101	169	25	51	25	-
SPB 224-05	5	224	231	3	3020	75	-	101	181	25	51	25	-
SPB 236-05	5	236	243	3	3535	90	-	101	193	6	39	6	-
SPB 250-05	5	250	257	3	3535	90	-	101	207	6	39	6	-
SPB 280-05	5	280	257	6	3535	90	25	101	237	6	39	6	170
SPB 300-05	5	300	307	6	3535	90	25	101	257	6	39	6	170
SPB 315-05	5	315	322	6	3535	90	25	101	272	6	39	6	170
SPB 335-05	5	335	342	6	3535	90	25	101	292	6	39	6	170
SPB 355-05	5	355	362	6	3535	90	17	101	312	6	39	6	170
SPB 400-05	5	400	407	5	3535	90	-	101	357	6	39	6	170
SPB 450-05	5	450	457	5	3535	90	-	101	407	-	39	12	170
SPB 500-05	5	500	507	5	3535	90	-	101	457	-	39	12	200
SPB 560-05	5	560	567	4	4040	100	-	101	517	-	102	1	200
SPB 630-05	5	630	637	4	4040	100	-	101	587	-	102	1	200
SPB 710-05	5	710	717	4	4040	100	-	101	664	0.5	102	0.5	200
SPB 800-05	5	800	807	4	4040	100	-	101	754	0.5	102	0.5	200
SPB 900-05	5	900	907	4	4040	100	-	101	854	6.5	114	6.5	200
SPB 1000-05	5	1000	1007	4	4545	110	-	101	954	6.5	114	6.5	225
SPB 1250-05	5	1250	1257	4	4545	110	-	101	1204	6.5	114	6.5	225

Burçlu V Kayış Kasnakları

V Pulley With Taper Bush



SPB / 6

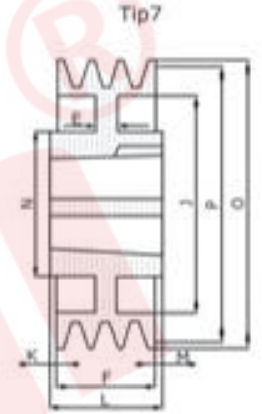
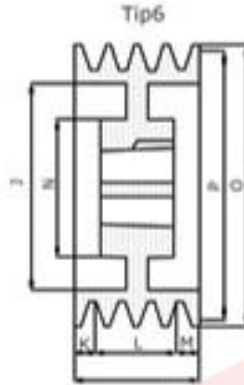
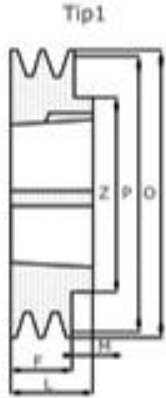

Kod (Code)	Kanal (Grooves)	P	O	Type (Type)	Burç (Bush)	Maks. Delik (Max. Bore)	E	F	J	K	L	M	N
SPB 140-06	6	140	147	3	2517	60	-	120	97	37.5	45	37.5	-
SPB 150-06	6	150	157	3	2517	60	-	120	107	37.5	45	37.5	-
SPB 160-06	6	160	167	3	3020	75	-	120	117	34.5	51	34.5	-
SPB 170-06	6	170	177	3	3020	75	-	120	127	34.5	51	34.5	-
SPB 180-06	6	180	137	3	3020	75	-	120	137	34.5	51	34.5	-
SPB 190-06	6	190	197	3	3020	75	-	120	147	34.5	51	34.5	-
SPB 200-06	6	200	207	3	3020	75	-	120	157	34.5	51	34.5	-
SPB 212-06	6	212	219	3	3535	90	-	120	169	15.5	39	15.5	-
SPB 224-06	6	224	231	3	3535	90	-	120	131	15.5	39	15.5	-
SPB 236-06	6	236	243	3	3535	90	-	120	193	15.5	39	15.5	-
SPB 250-06	6	250	257	3	3535	90	-	120	207	15.5	39	15.5	-
SPB 280-06	6	280	237	6	3535	90	13	120	237	15.5	39	15.5	170
SPB 300-06	6	300	307	6	3535	90	13	120	257	15.5	39	15.5	170
SPB 315-06	6	315	322	6	3535	90	13	120	272	15.5	39	15.5	170
SPB 335-06	6	335	342	6	3535	90	13	120	292	15.5	39	15.5	170
SPB 355-06	6	355	362	6	3535	90	13	120	312	15.5	39	15.5	170
SPB 400-06	6	400	407	5	3535	90	-	120	357	15.5	39	15.5	170
SPB 450-06	6	450	457	5	4040	100	-	120	407	-	39	13	200
SPB 500-06	6	500	507	5	4040	100	-	120	457	-	39	13	200
SPB 560-06	6	560	567	5	4040	100	-	120	517	-	102	13	200
SPB 630-06	6	630	637	5	4040	100	-	120	537	-	102	13	200
SPB 710-06	6	710	717	5	4040	100	-	120	664	9	102	9	216
SPB 800-06	6	800	307	5	4545	110	-	120	754	3	114	3	225
SPB 900-06	6	900	907	5	4545	110	-	120	354	3	114	3	225
SPB 1000-06	6	1000	1007	5	4545	110	-	120	954	3	114	3	225
SPB 1250-06	6	1250	1257	4	4545	110	-	120	1204	3.5	127	3.5	245

Burçlu V Kayış Kasnakları

V Pulley With Taper Bush



SPB / 8

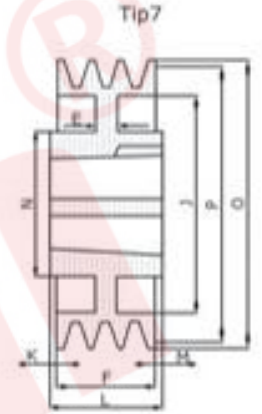
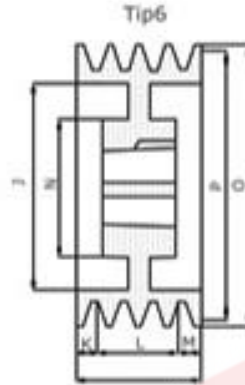
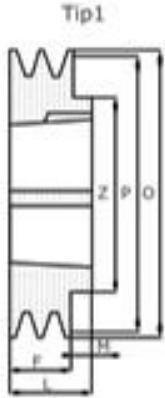

Kod (Code)	Kanal (Grooves)	P	O	Type (Type)	Burç (Bush)	Maks. Delik (Max. Bore)	E	F	J	K	L	M	N
SPB 140-08	8	140	147	3	2517	50	-	158	97	56.5	45	56.5	-
SPB 160-08	8	160	167	3	3020	75	-	158	117	53.5	51	53.5	-
SPB 170-08	8	170	177	3	3030	75	-	158	127	41	76	41	-
SPB 180-05	8	180	187	3	3030	75	-	158	137	41	76	41	-
SPB 190-08	8	190	197	3	3030	75	-	158	147	41	76	41	-
SPB 200-08	8	200	207	3	3535	90	-	158	157	34.5	39	34.5	-
SPB 212-08	8	212	219	3	3535	90	-	158	169	34.5	39	34.5	-
SPB 224-08	8	224	231	3	3535	90	-	158	181	34.5	39	34.5	-
SPB 236-08	8	236	243	3	3535	90	-	158	193	34.5	39	34.5	-
SPB 250-08	8	250	257	3	3535	90	-	158	207	34.5	39	34.5	-
SPB 280-08	8	280	257	3	3535	90	-	158	237	34.5	39	34.5	-
SPB 300-08	8	300	307	6	3535	90	20	158	257	34.5	39	34.5	170
SPB 315-08	8	315	322	6	3535	90	18	158	272	34.5	39	34.5	170
SPB 335-08	8	335	342	6	3535	90	18	158	292	34.5	39	34.5	170
SPB 355-08	8	355	362	6	3535	90	18	158	312	34.5	39	34.5	170
SPB 400-08	8	400	407	5	4040	100	-	158	357	23	102	23	200
SPB 450-08	8	450	457	5	4040	100	-	158	407	23	102	23	200
SPB 500-08	8	500	507	5	4040	100	-	158	457	23	102	23	200
SPB 560-08	8	560	567	5	4545	110	-	158	517	22	114	22	225
SPB 630-08	8	630	637	5	4545	110	-	158	587	22	114	22	225
SPB 710-08	8	710	717	5	4545	110	-	158	664	22	114	22	225
SPB 800-08	8	300	807	5	4545	110	-	158	754	22	114	22	225
SPB 900-08	8	900	907	5	4545	110	-	158	854	22	114	22	225
SPB 1000-08	8	1000	1007	5	5050	125	-	158	954	15.5	127	15.5	245
SPB 1250-08	8	1250	1257	4	5050	125	-	158	1204	15.5	127	15.5	245

Burçlu V Kayış Kasnakları

V Pulley With Taper Bush



SPB / 10

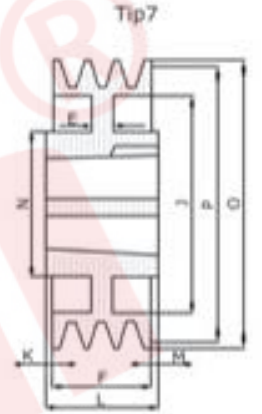
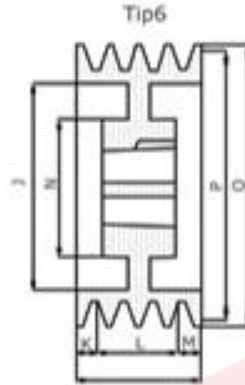
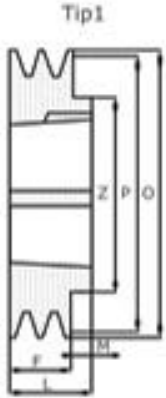

Kod (Code)	Kanal (Grooves)	P	O	Type (Type)	Burç (Bush)	Maks. Delik (Max. Bore)	E	F	J	K	L	M	N
SPB 224-10	10	224	231	3	3535	90	-	196	181	53.5	39	53.5	-
SPB 236-10	10	236	243	3	3535	90	-	196	193	53.5	39	53.5	-
SPB 250-10	10	250	257	3	3535	90	-	196	207	53.5	39	53.5	-
SPB 280-10	10	280	287	3	3535	90	-	196	237	53.5	39	53.5	-
SPB 315-10	10	315	322	6	3535	90	18	196	272	53.5	39	53.5	170
SPB 335-10	10	335	342	6	4040	100	20	196	292	47	102	47	200
SPB 355-10	10	355	362	6	4040	100	20	196	312	47	102	47	200
SPB 400-10	10	400	407	5	4040	100	-	196	357	47	102	47	200
SPB 450-10	10	450	457	5	4545	110	-	196	407	41	114	41	225
SPB 500-10	10	500	507	5	4545	110	-	196	457	41	114	41	225
SPB 560-10	10	560	567	5	4545	110	-	196	517	41	114	41	225
SPB 630-10	10	630	637	5	4545	110	-	196	587	41	114	41	225
SPB 710-10	10	710	717	5	4545	110	-	196	664	41	114	41	225
SPB 800-10	10	800	807	5	4545	110	-	196	754	41	114	41	225
SPB 900-10	10	900	907	5	4545	110	-	196	854	34.5	127	34.5	245
SPB 1000-10	10	1000	1007	5	5050	125	-	196	954	34.5	127	34.5	245

Burçlu V Kayış Kasnakları

V Pulley With Taper Bush



SPC / 3

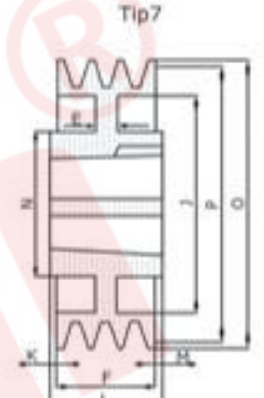
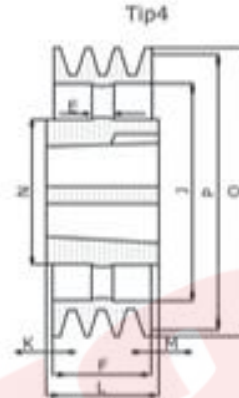
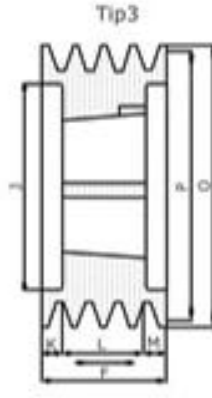
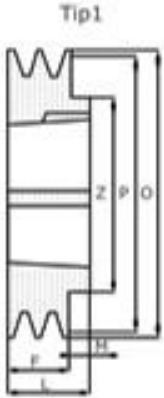

Kod (Code)	Kanal (Grooves)	P	O	Type (Type)	Burç (Bush)	Maks. Delik (Max. Bore)	E	F	J	K	L	M	N
SPC 200-03	3	200	209.6	3	2517	60	85	150	20	45	20	-	-
SPC 212-03	3	212	221.6	3	3020	75	85	162	17	51	17	-	-
SPC 224-03	3	224	233.6	3	3020	75	85	173	17	51	17	-	-
SPC 236-03	3	236	245.6	3	3020	75	85	185	17	51	17	-	-
SPC 250-03	3	250	259.6	3	3020	75	85	200	17	51	17	-	-
SPC 265-03	3	265	274.6	1	3535	90	85	209	-	89	4	170	-
SPC 280-03	3	280	289.6	1	3535	90	85	224	-	89	4	170	-
SPC 300-03	3	300	309.6	7	3535	90	85	249	2	89	2	170	18
SPC 315-03	3	315	324.6	7	3535	90	85	264	2	89	2	170	18
SPC 335-03	3	335	344.6	7	3535	90	85	284	2	89	2	170	18
SPC 355-03	3	355	364.6	7	3535	90	85	304	2	89	2	170	18
SPC 375-03	3	375	384.6	7	3535	90	85	324	2	89	2	170	20
SPC 400-03	3	400	409.6	4	3535	90	85	344	2	89	2	170	-
SPC 425-03	3	425	434.6	4	3535	90	85	369	2	89	2	170	-
SPC 450-03	3	450	459.6	4	3535	90	85	394	2	89	2	170	-
SPC 475-03	3	475	484.6	4	3535	90	85	419	2	89	2	170	-
SPC 500-03	3	500	509.6	4	3535	90	85	444	2	89	2	170	-
SPC 530-03	3	530	539.6	4	3535	90	85	474	2	89	2	170	-
SPC 560-03	3	560	569.6	4	3535	90	85	504	2	89	2	170	-
SPC 630-03	3	630	639.6	4	4040	100	85	574	8.5	102	8.5	200	-
SPC 800-03	3	800	809.6	4	4545	110	85	737	14.5	114	14.5	225	-
SPC 1000-03	3	1000	1009.6	4	5050	125	85	937	21	127	21	245	-
SPC 1250-03	3	1250	1259.6	4	5050	125	85	1187	21	127	21	245	-

Burçlu V Kayış Kasnakları

V Pulley With Taper Bush



SPC / 4

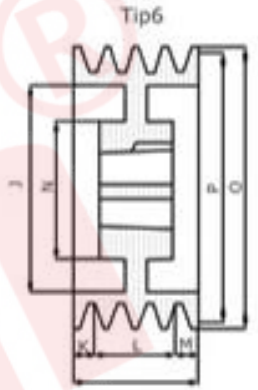
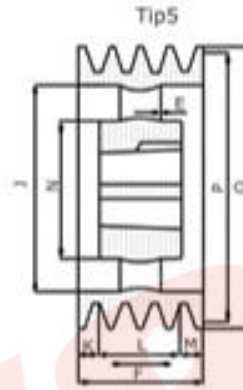
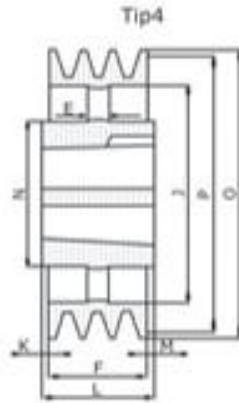
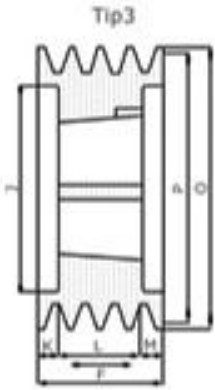

Kod (Code)	Kanal (Grooves)	P	O	Type (Type)	Burç (Bush)	Maks. Delik (Max. Bore)	E	F	J	K	L	M	N
SPC 200-04	4	200	209.6	3	3020	75	-	111	144	30	51	30	-
SPC 212-04	4	212	221.6	3	3020	75	-	111	156	30	51	30	-
SPC 224-04	4	224	233.6	3	3535	90	-	111	168	11	89	11	-
SPC 236-04	4	236	245.6	3	3535	90	-	111	180	11	89	11	-
SPC 250-04	4	250	259.6	3	3535	90	-	111	194	11	89	11	-
SPC 265-04	4	265	274.6	3	3535	90	-	111	209	11	89	11	-
SPC 280-04	4	280	289.6	3	3535	90	-	111	224	11	89	11	-
SPC 300-04	4	300	309.6	6	3535	90	20	111	244	11	89	11	170
SPC 315-04	4	315	324.6	6	3535	90	20	111	259	11	89	11	170
SPC 335-04	4	335	344.6	6	3535	90	20	111	279	11	89	11	170
SPC 355-04	4	355	364.6	6	3535	90	20	111	299	11	89	11	170
SPC 375-04	4	375	384.6	6	3535	90	25	111	319	11	89	11	170
SPC 400-04	4	400	409.6	5	3535	90	-	111	344	11	89	11	170
SPC 425-04	4	425	434.6	5	3535	90	-	111	369	11	89	11	170
SPC 450-04	4	450	459.6	5	3535	90	-	111	394	11	89	11	170
SPC 475-04	4	475	484.6	5	3535	90	-	111	419	11	89	11	170
SPC 500-04	4	500	509.6	5	3535	90	-	111	444	11	89	11	170
SPC 530-04	4	530	539.6	5	4040	100	-	111	474	4.5	102	4.5	170
SPC 560-04	4	560	569.6	5	4040	100	-	111	504	4.5	102	4.5	200
SPC 630-04	4	630	639.6	4	4545	110	-	111	574	1.5	114	1.5	225
SPC 710-04	4	710	719.6	4	5050	125	-	111	654	4	127	12	245
SPC 800-04	4	800	809.6	4	5050	125	-	111	737	4	127	12	245
SPC 1000-04	4	1000	1009.6	4	5050	125	-	111	937	4	127	12	245
SPC 1250-04	4	1250	1259.6	4	5050	125	-	111	1187.6	4	127	12	245

Burçlu V Kayış Kasnakları

V Pulley With Taper Bush



SPC / 5

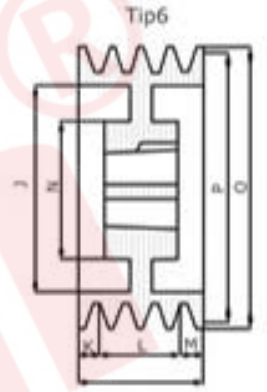
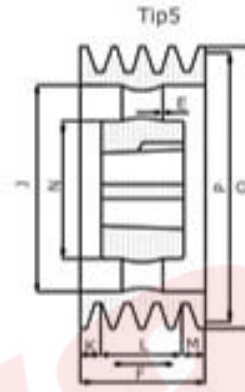
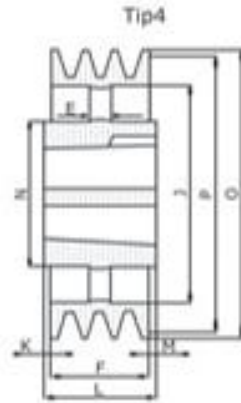
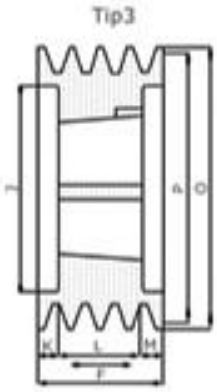

Kod (Code)	Kanal (Grooves)	P	O	Type (Type)	Burç (Bush)	Maks. Delik (Max. Bore)	E	F	J	K	L	M	N
SPC 200-05	5	200	209.6	3	3535	90	-	136	150	23.5	89	23.5	-
SPC 212-05	5	212	221.6	3	3535	90	-	136	160	23.5	89	23.5	-
SPC 224-05	5	224	233.6	3	3535	90	-	136	173	23.5	89	23.5	-
SPC 236-05	5	236	245.6	3	3535	90	-	136	185	23.5	89	23.5	-
SPC 250-05	5	250	259.6	3	3535	90	-	136	198	23.5	89	23.5	-
SPC 265-05	5	265	274.6	3	3535	90	-	136	213	23.5	89	23.5	-
SPC 280-05	5	280	289.6	3	3535	90	-	136	228	23.5	89	23.5	-
SPC 300-05	5	300	309.6	6	3535	90	20	136	247	23.5	89	23.5	170
SPC 315-05	5	315	324.6	6	3535	90	20	136	264	23.5	89	23.5	170
SPC 335-05	5	335	344.6	6	3535	90	20	136	280	23.5	89	23.5	170
SPC 355-05	5	355	364.6	6	3535	90	20	136	304	23.5	89	23.5	170
SPC 375-05	5	375	384.6	6	3535	90	20	136	324	23.5	89	23.5	170
SPC 400-05	5	400	409.6	5	3535	90	-	136	344	23.5	89	23.5	170
SPC 425-05	5	425	434.6	5	3535	90	-	136	369	23.5	89	23.5	170
SPC 450-05	5	450	459.6	5	4040	100	-	136	394	17	102	17	200
SPC 475-05	5	475	484.6	5	4040	100	-	136	419	17	102	17	200
SPC 500-05	5	500	509.6	5	4040	100	-	136	444	17	102	17	200
SPC 530-05	5	530	539.6	5	4545	100	-	136	474	17	102	17	200
SPC 560-05	5	560	569.6	5	4545	100	-	136	504	11	114	11	200
SPC 630-05	5	630	639.6	5	5050	125	-	136	574	4.5	127	4.5	245
SPC 710-05	5	710	719.6	5	5050	125	-	136	654	4.5	127	4.5	245
SPC 800-05	5	800	809.6	5	5050	125	-	136	737	4.5	127	4.5	245
SPC 1000-05	5	1000	1009.6	5	5050	125	-	136	937	4.5	127	4.5	245
SPC 1250-05	5	1250	1259.6	5	5050	125	-	136	1187	4.5	127	4.5	245

Burçlu V Kayış Kasnakları

V Pulley With Taper Bush



SPC / 6

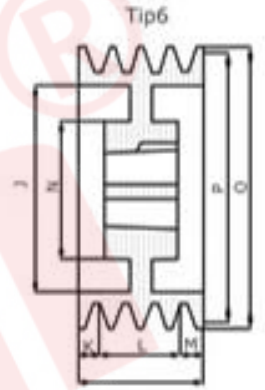
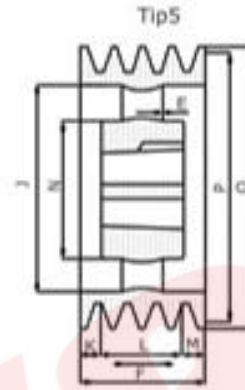
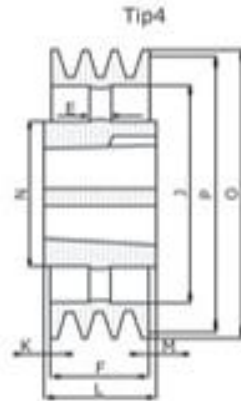
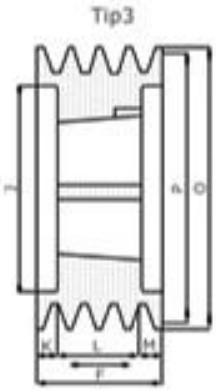

Kod (Code)	Kanal (Grooves)	P	O	Type (Type)	Burç (Bush)	Maks. Delik (Max. Bore)	E	F	J	K	L	M	N
SPC 200-06	6	200	209.6	3	3535	90	-	162	148	36.5	89	36.5	-
SPC 212-06	6	212	221.6	3	3535	90	-	162	160	36.5	89	36.5	-
SPC 224-06	6	224	233.6	3	3535	90	-	162	173	36.5	89	36.5	-
SPC 236-06	6	236	245.6	3	3535	90	-	162	185	36.5	89	36.5	-
SPC 250-06	6	250	259.6	3	3535	90	-	162	198	36.5	89	36.5	-
SPC 265-06	6	265	274.6	3	3535	90	-	162	213	36.5	89	36.5	-
SPC 280-06	6	280	289.6	3	3535	90	-	162	228	36.5	89	36.5	-
SPC 300-06	6	300	309.6	6	3535	90	20	162	247	36.5	89	36.5	170
SPC 315-06	6	315	324.6	6	3535	90	20	162	264	36.5	89	36.5	170
SPC 335-06	6	335	344.6	6	3535	90	20	162	280	36.5	89	36.5	170
SPC 355-06	6	355	364.6	6	3535	90	20	162	304	36.5	89	36.5	170
SPC 375-06	6	375	384.6	6	4040	100	20	162	324	30	102	30	200
SPC 400-06	6	400	409.6	6	4040	100	20	162	348	30	102	30	200
SPC 425-06	6	425	434.6	6	4040	100	30	162	369	30	102	30	225
SPC 450-06	6	450	459.6	6	4545	110	30	162	394	24	114	24	225
SPC 475-06	6	475	484.6	6	4545	110	30	162	419	24	114	24	225
SPC 500-06	6	500	509.6	5	4545	110	30	162	444	24	114	24	225
SPC 530-06	6	530	539.6	5	5050	125	30	162	474	17.5	114	17.5	245
SPC 560-06	6	560	569.6	5	5050	125	-	162	504	24	127	24	245
SPC 630-06	6	630	639.6	5	5050	125	-	162	574	17.5	127	17.5	245
SPC 710-06	6	710	719.6	5	5050	125	-	162	654	17.5	127	17.5	245
SPC 800-06	6	800	809.6	5	5050	125	-	162	737	17.5	127	17.5	245
SPC 1000-06	6	1000	1009.6	5	5050	125	-	162	937	17.5	127	17.5	245
SPC 1250-06	6	1250	1259.6	5	5050	125	-	162	1187	17.5	127	17.5	245

Burçlu V Kayış Kasnakları

V Pulley With Taper Bush



SPC / 8

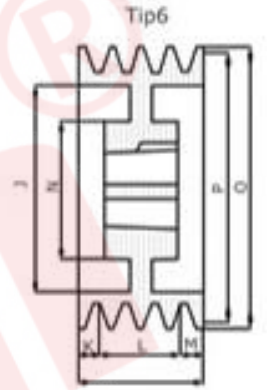
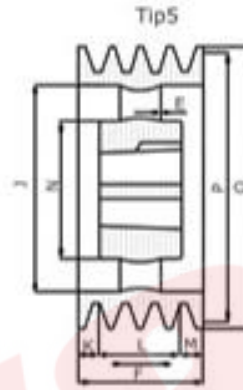
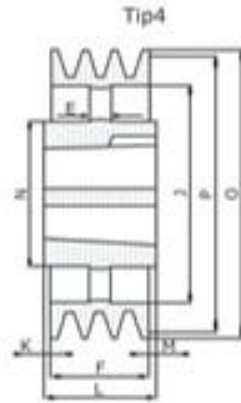
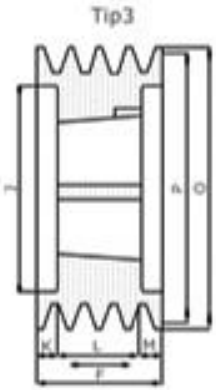

Kod (Code)	Kanal (Grooves)	P	O	Type (Type)	Burç (Bush)	Maks. Delik (Max. Bore)	E	F	J	K	L	M	N
SPC 200-08	8	200	209.6	3	3535	90	-	213	148	62	89	62	-
SPC 212-08	8	212	221.6	3	3535	90	-	213	160	62	89	62	-
SPC 224-08	8	224	233.6	3	3535	90	-	213	170	62	89	62	-
SPC 236-08	8	236	245.6	3	3535	90	-	213	184	62	89	62	-
SPC 250-08	8	250	259.6	3	3535	90	-	213	198	62	89	62	-
SPC 265-08	8	265	274.6	3	3535	90	-	213	213	62	89	62	-
SPC 280-08	8	280	289.6	3	3535	90	-	213	228	62	89	62	-
SPC 300-08	8	300	309.6	3	4040	100	-	213	247	55.5	102	55.5	-
SPC 315-08	8	315	324.6	3	4040	100	-	213	258	55.5	102	55.5	-
SPC 335-08	8	335	344.6	6	4040	100	-	213	280	55.5	102	55.5	-
SPC 355-08	8	355	364.6	3	4040	100	-	213	304	55.5	102	55.5	-
SPC 375-08	8	375	384.6	3	4545	110	-	213	324	49.5	114	49.5	-
SPC 400-08	8	400	409.6	6	4545	110	20	213	348	49.5	114	49.5	220
SPC 425-08	8	425	434.6	6	4545	110	30	213	369	49.5	114	49.5	245
SPC 450-08	8	450	459.6	6	5050	125	30	213	394	43	127	127	245
SPC 475-08	8	475	484.6	6	5050	125	30	213	419	43	127	127	245
SPC 500-08	8	500	509.6	6	5050	125	30	213	444	43	127	127	245
SPC 530-08	8	530	539.6	6	5050	125	30	213	474	43	127	127	245
SPC 560-08	8	560	569.6	5	5050	125	-	213	504	43	127	127	245
SPC 630-08	8	630	639.6	5	5050	125	-	213	574	43	127	127	245
SPC 710-08	8	710	719.6	5	5050	125	-	213	656	43	127	127	245
SPC 800-08	8	800	809.6	5	5050	125	-	213	737	43	127	127	245
SPC 1000-08	8	1000	1009.6	5	5050	125	-	213	937	43	127	127	245
SPC 1250-08	8	1250	1259.6	5	5050	125	-	213	1187	43	127	127	245

Burçlu V Kayış Kasnakları

V Pulley With Taper Bush



SPC / 10

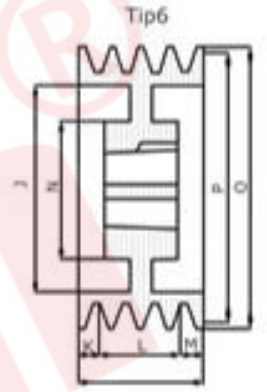
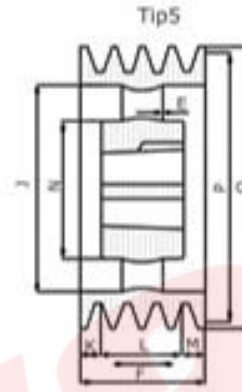
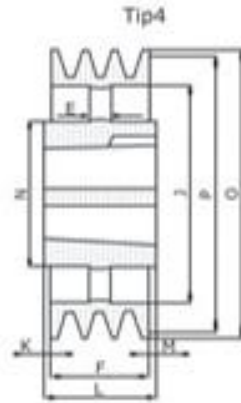
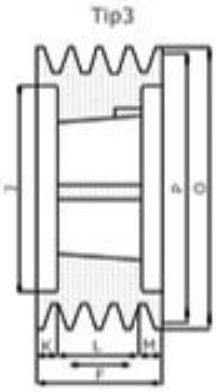

Kod (Code)	Kanal (Grooves)	P	O	Type (Type)	Burç (Bush)	Maks. Delik (Max. Bore)	E	F	J	K	L	M	N
SPC 250-10	10	250	259.6	3	4040	100	-	264	196	81	102	81	-
SPC 280-10	10	280	289.6	3	4040	100	-	264	226	81	102	81	-
SPC 300-10	10	300	309.6	3	4545	110	-	264	245	75	114	75	-
SPC 315-10	10	315	324.6	3	4545	110	-	264	258	75	114	75	-
SPC 355-10	10	355	364.6	3	4545	110	-	264	299	75	114	75	-
SPC 400-10	10	400	409.6	3	5050	125	-	264	342	68.5	127	68.5	245
SPC 450-10	10	450	459.6	6	5050	125	40	264	394	68.5	127	68.5	245
SPC 500-10	10	500	509.6	6	5050	125	40	264	444	68.5	127	68.5	245
SPC 560-10	10	560	569.6	5	5050	125	-	264	504	68.5	127	68.5	245
SPC 630-10	10	630	639.6	5	5050	125	-	264	574	68.5	127	68.5	245
SPC 710-10	10	710	719.6	5	5050	125	-	264	654	68.5	127	68.5	245
SPC 800-10	10	800	809.6	5	5050	125	-	264	737	68.5	127	68.5	245
SPC 1000-10	10	1000	1009.6	5	5050	125	-	264	937	68.5	127	68.5	245
SPC 1250-10	10	1250	1259.6	5	5050	125	-	264	1187	68.5	127	68.5	245



BURÇLU POLY-V KAYIŞ KASNAKLARI

POLY-V PULLEYS WITH TAPER BUSH



* Motor Gücü ve Devir sayısına Göre Poly-V Kasnak Seçimi

* Poly-V Kasnak Kanal Profil Ölçüleri

* Siparişte Kullanılan Kodlama Yöntemi

* Choosing of The Poly-V Pulleys According to The Motor Power and Rpm

* Profile Dimensions of The Poly-V Grooves

* Nomenclature for The Order

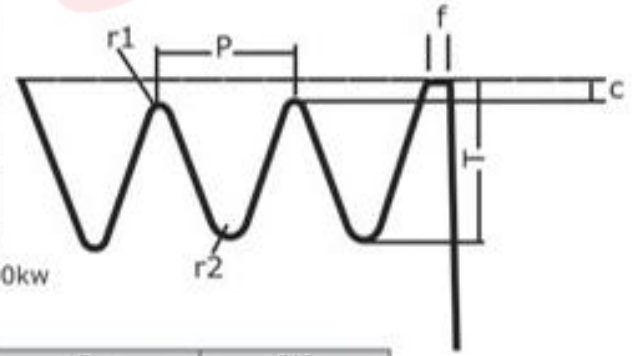
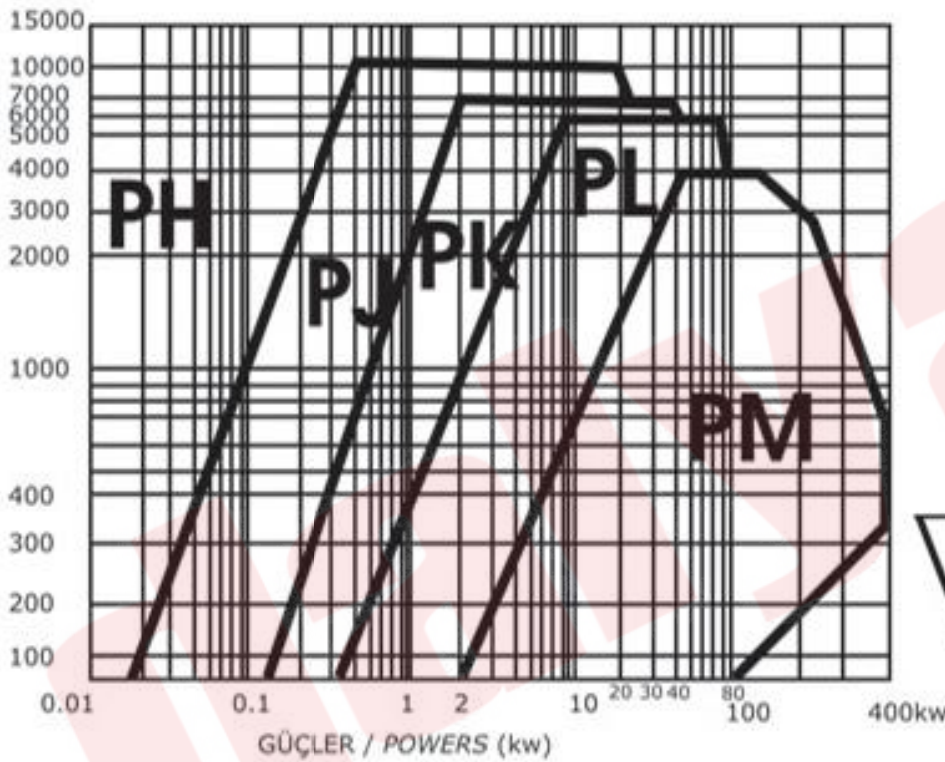

	PH	PJ	PK	PL	PM
p	1,60	2,34	3,56	4,70	9,40
r1 min	0,15	0,24	0,25	0,40	0,75
r2 max	0,30	0,40	0,50	0,40	0,75
f	1,30	1,80	2,50	3,30	6,40
T	1,50	2,21	3,75	5,11	10,21
MinØ	18	20	40	75	180
c	0,80	1,20	1,50	3,00	4,00
kanal n (Grooves)	6,8,12,16	6,8,12,16,20	8,12,16,20	6,8,12,16,20	6,10,16,20

● KODLAMADA KULLANILAN DEĞİŞKENLER / USE VARIABLES FOR CODE

- Anma Çapı / Diameter
- Kanal Sayısı / Groove
- Kayış Tipi / Belt Type
- Mil Çapı / Mile Diameter

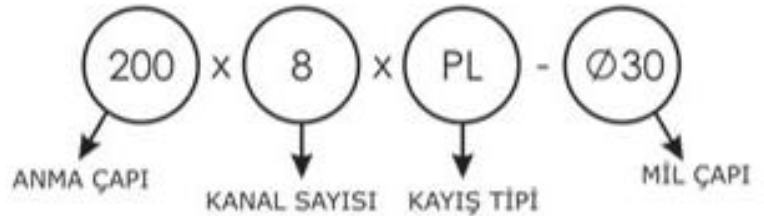

Burçlu Poly-V Kayış Kasnakları

Poly-V Pulleys With Taper Bush



Pj Profilli Burçlu Poly-V Kasnaklar / Pj Poly-V Pulleys

Tip / Type 1

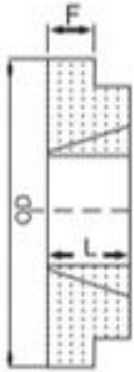

Tip / Type 2

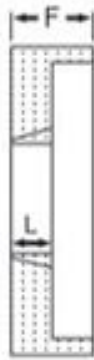

Tip / Type 3



Tip / Type 4

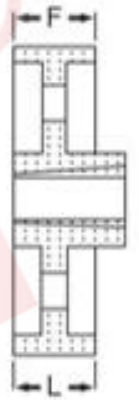

PJ4

Çap (Diameter)	Tip (Type)	Burç no (Bush no)	F	L
55	1	1008	14	22
60	1	1008	14	22
70	1	1108	14	22
80	1	1108	14	22
90	1	1108	14	22
100	1	1210	14	25
110	1	1210	14	25
125	1	1610	14	25
140	1	1610	14	25
150	1	1610	14	25
160	1	1610	14	25
170	3	1610	14	25
180	3	1610	14	25
190	3	1610	14	25
200	3	1610	14	25
210	3	1610	14	25
220	3	1610	14	25
250	3	2012	14	31
300	4	2012	14	31
400	4	2517	14	45
500	4	2517	14	45

PJ8

Çap (Diameter)	Tip (Type)	Burç no (Bush no)	F	L
55	2	1008	24	22
60	2	1008	24	22
70	2	1108	24	22
80	2	1108	24	22
90	1	1210	24	25
100	1	1210	24	25
110	1	1610	24	25
125	1	1610	24	25
140	1	1610	24	25
150	1	1610	24	25
160	1	1610	24	25
170	3	1610	24	25
180	3	1610	24	25
190	3	1610	24	25
200	3	2012	24	31
210	3	2012	24	31
220	3	2012	24	31
250	3	2012	24	31
300	4	2012	24	31
400	4	2517	24	45
500	4	2517	24	45

BURÇLU POLY-V KAYIŞ KASNAKLARI

POLY-V PULLEYS WITH TAPER BUSH



PJ Profilli Burçlu Poly-V Kasnaklar / Pj Poly-V Pulleys

Tip / Type 1

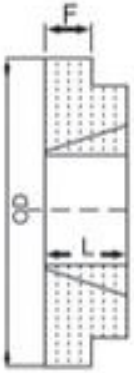

Tip / Type 2



Tip / Type 3

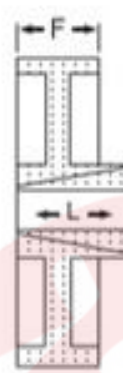

Tip / Type 4

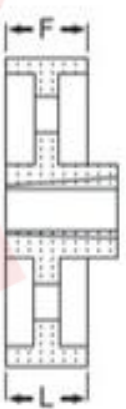

PJ12

Çap	Tip	Burç no	F	L
70	2	1108	33	22
80	2	1210	33	22
90	2	1610	33	22
100	2	1610	33	25
110	2	1610	33	25
125	2	1610	33	25
140	2	1610	33	25
150	2	1610	33	25
160	2	1610	33	25
170	2	1610	33	25
180	5	1610	33	25
190	5	1610	33	25
200	5	2012	33	31
210	5	2012	33	31
220	5	2012	33	31
250	5	2012	33	31
300	6	2012	33	31
400	4	2517	33	45
500	4	2517	33	45

PJ16

Çap	Tip	Burç no	F	L
80	2	1210	43	22
90	2	1610	43	25
100	2	1610	43	25
110	2	1610	43	25
125	2	2012	43	31
140	2	2012	43	31
150	2	2012	43	31
160	2	2012	43	31
170	2	2012	43	31
180	5	2012	43	31
190	5	2012	43	31
200	5	2012	43	31
210	5	2012	43	31
220	5	2012	43	31
250	5	2012	43	31
300	5	2012	43	31
400	6	2517	43	45
500	4	2517	43	45

Burçlu Poly-V Kayış Kasnakları

Poly-V Pulleys With Taper Bush



PK Profilli Burçlu Poly-V Kasnaklar / PK Poly-V Pulleys

Tip / Type 1

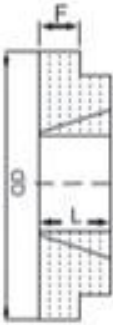

Tip / Type 2



Tip / Type 3

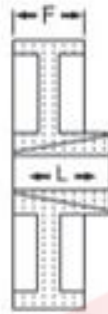

Tip / Type 4



Tip / Type 5



PK4

Çap (Diameter)	Tip (Type)	Burç No (Bush No)	F	L
60	1	1108	22	22
70	1	1108	22	22
80	1	1108	22	22
90	1	1108	22	22
100	1	1210	22	25
110	1	1610	22	25
125	1	1610	22	25
140	1	1610	22	25
150	1	1610	22	25
160	1	1610	22	25
170	1	1610	22	25
180	3	1610	22	25
190	3	1610	22	25
200	3	1610	22	25
210	3	1610	22	25
220	3	1610	22	25
250	3	2012	22	31
300	4	2012	22	31
400	4	2517	22	45
500	4	3020	22	51

PK8

Çap (Diameter)	Tip (Type)	Burç No (Bush No)	F	L
60	2	1108	36	22
70	2	1108	36	22
80	2	1108	36	22
90	2	1210	36	25
100	2	1610	36	25
110	2	1610	36	25
125	2	1610	36	25
140	2	1610	36	25
150	2	1610	36	25
160	2	1610	36	25
170	2	1610	36	25
180	5	1610	36	25
190	5	1610	36	25
200	5	2012	36	31
210	5	2012	36	31
220	5	2012	36	31
250	5	2012	36	31
300	4	2517	36	45
400	4	3020	36	45
500	4	3020	36	51

BURÇLU POLY-V KAYIŞ KASNAKLARI

POLY-V PULLEYS WITH TAPER BUSH



PK Profilli Burçlu Poly-V Kasnaklar / PK Poly-V Pulleys

Tip / Type 2



Tip / Type 4



Tip / Type 5



Tip / Type 6



PK12

PK16

Çap (Diameter)	Tip (Type)	Burç No (Bushes No)	F	L
70	2	1108	50	22
80	2	1210	50	22
90	2	1610	50	22
100	2	1610	50	25
110	2	1610	50	25
125	2	1610	50	25
140	2	1610	50	25
150	2	1610	50	25
160	5	1610	50	25
170	5	1610	50	25
180	5	1610	50	25
190	5	1610	50	25
200	5	2012	50	31
210	5	2012	50	31
220	5	2012	50	31
250	5	2517	50	45
300	6	2517	50	45
400	4	3020	50	51
500	4	3535	50	90

Çap	Tip	Burç no	F	L
70	2	1108	50	22
80	2	1210	50	22
90	2	1610	50	22
100	2	1610	50	25
110	2	1610	50	25
125	2	1610	50	25
140	2	1610	50	25
150	2	1610	50	25
160	5	1610	50	25
170	5	1610	50	25
180	5	1610	50	25
190	5	1610	50	25
200	5	2012	50	31
210	5	2012	50	31
220	5	2012	50	31
250	5	2517	50	45
300	6	2517	50	45
400	4	3020	50	51
500	4	3535	50	90

Burçlu Poly-V Kayış Kasnakları

Poly-V Pulleys With Taper Bush



PL Profilli Burçlu Poly-V Kasnaklar / PL Poly-V Pulleys

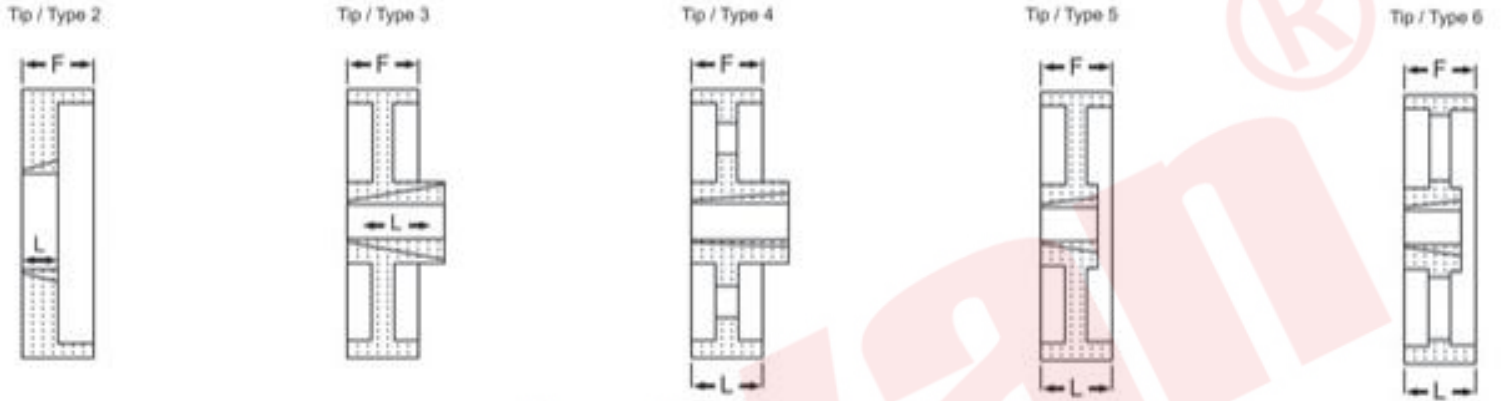

PL4

Çap (Diameter)	Tip (Type)	Burç No (Bush No)	F	L
60	1	1008	29	22
70	1	1108	29	22
80	1	1108	29	22
90	1	1108	29	22
100	1	1610	29	25
110	1	1610	29	25
125	1	1610	29	25
140	1	1610	29	25
150	1	1610	29	25
160	1	1610	29	25
170	3	1610	29	25
180	3	2012	29	31
190	3	2012	29	31
200	3	2012	29	31
210	3	2012	29	31
220	3	2012	29	31
250	3	2012	29	31
300	4	2012	29	31
400	4	2517	29	45
500	4	3020	29	51

PL8

Çap (Diameter)	Tip (Type)	Burç No (Bushes No)	F	L
80	2	1108	48	22
90	2	1610	48	25
100	2	1610	48	25
110	2	1610	48	25
125	2	2012	48	31
140	2	2012	48	31
150	2	2012	48	31
160	2	2012	48	31
170	2	2012	48	31
180	2	2012	48	31
190	5	2012	48	31
200	5	2012	48	31
210	3	2012	48	31
220	3	2012	48	31
250	3	2012	48	31
300	6	2012	48	45
400	4	2517	48	51
500	4	3020	48	51

BURÇLU POLY-V KAYIŞ KASNAKLARI

POLY-V PULLEYS WITH TAPER BUSH



PL Profilli Burçlu Poly-V Kasnaklar / PL Poly-V Pulleys

Tip / Type 2



Tip / Type 3

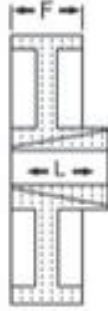

Tip / Type 4



Tip / Type 5



Tip / Type 6

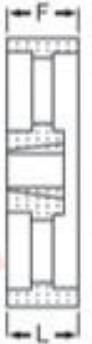

PL12

Çap (Diameter)	Tip (Type)	Burç No (Bushes No)	F	L
100	2	1610	66	25
110	2	1610	66	25
125	2	2012	66	31
140	2	2012	66	31
150	2	2517	66	45
160	2	2517	66	45
170	2	2517	66	45
180	2	2517	66	45
190	2	2517	66	45
200	5	2517	66	45
210	5	2517	66	45
220	5	2517	66	45
250	5	2517	66	45
300	6	2517	66	45
400	6	3020	66	51
500	4	3535	66	90

PL16

Çap (Diameter)	Tip (Type)	Burç No (Bushes No)	F	L
110	2	1615	85	35
125	2	2517	85	45
140	2	2217	85	45
150	2	3020	85	51
160	2	3020	85	51
170	2	3020	85	51
180	2	3020	85	51
190	2	3020	85	51
200	2	3020	85	51
210	5	3020	85	51
220	5	3020	85	51
250	5	3020	85	51
300	3	3535	85	90
400	4	3535	85	90
500	4	3535	85	90

Burçlu Poly-V Kayış Kasnakları

Poly-V Pulleys With Taper Bush



PM Profilli Burçlu Poly-V Kasnaklar / PM Poly-V Pulleys

Tip / Type 2



Tip / Type 4

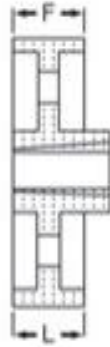

Tip / Type 5

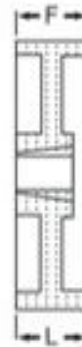

Tip / Type 6



PM8

Çap (Diameter)	Tip (Type)	Burç no (Bush No)	F	L
170	2	2717	94	46
180	2	2517	94	46
190	2	2517	94	46
200	2	3020	94	51
210	2	3020	94	51
220	2	3020	94	51
230	5	3020	94	51
250	5	3020	94	51
280	5	3535	94	89
315	5	3535	94	89
355	5	3535	94	89
400	6	3535	94	89
500	4	4040	94	100
630	4	5050	94	125
800	4	5050	94	125

PM12

Çap (Diameter)	Tip (Type)	Burç no (Bush No)	F	L
170	2	3020	132	51
180	2	3020	132	51
190	2	3020	132	51
200	2	3020	132	51
210	2	3020	132	51
220	2	3020	132	51
230	5	3020	132	51
250	5	3535	132	89
280	5	3535	132	89
315	5	3535	132	89
355	5	3535	132	89
400	6	3535	132	89
500	6	4040	132	100
630	6	5050	132	125
800	6	5050	132	125

PM16

Çap (Diameter)	Tip (Type)	Burç no (Bush No)	F	L
170	2	3020	170	51
180	2	3020	170	51
190	2	3020	170	51
200	2	3020	170	76
210	2	3020	170	76
220	2	3020	170	76
230	5	3020	170	76
250	5	3535	170	89
280	5	3535	170	89
315	5	3535	170	89
355	5	3535	170	100
400	6	3535	170	100
500	6	3535	170	125
630	6	5050	170	125
800	6	5050	170	125

PM20

Çap (Diameter)	Tip (Type)	Burç no (Bush No)	F	L
170	2	3020	207	51
180	2	3020	207	51
190	2	3030	207	76
200	2	3030	207	76
210	2	3030	207	76
220	2	3030	207	76
230	5	3030	207	76
250	5	3535	207	89
280	5	3535	207	89
315	5	3535	207	89
355	5	4040	207	100
400	6	4040	207	100
500	6	4545	207	115
630	6	5050	207	125
800	6	5050	207	125

**KAPLİNER
COUPLINGS**



Kaplinler Couplings



Yıldız Kaplin ve Siparişte Kullanılan Kodlama Yöntemi
(The codification method that is used in orders)

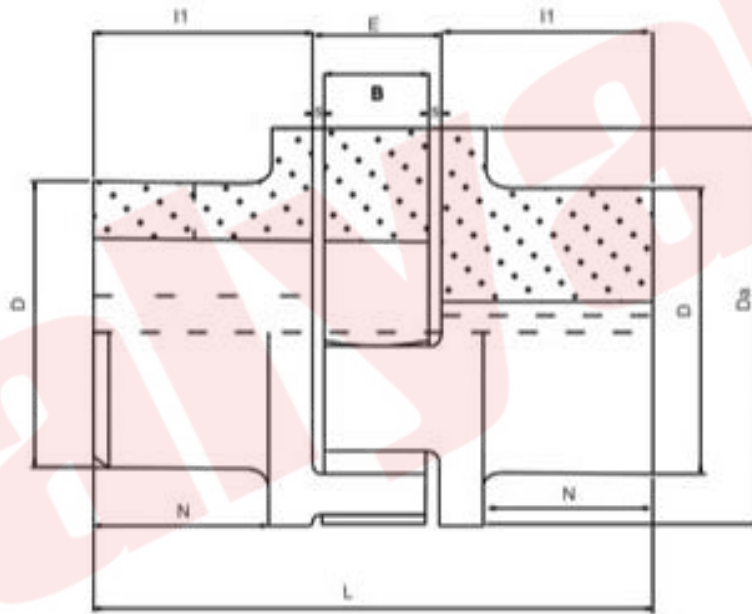
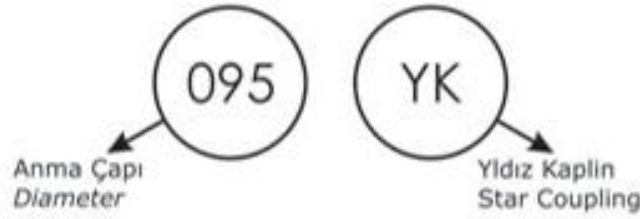

Kaplin (coupling)	Ölçüler / Metres (mm)										Ağırlık (Weight)
	Da	D1	E	S	B	L	N	I11	Dmin	Dmax	
Y 065	65	48	22	2,5	17	76	18	27	12	12	1,100
Y 080	80	60	26	3	20	120	37	47	14	14	2,550
Y 095	95	75	28	3	22	122	37	47	14	14	3,100
Y 110	110	85	31	2	27	141	42	55	15	15	5,900
Y 125	125	100	35	2	31	163	52	64	15	15	9,000
Y 140	140	102	41	3	35	177	56	68	15	15	10,400
Y 160	160	122	50	3	44	202	63	76	17	17	17,000
Y 180	180	126	53	4	45	217	67	82	20	20	21,000
Y 200	200	136	55	5	45	245	77	95	20	20	28,100
Y 225	225	145	53	4	45	269	85	108	20	20	38,100
Y 250	250	160	51	3	45	279	89	114	20	20	48,000

Kaplinler Couplings



Elastik Dişli Kaplin
(Coupling)

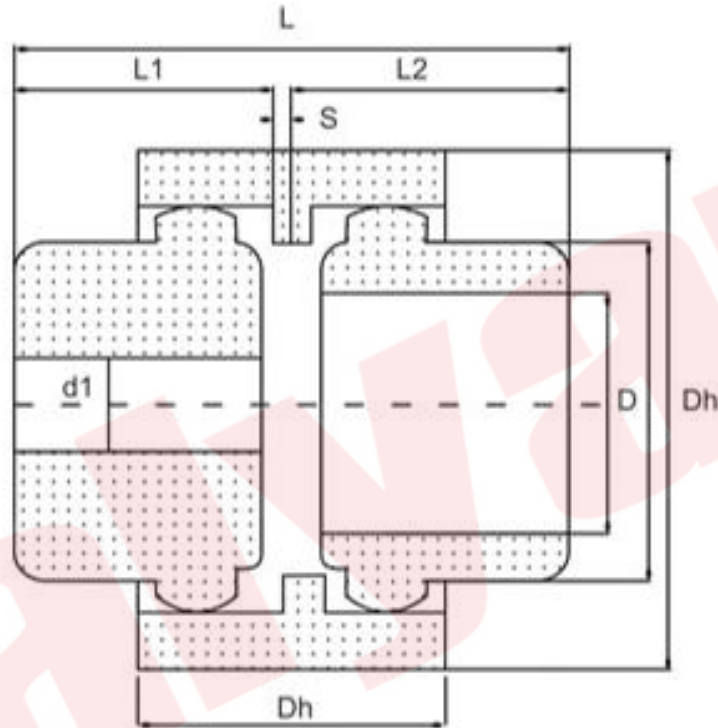

Kaplin (Coupling)	Ölçüler / Metres (mm)								Max.Devir (Max.Revolucation) (dev/dk)	Max.Moment (kp-m)	Ağırlık (Weight) (Kg)
	d1	d2	L1=L2	L	L _H	D	D _H	S			
DK 14	6	14	23	50	30	25	40	4	6000	1.0-1.5	0.045
DK 24	11	24	26	56	37	36	54	4	6000	2.0-3.0	0.450
DK 28	13	28	40	84	39	44	66	4	6000	3.6-5.4	1.035
DK 32	13	32	40	84	48	50	76	4	6000	5.0-7.5	1.340
DK 38	14	38	40	84	48	58	83	4	6000	6.4-9.6	1.765
DK 42	14	42	42	88	50	60	88	4	5000	8.0-12.0	2.025
DK 48	14	48	50	104	50	68	100	4	5000	12.0-18.0	3.030
DK 55	18	55	60	124	64	83	122	4	4000	25.0-40.0	5.520
DK 60	18	60	70	144	72	92	140	4	3600	30.0-45.0	8.160

Kaplinler Couplings



Ayaklı Kaplin
(Coupling)

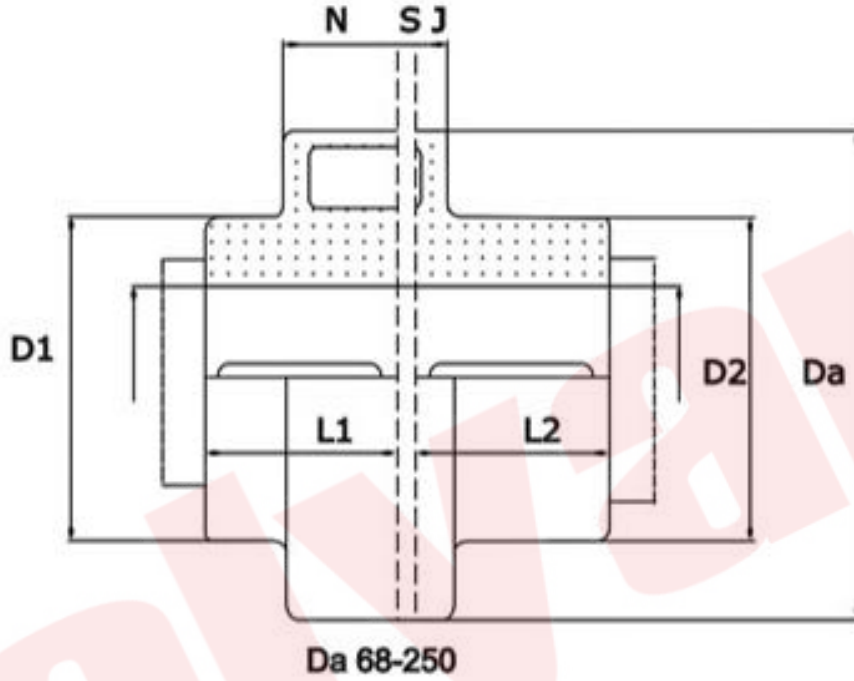

Kaplin (Coupling)	Ölçüler / Metres (mm)										Ağırlık (Weight) (Kg)
	Da	D1	D2	L1	L2	J	N	S	D min	D max	
B 068	68	45	45	37	38	8	22	2-4	14	24	1.100
B 080	80	49	50	43	44	8	23	2-4	14	30	1.600
B 095	95	59	60	50	50	9	26	2-4	18	42	2.600
B 110	110	70	70	54	55	10	28	2-4	18	48	4.000
B 125	125	80	83	58	58	11	30	2-4	20	55	5.500
B 140	140	95	95	62	58	12	34	2-4	22	60	7.650
B 160	160	108	108	68	64	13	39	2-6	22	65	11.000
B 180	180	125	114	74	76	16	42	2-6	22	75	15.800
B 200	200	134	125	84	82	17	47	2-6	22	85	20.800
B 225	225	143	130	92	92	18	52	2-6	22	90	27.500
B 250	250	165	145	102	102	21	60	3-8	22	100	37.800

KÖR KASNAKLAR VE ÖZEL ÜRETİMLER

V PULLEYS AND SPECIAL PRODUCTIONS

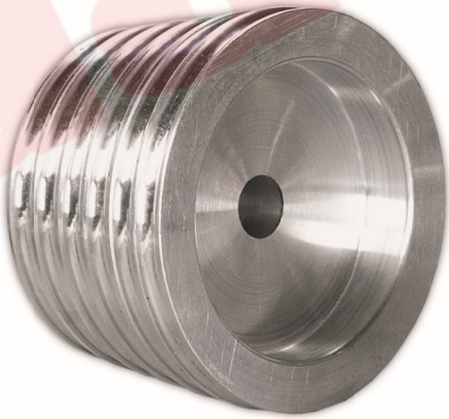
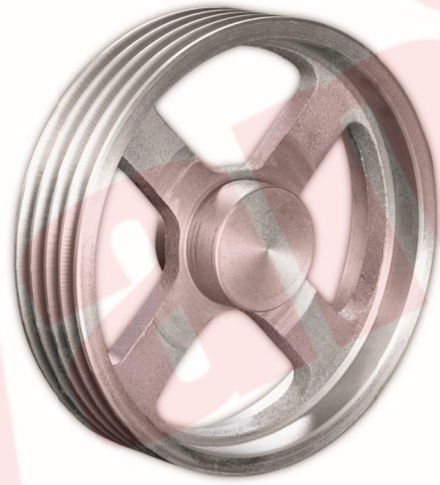

Kör Kasnaklar ve Özel Üretimler

V Pulleys And Special Productions



Mevcut Modeller
(Available Models)

Çap (mm) (Diameter)	Kanal sayısı / Grooves Numbe		
	13 (SPA)	17 (SPB)	22 (SPC)
275	1-2-3-4-5-6	1-2-3-4-5-6	1-2-3-4-5
280	-	-	1-2-3-4-5-6-8
290	-	-	1-2-3-4-5-6-8
300	1-2-3-4-5-6	1-2-3-4-5-6	1-2-3-4-5-6-8
310	-	-	1-2-3-4-5
325	1-2-3-4-5-6	1-2-3-4-5-6	1-2-3-4-5-6-8
330	-	-	1-2-3-4-5
340	-	-	1-2-3-4-5
350	1-2-3-4-5-6	1-2-3-4-5-6	1-2-3-4-5-6-8-12
360	-	-	1-2-3-4-5
375	1-2-3-4-5-6	1-2-3-4-5-6	1-2-3-4-5-6-8
380	-	-	1-2-3-4-5
400	1-2-3-4-5-6	1-2-3-4-5-6	1-2-3-4-5-6-8-12
425	1-2-3-4-5-6	1-2-3-4-5-6	1-2-3-4-5
450	1-2-3-4-5-6	1-2-3-4-5-6	2-3-4-5-6-8-12
500	1-2-3-4-5-6	1-2-3-4-5-6	2-3-4-5-6-8-12
550	1-2-3-4-5-6	1-2-3-4-5-6	2-3-4-5-6-8-12
600	1-2-3-4-5-6	1-2-3-4-5-6	2-3-4-5-6-8-12
650	2-3-4-5-6	2-3-4-5-6	3-4-5-8-12
700	2-3-4-5-6	2-3-4-5-6	3-4-5
750	-	-	3-4-5
800	3-4-5-6	3-4-5-6	3-4-5-8
900	4-5-6	4-5-6	4-5
950	5-6	5-6	4-5
970	-	4-5-6-7-8	4-5-6-7

Çap (mm) (Diameter)	Kanal Sayısı / Grooves Number		
	13 (SPA)	17 (SPB)	22 (SPC)
50	1-2	1-2	-
60	1-2	1-2	-
75	1-2-3	1-2-3	-
80	1-2-3-4	1-2-3-4	-
90	1-2-3-4-5-6	1-2-3-4-5-6	-
100	1-2-3-4-5-6	1-2-3-4-5-6	1-2-3-4-5
110	1-2-3-4-5-6	1-2-3-4-5-6	1-2-3-4-5
125	1-2-3-4-5-6	1-2-3-4-5-6	1-2-3-4-5
130	1-2-3-4-5-6	1-2-3-4-5-6	-
140	1-2-3-4-5-6	1-2-3-4-5-6	1-2-3-4-5
150	1-2-3-4-5-6	1-2-3-4-5-6	1-2-3-4-5-6-8
160	1-2-3-4-5-6	1-2-3-4-5-6	1-2-3-4-5
170	-	-	6-8
175	1-2-3-4-5-6	1-2-3-4-5-6	1-2-3-4-5
180	1-2-3-4-5-6	1-2-3-4-5-6	1-2-3-4-5-6-8
190	1-2-3-4-5-6	1-2-3-4-5-6	1-2-3-4-5-6-8
200	1-2-3-4-5-6	1-2-3-4-5-6	1-2-3-4-5-6-8
210	-	-	1-2-3-4-5-6-8
220	-	-	1-2-3-4-5-6-8
225	1-2-3-4-5-6	1-2-3-4-5-6	1-2-3-4-5
230	-	-	1-2-3-4-5-6-8
240	1-2-3-4-5-6	1-2-3-4-5-6	1-2-3-4-5-6-8
250	1-2-3-4-5-6	1-2-3-4-5-6	1-2-3-4-5-6-8
260	1-2-3-4-5-6	1-2-3-4-5-6	1-2-3-4-5-6-8
270	-	-	6-8

Not : Sipariş Halinde Ara Çaplardaki Özel Kasnaklarda Yapılabilir.
(special belts in the inter-diameters can be also made in case of an order)

KÖR KASNAKLAR VE ÖZEL ÜRETİMLER

V PULLEYS AND SPECIAL PRODUCTIONS



Not : Otomotiv ve Tekstil Sanayi Gibi Hassaslık İsteyen Standart Dışı Kasnaklar da Üretilmektedir.
(*Out-of-standard belts which require sensitivity like automotive and textile industry can be also produced.*)