



**DIY Elta Tools**



DV dahil değildir.

**www.eltaaletleri.com.tr**



**Bir tık mesafesi kadar yakın...**

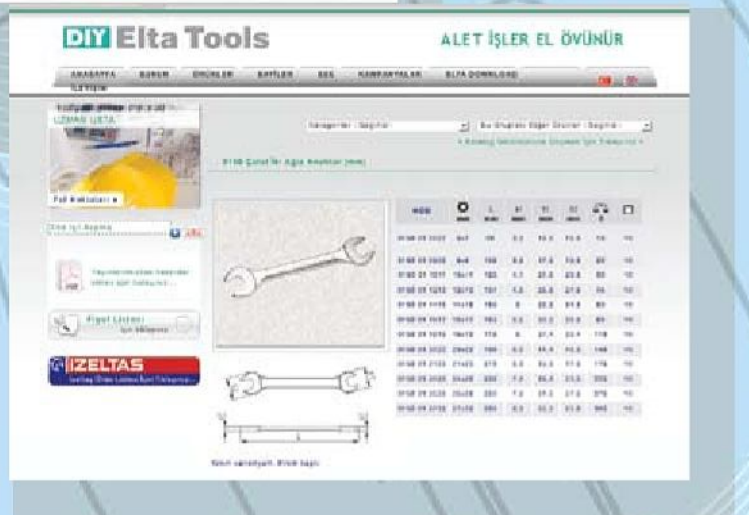
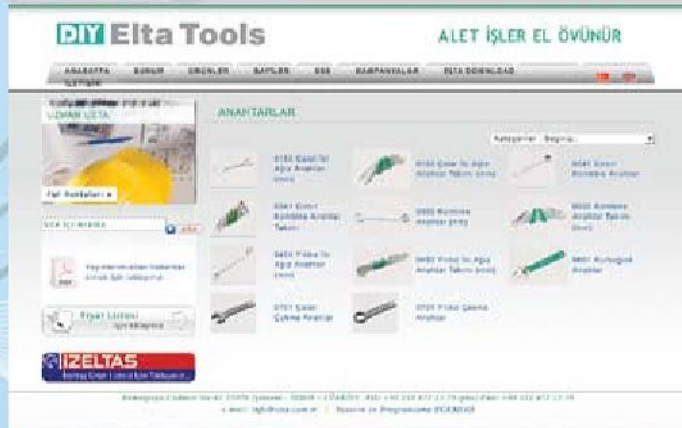
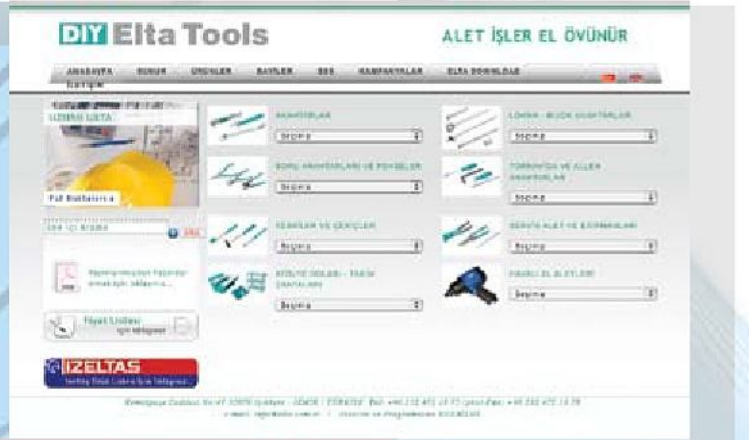

**www.eltaaletleri.com.tr**

**Sunum,**

**Son yıllarda el aletleri, profesyonel kullanıcılar yanında "DIY" (Do It Yourself-kendi işini kendin yap) veya "Homework" (ev işleri) olarak adlandırılan geniş bir kullanım alanında, giderek büyüyen ve kendi işini yapmaya özen gösteren bir kitle tarafından da kullanılmaktadır.**

**Bugüne kadar beğeni ile talep edilen ve kullanılan ELTA grubu mamüllerin ürün çeşidi, satıcı ve kullanıcılardan gelen yoğun talepler doğrultusunda sürekli olarak arttırılmıştır.**

**Tüm ELTA markalı ürünler DIN normları ile, buna eşdeğer Türk Standartlarına uygun olarak ISO 9001-2008 kalite sertifikasına sahip İZELTAŞ, İzmir tesislerinde özenle üretilmektedir.**

**Satış sonrası garantileri ve kalitesi ile TSE belgeli ELTA markalı ürünler, müşterilerine çok önemli bir güven sağlar.**

**Bugün; makine, otomotiv, ziraat, elektrik ve elektronik sektöründeki tüm profesyonel kullanıcılar tarafından, kalitesi ve ekonomik fiyatı ile, ELTA ürünleri beğeni ile tercih edilmektedir.**

**"Alet işler el övünür" ata sözünden yola çıkarak, ELTA el aletlerini kullanmakla kazanacağınız beceri ve güven, yapacağınız her türlü işte size hızlı ve başarılı çözümler sunacaktır.**

**Sağlıklı ve mutlu günlerde kullanmanız dileği ile...**

**Saygılarımızla,**

**DIY ELTA TOOLS**

# GARANTİ

## A. KAPSAM İÇİ

Aşağıda yazılı kapsam dışı haller hariç, kullanım kurallarına uygun kullanım sırasında, imalat ve malzeme hatalarına karşı ELTA el aletleri garanti kapsamında ücretsiz olarak tamir edilir veya mümkün olmadığı hallerde yenisi ile değiştirilir.

## B. KAPSAM DIŞI

Aşağıda yazılı şartlarda kullanılan aletler, garanti kapsamı dışında olup, yenisi ile değiştirilmezler veya ücretsiz olarak tamir edilmezler:

- 1- Kullanım amacı veya kullanım talimatı dışında kullanılmış olanlar.
- 2- Aşırı zorlanma ile, boru takılarak veya çekiçle vurularak kullanılması sonucu deforme olmuş yada kırılmış el aletleri.
- 3- Kullanıcı tarafından üzerinde; taşlama, zımparalama, delme veya kaynak yapılarak orijinal hali bozulmuş ürünler.
- 4- Kullanıldıktan sonra, gerekli koruyucu bakımları yapılmadan tozlu, rutubetli ve çamurlu ortamlarda bekletilerek fonksiyonu kaybolmuş aletler.
- 5- Uygun olmayan rutubetli ortamlarda, uzun süre stoklanarak paslanmış, korozyona uğramış el aletleri.

## EMNİYETLİ VE DOĞRU EL ALETİ KULLANIM KURALLARI

### A- UYULMASI GEREKEN İŞLEMLER:

- 1- Anahtarın ölçüsünün kullandığınız parçaya uygun olduğundan emin olunuz.
- 2- Kullanım esnasında aletin doğru şekilde yerleştirildiğinden emin olunuz.
- 3- Aleti sık sık kontrol ediniz ve aşınmış, zarar görmüş aletleri değiştiriniz.
- 4- Aletin kullanım şartlarını ve dayanıklılık değerlerini araştırınız.
- 5- Çakma yüzeyinin çakıldandan daha büyük olmak zorunda olduğuna dikkat ediniz.
- 6- Havalı aletlerde daima uygun aksesuar kullanınız.
- 7- Çalışma şartlarına göre kişisel koruma teçhizatı kullanınız.
- 8- Servis dolaplarını, daima kapılarını ve hareketli bölmelerini kilitledikten sonra hareket ettiriniz.
- 9- Servis dolabı üzerinde çalışırken tekerlekleri frenleyiniz.

### B- YAPILMAMASI GEREKEN İŞLEMLER:

- 1- Uzatmalar kullanarak olması gereken tork gücünü aşmayınız. (özellikle tüm anahtarlarda)
- 2- Hiçbir aleti, levye, düz keski veya kayış zımbası olarak üretim maksadına aykırı işlerde kullanmayınız. (Örneğin: tornavida)
- 3- Aşırı güç elde etmek için aleti zorlamayınız. (Örneğin; Anahtarlar ve tornavidalar)
- 4- Hiçbir zaman yüzeyi, kullandığınız aletten daha sert olan cisme vurmayınız. (Örneğin: Çekiç ve Keskiler)
- 5- Aletleri değişikliğe uğratmayınız. (Şeklini ve bir kısmını)
- 6- Metrik ölçülü anahtarı inch ölçülü civatalarda kullanmayınız ve tersini yapmayınız.
- 7- Yıpranmış ve hatalı aletleri kullanmayınız.
- 8- Servis dolabı dolu iken birden fazla çekmeceyi açık tutmayınız.
- 9- Yukarıda bahsedilen şartlarda ve doğru kullanıma riayet ederek her zaman amaca yönelik uygun aletleri kullanınız.

Anahtarlar  
Wrenches

4 - 6



1

Lokma ve Bijon Anahtarları  
Sockets and Rim Wrenches

7 - 11



2

Boru Anahtarları ve Penseler  
Pipe Wrenches and Pliers

11 - 16



3

Tornavida ve Allen Anahtarlar  
Screwdrivers and Hex Key Wrenches

16 - 22



4

Keskiler ve Çekiçler  
Chisels and Hammers

23 - 25



5

Servis Alet ve Ekipmanları  
Maintenance Tools and Equipment

25 - 26



6

Takım Çantaları ve Atölye Dolapları  
Workshop Furniture

27 - 31



7

Havalı El Aletleri  
Pneumatic Hand Tools

34 - 35



8

0150

İki Ağız Anahtar (mm)  
Double Ended Open Jaw Wrench (mm)

TS 81 • DIN 895

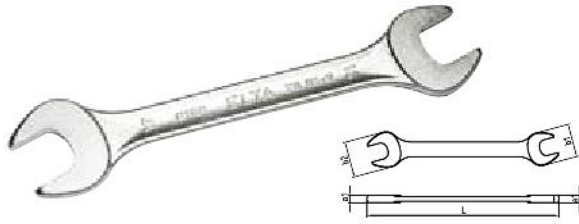

Krom vanadyum, Krom kaplı  
Chrom vanadium, Chrom plated

KOD CODE	mm	L mm	a1 mm	b1 mm	b2 mm	g	TL/Ad.
0150 01 0607	6x7	98	3.3	13.5	15.5	10	3.23
0150 01 0809	8x9	108	3.6	17.5	19.5	20	3.30
0150 01 1011	10x11	120	4	21.5	23.5	30	3.60
0150 01 1213	12x13	134	4.5	25.6	27.6	40	3.96
0150 01 1415	14x15	150	5	29.6	31.5	60	4.62
0150 01 1617	16x17	163	5.5	33.5	35.5	85	5.37
0150 01 1819	18x19	178	6	37.4	39.4	110	5.76
0150 01 2022	20x22	198	6.5	41.4	45.5	145	6.52
0150 01 2123	21x23	218	6.9	43.5	47.5	175	6.82
0150 01 2426	24x26	236	7.4	49.4	53.5	235	7.35
0150 01 2528	25x28	250	7.8	51.5	57.5	275	9.11
0150 01 2732	27x32	265	8.3	55.5	65.6	345	10.92

0150

İki Ağız Anahtar Takımı (mm)  
Double Ended Open Jaw Wrench Set (mm)



KOD CODE	İÇERİK CONTENTS	g	TL/Ad.
0150 00 2106	6x7 - 8x9 - 10x11 12x13 - 14x15 - 16x17	300	6 24.08
0150 00 2108	6x7 - 8x9 - 10x11 12x13 - 14x15 - 16x17 18x19 - 20x22	560	8 36.36
0150 00 2110	6x7 - 8x9 - 10x11 12x13 - 14x15 - 16x17 18x19 - 20x22 - 21x23 24x26	970	10 50.53
0150 00 2112	6x7 - 8x9 - 10x11 12x13 - 14x15 - 16x17 18x19 - 20x22 - 21x23 24x26 - 25x28 - 27x32	1590	12 70.56

0341

Çıracı Kombine Anahtar (mm)  
Combination Wrench With Ratchet (mm)

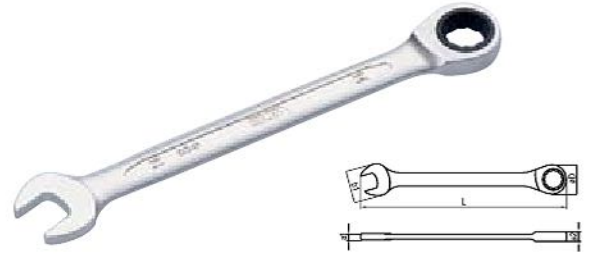

Krom vanadyum, Krom kaplı  
Chrom vanadium, Chrom plated

KOD CODE	mm	L mm	a1 mm	a2 mm	b1 mm	øD mm	g	TL/Ad.
0341 02 0008	8	140	3.9	6.5	16.7	16.4	30	10 17.05
0341 02 0009	9	150	4.3	6.9	18.7	18.6	35	10 17.60
0341 02 0010	10	160	4.6	7.3	20.7	20.5	50	10 18.18
0341 02 0011	11	165	5.2	7.7	22.8	22.2	60	10 18.75
0341 02 0012	12	170	5.4	8.2	24.9	23.2	70	10 19.31
0341 02 0013	13	180	5.5	8.7	26.9	25	85	10 20.32
0341 02 0014	14	190	6	9	29.3	27.6	105	10 21.11
0341 02 0015	15	200	6.5	9.5	31.2	28.8	120	10 22.36
0341 02 0016	16	210	7.3	9.9	33.1	30.4	145	10 24.79
0341 02 0017	17	225	7.7	10.4	35.2	32.2	165	10 25.19
0341 02 0018	18	235	7.9	10.8	37.5	33.1	195	10 26.48
0341 02 0019	19	245	8.2	11.3	39.5	34.6	225	10 27.28
0341 02 0021	21	290	8.5	13	45.2	40.3	330	10 29.76
0341 02 0022	22	290	8.7	13.1	45.6	40.3	325	10 33.91
0341 02 0024	24	325	9.7	14.6	51.5	46.3	475	5 38.92

0341

Çıracı Kombine Anahtar Takımı (mm)  
Combination Wrench With Ratchet, Set (mm)



KOD CODE	İÇERİK CONTENTS	g	TL/Ad.
0341 00 2108	8 - 9 - 10 - 11 12 - 13 - 17 - 19	720	8 163.68
0341 00 2112	8 - 9 - 10 - 11 12 - 13 - 14 - 15 16 - 17 - 18 - 19	1315	12 258.42
0341 00 2115	8 - 9 - 10 - 11 - 12 - 13 14 - 15 - 16 - 17 - 18 19 - 21 - 22 - 24	2445	15 361.01

## DIY Elta Tools

0350

Kombine Anahtar (mm)  
Combination Wrench (mm)

TS 3794 • DIN 3113

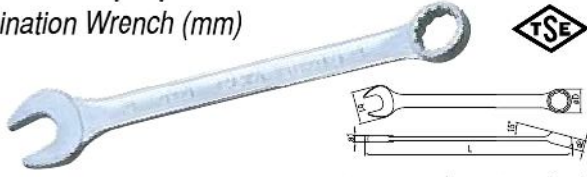

Krom vanadyum, Krom kaplı  
Chrom vanadium, Chrom plated

KOD CODE	mm	L mm	a1 mm	a2 mm	b1 mm	øD mm	g	TL/Ad.	
0350 02 0006	6	95	3.1	5.1	13.5	15.1	15	10	4.32
0350 02 0007	7	104	3.3	5.5	15.5	11.5	15	10	4.60
0350 02 0008	8	112	3.7	5.9	17.5	12.8	20	10	4.99
0350 02 0009	9	121	3.9	6.3	19.5	14.1	25	10	5.14
0350 02 0010	10	130	4.3	6.9	21.5	15.3	30	10	5.80
0350 02 0011	11	138	4.5	7.3	23.4	16.3	35	10	5.98
0350 02 0012	12	146	4.9	7.7	25.6	17.8	45	10	6.36
0350 02 0013	13	154	5.1	8.1	27.6	19	50	10	6.51
0350 02 0014	14	163	5.5	8.7	29.6	20.4	60	10	7.02
0350 02 0015	15	171	5.7	9.1	31.5	21.9	70	10	7.51
0350 02 0016	16	180	6.1	9.5	33.5	23.2	85	10	8.07
0350 02 0017	17	189	6.3	9.9	35.5	24.8	95	10	8.63
0350 02 0018	18	200	6.7	10.4	37.4	26.5	110	10	9.62
0350 02 0019	19	211	6.9	11	39.4	27.9	130	10	10.10
0350 02 0020	20	222	7.3	11.4	41.4	29.3	145	10	10.28
0350 02 0021	21	235	7.3	11.4	43.5	31	160	10	11.96
0350 02 0022	22	250	8.1	12.6	45.5	32.5	200	10	13.70
0350 02 0024	24	270	8.7	13.6	49.4	35.7	250	5	16.76
0350 02 0027	27	300	9.6	14.8	55.5	40.1	350	5	19.73
0350 02 0030	30	330	10.2	15.8	61.7	44.7	445	5	22.66
0350 02 0032	32	350	10.4	16.2	65.6	46.8	500	5	23.78

0350

Kombine Anahtar Takımı (mm)  
Combination Wrench Set (mm)

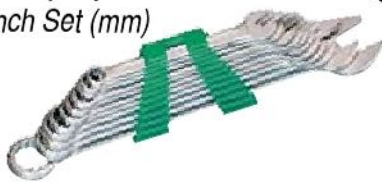

KOD CODE	İÇERİK CONTENTS	g	TL/Ad.	
0350 00 2106	8 - 9 - 11 - 13 - 17 - 19	370	6	41.35
0350 00 2108	6 - 7 - 8 - 9 - 10 - 13 - 17 - 19	395	8	50.09
0350 00 2110	8 - 9 - 10 - 11 - 12 - 13 - 14 - 17 - 19 - 22	670	10	74.23
0350 00 2112	8 - 9 - 10 - 11 - 12 - 13 - 14 - 15 - 16 - 17 - 19 - 22	855	12	89.81
0350 00 2117	6 - 7 - 8 - 9 - 10 - 11 - 12 - 13 - 14 - 15 - 16 - 17 - 18 - 19 - 20 - 21 - 22	1300	17	130.59
0350 00 2121	6 - 7 - 8 - 9 - 10 - 11 - 12 - 13 - 14 - 15 - 16 - 17 - 18 - 19 - 20 - 21 - 22 - 24 - 27 - 30 - 32	2810	21	213.52

0450

Yıldız İki Ağız Anahtar (mm)  
Double Ended Ring Wrench (mm)

TS 3794 • DIN 838

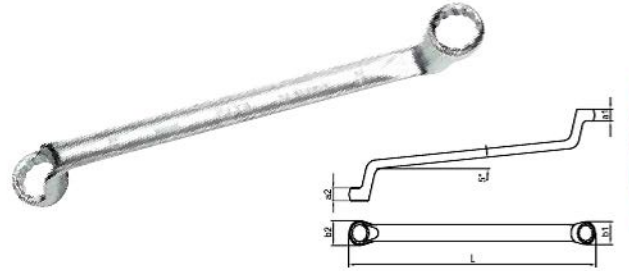

Krom vanadyum, Krom kaplı  
Chrom vanadium, Chrom plated

KOD CODE	mm	L mm	a1 mm	a2 mm	b1 mm	b2 mm	g	TL/Ad.	
0450 03 0607	6x7	176	5.5	6	10.5	11.7	45	10	7.44
0450 03 0809	8x9	190	6.5	7	13.8	15.1	60	10	7.55
0450 03 1011	10x11	206	7.5	8	16.1	17.3	90	10	8.38
0450 03 1213	12x13	220	8.5	9	19	20.5	100	10	9.48
0450 03 1415	14x15	236	9.5	10	22.2	23.8	140	10	9.95
0450 03 1617	16x17	250	10.7	11.2	25.2	26.7	190	10	11.30
0450 03 1819	18x19	271	11.7	12	28	29.5	240	10	13.47
0450 03 2022	20x22	291	12.5	13.2	31	34	255	5	14.76
0450 03 2123	21x23	310	12.8	13.4	32.7	35.6	300	5	16.93
0450 03 2426	24x26	331	13.6	14.3	37	40	335	5	19.73
0450 03 2528	25x28	350	13.8	15	38.6	43.1	430	5	21.61
0450 03 2732	27x32	371	14.8	16.4	41.5	48.5	525	5	23.79

0450

Yıldız İki Ağız Anahtar Takımı (mm)  
Double Ended Ring Wrench Set (mm)



KOD CODE	İÇERİK CONTENTS	g	TL/Ad.	
0450 00 2106	6x7 - 8x9 - 10x11 - 12x13 - 14x15 - 16x17	625	6	54.10
0450 00 2108	6x7 - 8x9 - 10x11 - 12x13 - 14x15 - 16x17 - 18x19 - 20x22	1120	8	82.33
0450 00 2110	6x7 - 8x9 - 10x11 - 12x13 - 14x15 - 16x17 - 18x19 - 20x22 - 21x23 - 24x26	1760	10	118.99
0450 00 2112	6x7 - 8x9 - 10x11 - 12x13 - 14x15 - 16x17 - 18x19 - 20x22 - 21x23 - 24x26 - 25x28 - 27x32	2710	12	164.39

**0601**

**Kurbağacak Anahtar**  
*Adjustable Wrench*

TS 3796 • DIN 3117



**Krom vanadyum, Krom kaplı, Daldırma PVC izoleli**  
*Chrom vanadium, Chrom plated, PVC dipped*

KOD CODE	L mm	L inch	a mm	g	TL/Ad.
0601 01 0008	206	8"	23	240	5 16.59
0601 01 0010	256	10"	28	400	5 21.05
0601 01 0012	306	12"	34	650	5 28.07

**0701**

**Çatal Çakma Anahtar (mm)**  
*Slugging Open Jaw Wrench (mm)*

TS 81 • DIN 133

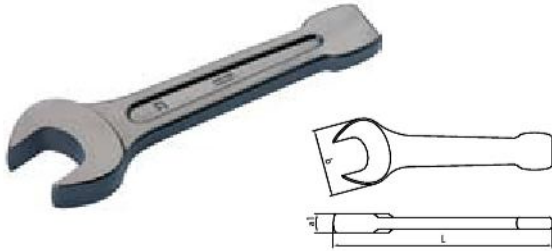

**Krom vanadyum ve yüksek alaşımli çelik**  
*Chrom vanadium and special steel*

KOD CODE	mm	L mm	a1 mm	b mm	g	TL/Ad.
0701 05 0024	24	160	15	50	280	1 21.72
0701 05 0027	27	180	16	55	400	1 26.98
0701 05 0030	30	190	17	65	525	1 33.14
0701 05 0032	32	190	17	65	530	1 37.20
0701 05 0036	36	210	19	75	780	1 41.80
0701 05 0038	38	210	19	75	760	1 50.30
0701 05 0041	41	230	19	85	920	1 54.62
0701 05 0042	42	230	19	85	930	1 63.10
0701 05 0046	46	255	21	95	1350	1 69.48
0701 05 0047	47	255	21	95	1340	1 81.15
0701 05 0050	50	275	21	105	1530	1 86.81
0701 05 0055	55	310	24	120	2435	1 116.41
0701 05 0060	60	310	24	120	2395	1 126.34
0701 05 0065	65	340	28	135	3300	1 181.79
0701 05 0070	70	375	31	155	4555	1 232.73
0701 05 0075	75	375	31	155	4460	1 246.59
0701 05 0080	80	405	34	170	6115	1 313.60
0701 05 0085	85	405	34	170	5870	1 415.75
0701 05 0090	90	445	38	190	8105	1 427.75
0701 05 0095	95	445	38	190	7895	1 456.14
0701 05 0100	100	485	44	215	11885	1 646.56

**0751**

**Yıldız Çakma Anahtar (mm)**  
*Slugging Ring Wrench (mm)*

TS 3794 • DIN 7444

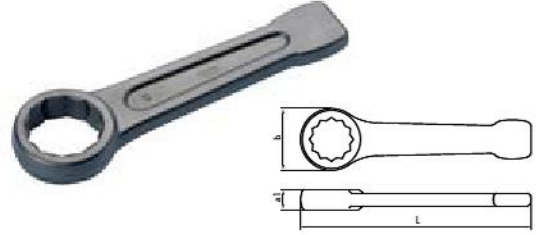

**Krom vanadyum ve yüksek alaşımli çelik**  
*Chrom vanadium and special steel*

KOD CODE	mm	L mm	a1 mm	b mm	g	TL/Ad.
0751 05 0024	24	160	15	42	235	1 24.75
0751 05 0027	27	180	16	46	340	1 29.53
0751 05 0030	30	190	17	52	450	1 35.28
0751 05 0032	32	190	17	52	445	1 40.51
0751 05 0036	36	205	19	59	560	1 45.84
0751 05 0038	38	205	19	59	540	1 54.93
0751 05 0041	41	225	20	64	750	1 59.95
0751 05 0042	42	225	20	64	730	1 68.57
0751 05 0046	46	240	22	73	995	1 71.70
0751 05 0047	47	240	22	73	985	1 79.12
0751 05 0050	50	255	23	78	1205	1 84.69
0751 05 0055	55	272	25	88	1495	1 119.12
0751 05 0060	60	272	25	88	1410	1 129.30
0751 05 0065	65	300	28	100	2025	1 169.01
0751 05 0070	70	330	32	109	2890	1 193.51
0751 05 0075	75	330	32	109	2705	1 207.10
0751 05 0080	80	360	35	123	3825	1 294.20
0751 05 0085	85	360	35	123	3635	1 331.04
0751 05 0090	90	390	40	142	5545	1 407.20
0751 05 0095	95	390	40	142	5555	1 459.14
0751 05 0100	100	420	44	152	6880	1 547.93





## DIY Elta Tools

1117

1/4" Karbüratör Lokma Takımı  
(18 parça, mm)  
Socket Wrench Set  
(18 pcs, mm)

TS ISO 3315 • DIN 3122



1/4"

KOD CODE	LOKMALAR Sockets	AVADANLIKLAR Accessories	g	TL/ Ad.
1117 00 6018	4 - 5 - 6 7 - 8 - 9 - 10 11 - 12 - 13 Altı Köşe Six Points 8 - 10 Sekiz Köşe Eight Points	1/4" Cırcır kolu Ratchet Handle 1/4" Mafsallı Universal Joint 1/4" T Kol Sliding T Handle 1/4" Ara Kol Extension Bar 54 mm 1/4" Ara Kol Extension Bar 100 mm 1/4" Mafsallı Kol Flexible Handle	960	18 86.50

1115

1/2" Altı Köşe Lokma Anahtar (mm)  
Socket Wrench 6 Points (mm)

TS ISO 2725 • DIN 3124

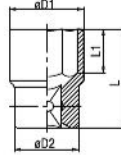

1/2"

Krom vanadyum, Krom kaplı, Polisajlı  
Chrom vanadium, Chrom plated, Polished

KOD CODE	mm	σ D1 mm	σ D2 mm	L mm	L1 mm	g	TL/ Ad.
1115 06 0010	10	15	23.3	38	8	60	5.61
1115 06 0011	11	16.4	23.3	38	8	60	5.61
1115 06 0012	12	17.8	23.3	38	9	60	5.61
1115 06 0013	13	19	23.3	38	10	60	5.61
1115 06 0014	14	20.4	23.3	38	11	60	5.61
1115 06 0015	15	21.6	23.3	38	11	65	6.02
1115 06 0016	16	22.9	24	38	11	70	6.22
1115 06 0017	17	24	22.5	38	12	70	6.52
1115 06 0018	18	25.2	23	38	13	75	6.70
1115 06 0019	19	26.8	23	38	13	75	6.70
1115 06 0020	20	28	23	38	13	80	7.60
1115 06 0021	21	29.2	23	38	13	80	5 7.60
1115 06 0022	22	30.2	24	40	15	95	5 7.60
1115 06 0023	23	31.4	25	40	15	100	5 8.78
1115 06 0024	24	32.6	26	42	17	115	5 8.78
1115 06 0026	26	35.3	28	42	17	130	5 9.88
1115 06 0027	27	36.6	28	42	19	140	5 9.88
1115 06 0028	28	37.8	30	42	20	160	5 10.42
1115 06 0030	30	40	29.5	44	21	175	5 10.42
1115 06 0032	32	42.5	30	44	23	180	5 11.13

1115

1/2" Altı Köşe Lokma Anahtar Takımı (18 Parça, mm)  
Socket Wrench Set 6 Points (18 pcs, mm)



1/2"

KOD CODE	LOKMALAR Sockets	AVADANLIKLAR Accessories	g	TL/ Ad.
1115 00 6018	10 - 11 - 12 13 - 14 - 15 17 - 19 - 22 24 - 27 - 30 32	1/2" Cırcır Kolu Ratchet Handle 1/2" U Kol Speed Brace with Revolving Rubber Handle 1/2" T Kol Sliding T Handle 1/2" Mafsallı Universal Joint 1/2" Ara Kol Extension Bar 250 mm	4775	18 210.04

1115

1/2" Altı Köşe Lokma Anahtar Takımı (24 Parça, mm)  
Socket Wrench Set 6 Points (24 pcs, mm)



1/2"

KOD CODE	LOKMALAR Sockets	AVADANLIKLAR Accessories	g	TL/ Ad.
1115 00 6024	10 - 11 - 12 13 - 14 - 15 16 - 17 - 18 19 - 21 - 22 23 - 24 - 27 28 - 30 - 32	1/2" Cırcır Kolu Ratchet Handle 1/2" U Kol Speed Brace with Revolving Rubber Handle 1/2" Mafsallı Universal Joint 1/2" T Kol Sliding T Handle 1/2" Ara Kol Extension Bar 125 mm 1/2" Ara Kol Extension Bar 250 mm	5400	24 260.97

**1514**

1/2" T Kol  
Sliding T - Handle

TS ISO 3315 • DIN 3122



Krom vanadyum, Krom kaplı, Polisajlı  
Chrom vanadium, Chrom plated, Polished

**1/2"**

KOD CODE	L mm	g	TL/Ad.
1514 06 4025	250	370	5 19.34

**1514**

1/2" Mafsal  
Universal Joint

TS ISO 1174 • DIN 3123



Krom vanadyum, Krom kaplı, Polisajlı  
Chrom vanadium, Chrom plated, Polished

**1/2"**

KOD CODE	L mm	g	TL/Ad.
1514 06 4065	65	140	5 16.08

**1514**

1/2" Ara Kol  
Extension Bar

TS ISO 1174 • DIN 3123



Krom vanadyum, Krom kaplı, Polisajlı  
Chrom vanadium, Chrom plated, Polished

**1/2"**

KOD CODE	L mm	g	TL/Ad.
1514 06 4125	125	220	5 11.21
1514 06 4250	250	425	5 16.21

**1514**

1/2" U Kol  
Speed brace with revolving rubber handle

TS ISO 3315 • DIN 3122

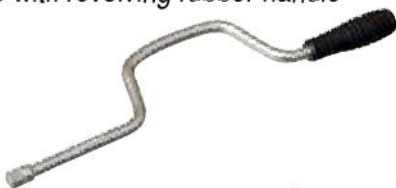

Krom vanadyum, Krom kaplı, Polisajlı  
Chrom vanadium, Chrom plated, Polished

**1/2"**

KOD CODE	L mm	g	TL/Ad.
1514 06 4420	420	510	5 26.81

**1514**

1/2" Cıracı Kolu  
Ratchet Handle

TS ISO 3315 • DIN 3122



Krom vanadyum, Krom kaplı, Polisajlı  
Chrom vanadium, Chrom plated, Polished

**1/2"**

KOD CODE	L mm	g	TL/Ad.
1514 06 5250	250	585	5 36.50

**1115**

1/2" Altı Köşe Havalı Lokma Anahtar (mm)  
Impact Socket Wrench 6 Points (mm)

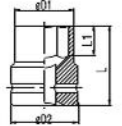

Krom molibden, Fosfat kaplamalı  
Chrom molybdenum, Phosphate finish

**1/2"**

KOD CODE	mm	σ D1 mm	σ D2 mm	L mm	L1 mm	g	TL/Ad.
1115 06 7010	10	17	25	38	8	70	10 5.94
1115 06 7011	11	18	25	38	8	70	10 5.94
1115 06 7012	12	19	25	38	9	70	10 5.94
1115 06 7013	13	20	25	38	10	70	10 5.94
1115 06 7014	14	22	25	38	10	75	10 5.94
1115 06 7015	15	23	30	38	11	110	10 6.71
1115 06 7016	16	24	30	38	11	110	10 6.71
1115 06 7018	18	27	30	38	13	115	10 7.78
1115 06 7021	21	30	30	40	14	125	5 8.91
1115 06 7022	22	32	30	40	14	145	5 8.91
1115 06 7024	24	34	30	42	15	150	5 10.40
1115 06 7027	27	38	30	44	16	175	5 12.00

**1514**

1/2" Havalı Lokma Mafsal  
Impact Socket Universal Joint



Krom molibden, Fosfat kaplamalı  
Chrom molybdenum, Phosphate finish

**1/2"**

KOD CODE	L mm	g	TL/Ad.
1514 06 7065	75	220	5 29.94

## DIY Elta Tools

1514

1/2" Havalı Lokma Ara Kol  
Impact Socket Extension Bar



1/2"

Krom molibden, Fosfat kaplamalı  
Chrom molybdenum, Phosphate finish

KOD CODE	L mm	g		TL/Ad.
1514 06 7125	125	275	5	17.53
1514 06 7250	250	450	5	24.12

1121

3/4" Altı Köşe Lokma Anahtar (mm)  
Socket Wrench 6 Points (mm)

TS ISO 2725 • DIN 3124

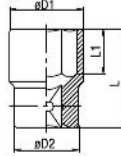

3/4"

Krom vanadyum, Krom kaplı, Polisajlı  
Chrom vanadium, Chrom plated, Polished

KOD CODE	mm	σ D1 mm	σ D2 mm	L mm	L1 mm	g		TL/Ad.
1121 06 0022	22	33	36	52	16	220	5	11.07
1121 06 0024	24	35	36	52	16	220	5	11.38
1121 06 0027	27	38	36	52	19	235	5	12.13
1121 06 0030	30	42	38	54	21	295	5	12.70
1121 06 0032	32	44	38	56	23	325	5	13.62
1121 06 0034	34	47	42	58	24	400	5	15.35
1121 06 0036	36	50	42	58	25	445	5	17.36
1121 06 0041	41	56	45	64	29	570	5	22.71
1121 06 0046	46	62	48	68	33	725	1	26.12
1121 06 0050	50	68	48	72	34	905	1	29.59
1121 06 0055	55	76	48	76	37	1095	1	39.09
1121 06 0060	60	80	48	78	38	1275	1	44.69



1121

3/4" Altı Köşe Lokma Anahtar Takımı (14 parça, mm)  
Socket Wrench Set 6 Points (14 pcs, mm)



3/4"

KOD CODE	LOKMALAR Sockets	AVADANLIKLAR Accessories	g		TL/Ad.
1121 00 6014	22 - 24 - 27 30 - 32 - 34 36 - 41 - 46 50	3/4" Cırcır Kolu Ratchet Handle	13400	14	369.04
		3/4" T Kol Sliding T Handle			
		3/4" Ara Kol Extension Bar 200 mm			
		3/4" Ara Kol Extension Bar 400 mm			

1521

3/4" Ara Kol  
Extension Bar

TS ISO 1174 • DIN 3123



3/4"

Krom vanadyum, Krom kaplı, Polisajlı  
Chrom vanadium, Chrom plated, Polished

KOD CODE	L mm	g		TL/Ad.
1521 06 4200	200	730	5	25.48
1521 06 4400	400	1380	5	38.79

1521

3/4" T Kol  
Sliding T - Handle

TS ISO 3315 • DIN 3122



3/4"

Krom vanadyum, Krom kaplı, Polisajlı  
Chrom vanadium, Chrom plated, Polished

KOD CODE	L mm	g		TL/Ad.
1521 06 4500	500	1490	5	36.12

**1521**

3/4" Cıracı Kolu  
Ratchet Handle

TS ISO 3315 • DIN  
3122



**3/4"**

Krom vanadyum, Krom kaplı, Polijalı  
Chrom vanadium, Chrom plated, Polished

KOD CODE	L mm	g		TL/Ad.
1521 06 5510	510	2250	5	96.62

**1521**

3/4" Havalı Lokma Ara Kol  
Impact Socket Extension Bar



**3/4"**

Krom molibden, Fosfat kaplamalı  
Chrom molybdenum, Phosphate finish

KOD CODE	L mm	g		TL/Ad.
1521 06 7175	175	865	5	34.34
1521 06 7250	250	1155	5	44.31
1521 06 7330	330	1425	5	56.79

**1121**

3/4" Altı Köşe Havalı Lokma Anahtar (mm)  
Impact Socket Wrench 6 Points (mm)



**1801**

Kovan Anahtar İki Ağız (mm)  
Double Ended Tubular Socket Wrench (mm)

TS ISO 3793 • DIN 896

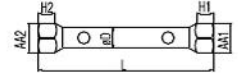

Dikisiz çelik boru, Çinko kaplı  
Seamless steel tube, Zinc plated.

**3/4"**

Krom molibden, Fosfat kaplamalı  
Chrom molybdenum, Phosphate finish

KOD CODE	mm	σ D1 mm	σ D2 mm	L mm	L1 mm	g		TL/Ad.
1121 06 7019	19	32	44	50	12	315	5	18.00
1121 06 7021	21	35	44	50	15	340	5	18.00
1121 06 7022	22	36	44	50	15	345	5	18.00
1121 06 7024	24	38	44	50	16	350	1	18.00
1121 06 7027	27	42	44	53	17	380	1	18.59
1121 06 7030	30	46	44	53	20	410	1	19.36
1121 06 7032	32	48	44	57	20	460	1	19.36
1121 06 7034	34	51	44	57	22	490	1	19.96
1121 06 7036	36	53	44	57	22	520	1	25.37
1121 06 7041	41	59	44	58	24	580	1	34.57
1121 06 7046	46	66	44	62	24	720	1	34.57

KOD CODE	mm	L mm	AA1 mm	AA2 mm	H1 mm	H2 mm	σ D mm	g		TL/Ad.
1801 07 0607	6x7	105	8.6	9.6	7	8	8	25	5	6.46
1801 07 0809	8x9	105	11.2	12.2	9	10	10	35	5	7.10
1801 07 1011	10x11	120	13.6	14.6	11	11.5	12	60	5	9.79
1801 07 1213	12x13	135	16	17	12	12.5	14	80	5	10.37
1801 07 1415	14x15	135	18.5	19.5	13	13.5	16	110	5	11.39
1801 07 1617	16x17	150	21	22	14	14.5	18	150	5	12.20
1801 07 1819	18x19	150	23	24	15	15.5	20	175	5	12.69
1801 07 2022	20x22	165	25.4	27.4	16	18	22	220	5	13.96
1801 07 2123	21x23	165	26.4	28.4	17	19	24	240	5	15.65
1801 07 2426	24x26	180	30.4	32.4	20	22	26	340	5	20.30
1801 07 2528	25x28	200	31.4	34.4	21	24	28	400	5	23.92
1801 07 2732	27x32	200	33.4	38.4	23	26	30	435	5	27.82

**1521**

3/4" Havalı Lokma Mafsal  
Impact Socket Universal Joint



**3/4"**

Krom molibden, Fosfat kaplamalı  
Chrom molybdenum, Phosphate finish

KOD CODE	L mm	g		TL/Ad.
1521 06 7108	108	735	1	59.81



## DIY Elta Tools

1801

Kovan Anahtar Takımı İki Ağz (mil dahil, mm)  
Double Ended Tubular Socket Wrench Set  
with Handle Bars (mm)



KOD CODE	mm	g		TL/Ad.
1801 00 2106	6x7 - 8x9 - 10x11 12x13 - 14x15 - 16x17	450	6	57.31
1801 00 2108	6x7 - 8x9 - 10x11 12x13 - 14x15 - 16x17 18x19 - 20x22	920	8	83.96
1801 00 2110	6x7 - 8x9 - 10x11 12x13 - 14x15 - 16x17 18x19 - 20x22 - 21x23 24x26	1615	10	119.91
1801 00 2112	6x7 - 8x9 - 10x11 12x13 - 14x15 - 16x17 18x19 - 20x22 - 21x23 24x26 - 25x28 - 27x32	2445	12	171.65

1875

Ağır Tip Bijon Anahtarı İki Ağz Uzun  
Double Ended Rim Wrench with Handle Bar (long)

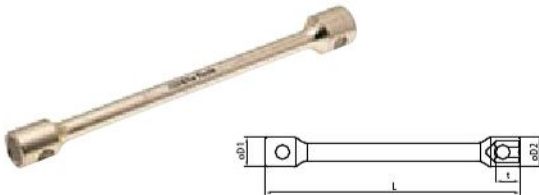

Özel alaşımlı çelik, Çinko kaplı  
Special steel, Zinc plated

KOD CODE	mm	L mm	t mm	σD1 mm	σD2 mm	g	g		TL/Ad.
1875 09 2224	22x24	400	34.5	34	36	1060	2310	10	22.39
1875 09 2227	22x27	400	34.5	34	40	1060	2310	10	22.63
1875 09 2427	24x27	400	34.5	36	40	1060	2310	10	22.87
1875 09 2430	24x30	400	34.5	36	44	1150	2395	10	23.48
1875 09 2730	27x30	400	34.5	40	44	1250	2495	10	24.33
1875 09 2732	27x32	400	34.5	40	46	1300	2545	10	25.48
1875 09 3032	30x32	400	34.5	44	46	1380	2625	10	28.80
1875 09 3233	32x33	400	34.5	46	47	1430	2675	10	29.17

1875

Bijon Anahtar Mili  
Tommy Bar

TS ISO 3793 • DIN 900

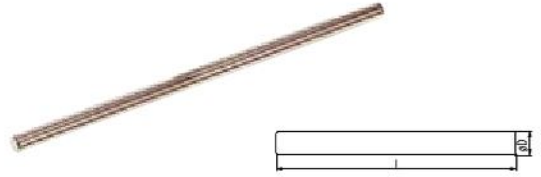

KOD CODE	σDxL mm	g		TL/Ad.
1875 09 1630	18x630	1245	1	14.95

1974

Bijon Anahtarı İstavroz Tipi  
Cross Rim Wrench

DIN 3119



Özel alaşım çelik, Çinko kaplı  
Special steel, Zinc plated

KOD CODE	mm	inch	σd mm	h mm	L mm	σd mm	g		TL/Ad.
1974 09 1719	17	11/16"	26	12	420	15	1190	10	20.61
	19	3/4"	28	14					
	21	13/16"	30	16					
	22	7/8"	32	17					

2203

Maşalı Boru Anahtarı (85°)  
Pipe Wrench (85°)

DIN 5234



Krom vanadyum, Dişler indüksiyonda sertleştirilmiş, Elektrostatik boyanmış  
Chrom vanadium, Teeth induction hardened, Electrostatically painted

KOD CODE	L mm	mm	inch	g		TL/Ad.
2203 10 0010	310	45	1"	760	1	37.15
2203 10 0015	425	60	1 1/2"	1360	1	44.79
2203 10 0020	560	75	2"	2350	1	62.73
2203 10 0030	760	105	3"	3200	1	100.34

**2401**

**Fort Pense**  
*Waterpump Pliers*

TS 60 • DIN ISO 8976



**Krom vanadyum, Krom kaplı, Daldırma PVC izoleli**  
*Chrom vanadium, Chrom plated, PVC dipped*

KOD CODE	L mm	L inch	mm	g	TL/Ad.
2401 11 0240	240	9 1/2"	35	375	5 22.22

**2509**

**Ayarlı Pense**  
*Grip*



**Çeneler krom vanadyum çeliğinden dövülmüştür, Nikel kaplama,**  
**Kullanım sahası: Yuvarlak ve düz malzemeler**  
*Jaws Chrom vanadium forged, Nickel plated*  
*Applicatation field : Fat and round materials*

KOD CODE	L mm	L inch	mm	g	TL/Ad.
2509 11 0225	225	9"	30	470	1 14.21

**3021**

**Kombine Pense**  
*Combination Pliers*

TS 60 • TS 11068 • DIN ISO 5744  
DIN ISO 5746



**Özel alaşımli çelik, Kesici ağızlar indüksiyonda sertleştirilmiş,**  
**Krom kaplı, PVC saplı**  
*Special steel, Cutters induction hardened,*  
*Chrom plated, PVC handle*

KOD CODE	L mm	L inch	MODEL	g	TL/Ad.
3021 12 1160	160	6 1/4"	OPAK	200	5 14.50
3021 12 1180	180	7 1/8"	OPAK	250	5 16.82
3021 12 1200	200	8"	OPAK	310	5 18.64

**3021**

**Kombine Pense**  
*Combination Pliers*

TS 60 • TS 11068 • DIN ISO 5744  
DIN ISO 5746



**Özel alaşımli çelik, Kesici ağızlar indüksiyonda sertleştirilmiş,**  
**Krom kaplı, iki komponent saplı**  
*Special steel, Cutters induction hardened,*  
*Chrom plated, two component handle*

KOD CODE	L mm	L inch	MODEL	g	TL/Ad.
3021 12 2160	160	6 1/4"	ERGONOM	205	5 15.96
3021 12 2180	180	7 1/8"	ERGONOM	265	5 18.56
3021 12 2200	200	8"	ERGONOM	325	5 20.50

**3052**

**Fit Pense**  
*Standard Pliers*

TS 60 • TS 11068 • DIN 5744



**Özel alaşımli çelik, Kesici ağızlar indüksiyonda sertleştirilmiş,**  
**Daldırma PVC izoleli**  
*Special steel, Cutters induction hardened, PVC dipped*

KOD CODE	L mm	L inch	g	TL/Ad.
3052 12 0200	200	8"	275	5 17.14



## DIY Elta Tools

3221

Uzun Kargaburun Düz Uçlu  
Long Nose Pliers (Flat)

TS 60 • TS 11067

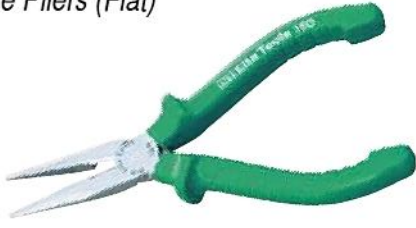

Özel alaşımli çelik, Kesici ağızlar indüksiyonda sertleştirilmiş,  
Krom kaplı, PVC saplı  
Special steel, Cutters induction hardened,  
Chrom plated, PVC handle

KOD CODE	L mm	L inch	MODEL	g	TL/Ad.
3221 13 1160	160	6 1/4"	OPAK	145	5 14.38
3221 13 1200	200	8"	OPAK	190	5 15.88

3221

Uzun Kargaburun Düz Uçlu  
Long Nose Pliers (Flat)

TS 60 • TS 11067



Özel alaşımli çelik, Kesici ağızlar indüksiyonda sertleştirilmiş,  
Krom kaplı, iki komponent saplı  
Special steel, Cutters induction hardened,  
Chrom plated, two component handle

KOD CODE	L mm	L inch	MODEL	g	TL/Ad.
3221 13 2160	160	6 1/4"	ERGONOM	150	5 15.79
3221 13 2200	200	8"	ERGONOM	200	5 17.45

3303

Dış Segman Pense (Yaylı Düz)  
Circlip Pliers, External (Flat)

TS 60 • DIN 5254



Krom vanadyum, Krom kaplı, Daldırma PVC izoleli  
Chrom vanadium, Chrom plated, PVC dipped

KOD CODE	L mm	g	TL/Ad.
3303 12 0140	140	10 - 25	90 5 27.20
3303 12 0180	180	19 - 60	165 5 28.63
3303 12 0220	220	40 - 100	315 5 35.80

3304

Dış Segman Pense (Yaylı Eğri)  
Circlip Pliers, External (Bent)

TS 60 • DIN 5254



Krom vanadyum, Krom kaplı, Daldırma PVC izoleli  
Chrom vanadium, Chrom plated, PVC dipped

KOD CODE	L mm	g	TL/Ad.
3304 12 0125	125	10 - 25	90 5 30.35
3304 12 0170	170	19 - 60	160 5 31.97
3304 12 0200	200	40 - 100	315 5 39.88

3323

İç Segman Pensi (Yaysız Düz)  
Circlip Pliers Internal (Flat)

TS 60 • DIN 5256

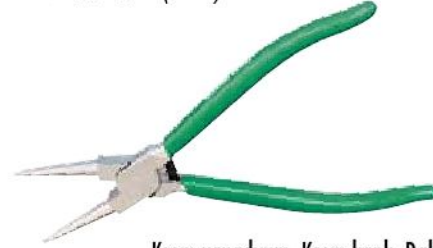

Krom vanadyum, Krom kaplı, Daldırma PVC izoleli  
Chrom vanadium, Chrom plated, PVC dipped

KOD CODE	L mm	g	TL/Ad.
3323 12 0140	140	8 - 25	90 5 25.01
3323 12 0180	180	19 - 60	140 5 26.36
3323 12 0230	230	40 - 100	300 5 32.87

3324

İç Segman Pensi (Yaysız Eğri)  
Circlip Pliers Internal (Bent)

TS 60 • DIN 5256



Krom vanadyum, Krom kaplı, Daldırma PVC izoleli  
Chrom vanadium, Chrom plated, PVC dipped

KOD CODE	L mm	g	TL/Ad.
3324 12 0130	130	8 - 25	90 5 26.88
3324 12 0170	170	19 - 60	140 5 28.30
3324 12 0210	210	40 - 100	300 5 35.31

3541

**Elektronikçi Yan Keski**  
Electronic Diagonal Side Cutting Pliers



**Yüksek karbonlu krom nikel çeliği,**  
Kesici ağızlar indüksiyonda sertleştirilmiş, Daldırma PVC izoleli  
High carbon chrom nickel steel drop forged,  
Heat treated, Cutters induction hardened, PVC dipped

KOD CODE	L mm	g	TL/Ad.
3541 14 0115	115	70	5 12.81

3544

**Elektronikçi Düz Uçlu Kargaburun**  
Electronic Flat Nose Pliers



**Yüksek karbonlu krom nikel çeliği,** Daldırma PVC izoleli  
High carbon chrom nickel steel drop forged, PVC dipped

KOD CODE	L mm	g	TL/Ad.
3544 14 0135	135	70	5 12.81

3542

**Elektronikçi Tepe Keski**  
Electronic End Cutting Pliers



**Yüksek karbonlu krom nikel çeliği,**  
Kesici ağızlar indüksiyonda sertleştirilmiş, Daldırma PVC izoleli  
High carbon chrom nickel steel drop forged,  
Heat treated, cutters induction hardened, PVC dipped

KOD CODE	L mm	g	TL/Ad.
3542 14 0105	105	60	5 13.40

3545

**Elektronikçi Düz Uçlu Uzun Kargaburun**  
Electronic Long Nose Pliers



**Yüksek karbonlu krom nikel çeliği,**  
Kesici ağızlar indüksiyonda sertleştirilmiş, Daldırma PVC izoleli  
High carbon chrom nickel steel drop forged,  
Cutters induction hardened, PVC dipped

KOD CODE	L mm	g	TL/Ad.
3545 14 0130	130	70	5 12.81

3543

**Elektronikçi Yuvarlak Uçlu Kargaburun**  
Electronic Round Nose Pliers



**Yüksek karbonlu krom nikel çeliği,** Daldırma PVC izoleli  
High carbon chrom nickel steel drop forged, PVC dipped

KOD CODE	L mm	g	TL/Ad.
3543 14 0120	120	60	5 12.81

3546

**Elektronikçi Eğri Uçlu Uzun Kargaburun**  
Electronic Bent Nose Pliers



**Yüksek karbonlu krom nikel çeliği,** Daldırma PVC izoleli  
High carbon chrom nickel steel drop forged, PVC dipped

KOD CODE	L mm	g	TL/Ad.
3546 14 0120	120	65	5 12.81



## DIY Elta Tools

3547

Elektronikçi Sivri Uçlu Düz Kargaburun  
Electronic Needle Nose Pliers



Yüksek karbonlu krom nikel çeliği, Daldırma PVC izoleli  
High Carbon chrom nickel steel drop forged, PVC dipped

KOD CODE	L mm	g	TL/Ad.
3547 14 0145	145	75	5 13.40

3548

Elektronikçi Sivri Uçlu Eğri Kargaburun  
Electronic Bent Needle Nose Pliers



Yüksek karbonlu krom nikel çeliği, Daldırma PVC izoleli  
High carbon chrom nickel steel drop forged, PVC dipped

KOD CODE	L mm	g	TL/Ad.
3548 14 0145	145	75	5 15.40

3549

Elektronikçi Pense  
Electronic Pliers



Yüksek karbonlu krom nikel çeliği,  
Kesici ağızlar indüksiyonda sertleştirilmiş, Daldırma PVC izoleli  
High carbon chrom nickel steel drop forged,  
Cutters induction hardened, PVC dipped

KOD CODE	L mm	g	TL/Ad.
3549 14 0110	110	75	5 13.40

3701

Yan Keski  
Side Cutting Pliers

TS 60 • DIN ISO 5749



Özel alaşımli çelik, Kesici ağızlar indüksiyonda sertleştirilmiş,  
Krom kaplı, PVC saplı  
Special steel, Cutters induction hardened,  
Chrom plated, PVC handle

KOD CODE	L mm	L inch	MODEL	g	TL/Ad.
3701 16 1140	140	5 1/2"	OPAK	160	5 11.30
3701 16 1160	160	6 1/4"	OPAK	220	5 14.12

3701

Yan Keski  
Side Cutting Pliers

TS 60 • DIN ISO 5749



Özel alaşımli çelik, Kesici ağızlar indüksiyonda sertleştirilmiş,  
Krom kaplı, iki komponent saplı  
Special steel, Cutters induction hardened,  
Chrom plated, two component handle

KOD CODE	L mm	L inch	MODEL	g	TL/Ad.
3701 16 2140	140	5 1/2"	ERGONOM	170	5 12.43
3701 16 2160	160	6 1/4"	ERGONOM	230	5 15.53

3801

Kerpeten  
Carpenter Pincers

TS 60 • DIN ISO 9243



Özel alaşımli çelik, Kesici ağızlar indüksiyonda sertleştirilmiş,  
Vernikli, Daldırma PVC izoleli  
Special steel, Cutters induction hardened,  
Lacquered, PVC dipped

KOD CODE	L mm	L inch	g	TL/Ad.
3801 15 0160	160	6 1/4"	235	5 13.23
3801 15 0180	180	7 1/8"	245	5 14.53
3801 15 0200	200	8"	390	5 14.93

3832

Betoncu Kerpeteni  
Tower Pincers

TS 60 • DIN ISO 9242



Özel alaşımlı çelik, Kesici ağızlar indüksiyonda sertleştirilmiş,  
Vernikli, Daldırma PVC izoleli  
Special steel, Cutters induction hardened,  
Lacquered, PVC insulated

KOD CODE	L mm	L inch	g	TL/Ad.
3832 15 0225	225	9"	335	5 15.25
3832 15 0250	250	10"	415	5 16.44
3832 15 0280	280	11"	475	5 18.02

4150

Opak Seri Düz Uçlu Tornavida  
Screwdriver, Opaque, Flat

TS 59 • DIN 5264 • DIN 5265

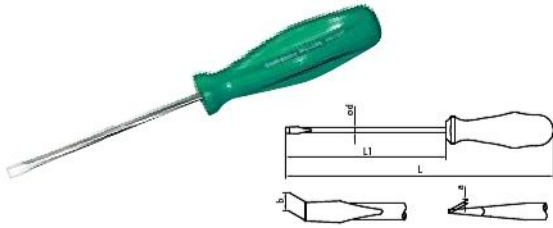

Krom vanadyum, Krom kaplı, PP saplı  
Chrom vanadium, Chrom plated, PP handle.

KOD CODE	ØDxL1 mm	-		L mm	g	TL/Ad.
		a mm	b mm			
4150 17 0380	3x80	0.5	3	150	20	10 3.74
4150 17 0480	4x80	0.8	4	170	30	10 3.90
4150 17 4100	4x100	0.8	4	190	40	10 4.69
4150 17 5100	5x100	1.0	5.5	200	55	10 5.68
4150 17 5125	5x125	1.0	5.5	225	60	10 6.57
4150 17 6100	6x100	1.2	6.5	200	70	10 5.89
4150 17 6125	6x125	1.2	6.5	225	75	10 6.76
4150 17 6150	6x150	1.2	6.5	250	80	10 7.37
4150 17 7150	7x150	1.2	8	260	110	10 8.68
4150 17 8150	8x150	1.6	10	260	130	10 9.60
4150 17 8175	8x175	1.6	10	285	135	10 10.53



4150

Opak Seri Tornavida Seti (6 parça)  
Screwdriver, Opaque Set (6 Pcs)



KOD CODE	İÇERİK CONTENTS	g	TL/Ad.
4150 00 8106	4x80 - 5x100 - 6x125	545	1 38.25
	7x150		
	Düz uçlu/Flat		
	4.5x80 - 6x100		
	Yıldız uçlu/Phillips		

4150

Opak Seri Tornavida Seti (7 parça)  
Screwdriver, Opaque Set (7 Pcs)



KOD CODE	İÇERİK CONTENTS	g	TL/Ad.
4150 00 8107	3x80 - 4x100 - 5x125	605	1 46.13
	6x150 - 8x175		
	Düz uçlu/Flat		
	4.5x80 - 6x100		
	Yıldız uçlu/Phillips		



## DIY Elta Tools

4170

Opak Seri Yıldız Uçlu Tornavida  
Screwdriver, Opaque Phillips

TS 59 • DIN ISO 8764

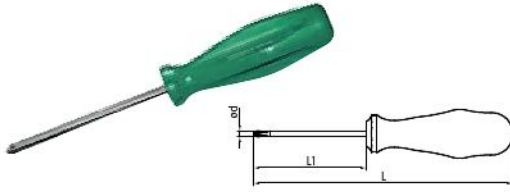

Krom vanadyum, Krom kaplı, PP saplı  
Chrom vanadium, Chrom plated, PP handle

KOD CODE	∅DxL1 mm	+	L mm	g	TL/Ad.
4170 18 0360	3x60	Ph0	130	15	10 4.58
4170 18 4580	4.5x80	Ph1	170	45	10 6.00
4170 18 6100	6x100	Ph2	200	70	10 7.23
4170 18 8150	8x150	Ph3	260	130	10 13.78

4160

Ergonom Seri Düz Uçlu Tornavida  
Screwdriver, Ergonom, Flat

TS 59 • DIN 5264 • DIN 526

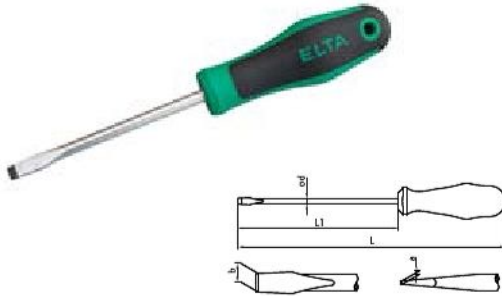

Krom vanadyum, Krom kaplı, Ucu siyah oksit, İki komponent saplı  
Chrom vanadium, Chrom plated and black tips,  
Two component handle.

KOD CODE	∅DxL1 mm	-		L mm	g	TL/Ad.
		a mm	b mm			
4160 17 0380	3x80	0.5	3	160	25	10 4.12
4160 17 0480	4x80	0.8	4	170	40	10 4.28
4160 17 0580	5x80	1.0	5.5	180	45	10 4.72
4160 17 4100	4x100	0.8	4	190	45	10 5.16
4160 17 5100	5x100	1.0	5.5	200	60	10 6.25
4160 17 6100	6x100	1.2	6.5	200	85	10 6.47
4160 17 5125	5x125	1.0	5.5	225	65	10 7.23
4160 17 6125	6x125	1.2	6.5	225	90	10 7.43
4160 17 7125	7x125	1.2	8	235	100	10 7.51
4160 17 5150	5x150	1.6	10	250	85	10 7.75
4160 17 6150	6x150	1.2	6.5	250	90	10 8.11
4160 17 7150	7x150	1.2	8	260	130	10 9.55
4160 17 8150	8x150	1.6	10	260	135	10 10.55
4160 17 7175	7x175	1.2	8	285	130	10 11.02
4160 17 8175	8x175	1.6	10	285	140	10 11.59

4160

Ergonom Seri Tornavida Seti (6 Parça)  
Screwdriver, Ergonom Set (6 Pcs.)



KOD CODE	İÇERİK CONTENTS	g	TL/Ad.
4160 00 8106	4x80 - 5x100	600	1 41.40
	6x125 - 7x150		
	Düz uçlu/Flat		
	4.5x80 - 6x100		
	Yıldız uçlu/Phillips		

4160

Ergonom Seri Tornavida Seti (7 Parça)  
Screwdriver, Ergonom Set (7 Pcs.)



KOD CODE	İÇERİK CONTENTS	g	TL/Ad.
4160 00 8107	3x80 - 4x80 - 4x100	670	1 42.79
	5x125 - 6x150		
	Düz uçlu/Flat		
	4.5x80 - 6x100		
	Yıldız uçlu/Phillips		



4180

Ergonom Seri Yıldız Uçlu Tornavida  
Screwdriver, Ergonom, Phillips

TS 59 • DIN ISO 58764



Krom vanadyum, Krom kaplı, Ucu siyah oksit, İki komponent saplı  
Chrom vanadium, Chrom plated and black tips,  
Two component handle.

KOD CODE	øDxL1 mm	+	L mm	g	TL/Ad.
4180 18 0360	3x60	Ph0	140	25	10 4.81
4180 18 4580	4.5x80	Ph1	170	40	10 6.30
4180 18 4510	4.5x100	Ph1	190	60	10 7.04
4180 18 6100	6x100	Ph2	200	70	10 7.59
4180 18 4515	4.5x150	Ph1	240	75	10 7.40
4180 18 6150	6x150	Ph2	250	110	10 9.48
4180 18 8150	8x150	Ph3	260	130	10 14.47

4181

Değişken Uçlu Tornavida Ergonom  
Screwdriver - Reversible

TSEK

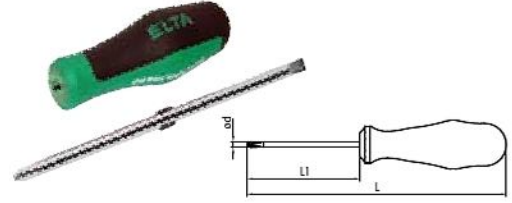

Krom vanadyum, Krom kaplı iki komponent saplı  
Chrom vanadium, Chrom plated, Two component handle.

KOD CODE	øDxL1 mm	-	+	L mm	g	TL/Ad.
4181 17 0680	6x80	6x1.2	Ph2	180	70 10	6.82

4501

Elektronikçi Tip (Klemens) Düz Uçlu Tornavida  
Electronic Screwdriver, Flat

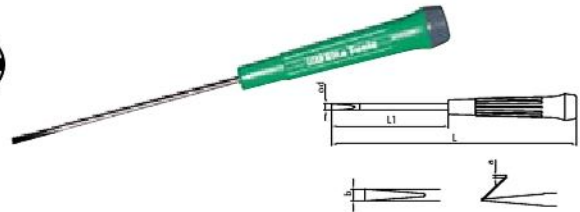

Krom vanadyum, Krom kaplı, Ucu siyah oksit, PP saplı  
Chrom vanadium, Chrom plated and black tips, PP handle

KOD CODE	øDxL1 mm	-		L mm	g	TL/Ad.
		a mm	b mm			
4501 17 0380	3x80	0.5	3	160	15 10	3.91
4501 17 3100	3x100	0.5	3	180	20 10	4.77
4501 17 3125	3x125	0.5	3	205	20 10	6.31
4501 17 4100	4x100	0.8	4	180	25 10	4.93
4501 17 4150	4x150	0.8	4	230	25 10	7.23

4521

Elektronikçi Tip (Klemens) Yıldız Uçlu Tornavida  
Electronic Screwdriver, Phillips

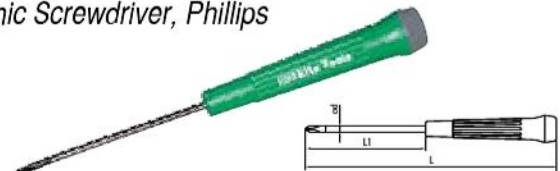

Krom vanadyum, Krom kaplı, Ucu siyah oksit, PP saplı  
Chrom vanadium, Chrom plated and black tips, PP handle

KOD CODE	øDxL1 mm	+	L mm	g	TL/Ad.
4521 18 0360	3x60	Ph0	140	15	10 4.13
4521 18 0480	4x80	Ph0	160	20	10 5.93
4521 18 4150	4x150	Ph0	230	30	10 7.96

4170

Değişken Uçlu Tornavida  
Screwdriver - Reversible

TSEK

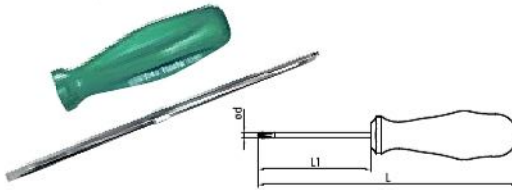

Krom vanadyum, Krom kaplı, PP saplı  
Chrom vanadium, Chrom plated, PP handle

KOD CODE	øDxL1 mm	-	+	L mm	g	TL/Ad.
4170 17 0680	6x80	6x1.2	Ph2	170	60 10	6.51

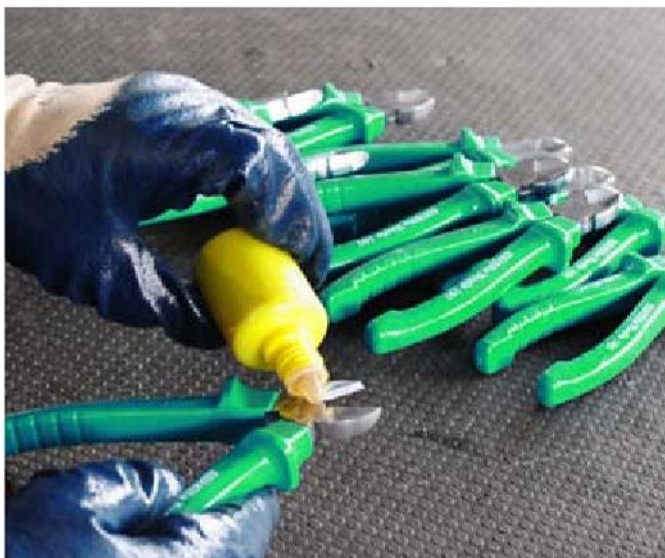

## DIY Elta Tools

4501

Elektronikçi Tip (Klemens) Tornavida Seti (6 Parça)  
Electronic Screwdriver Set (6 Pcs)



KOD CODE	İÇERİK CONTENTS	g		TL/Ad.
4501 00 8106	3x80 - 3x100	205	1	32.28
	3x125 - 4x150			
	Düz uçlu/Flat			
	3x60 - 4x80			
	Yıldız uçlu/Phillips			

4552

Elektrik Kontrol Kalemi  
Voltage Tester

TS 13108



Krom vanadyum, Krom kaplı, Selüloz asetat saplı  
Chrom vanadium, Chrom plated, Cellulose acetate handle

KOD CODE	L mm	Ø		L1 mm	g		TL/Ad.
		a mm	b mm				
4552 17 0190	190	0.8	4	100	35	10	8.97



4771

Lokma Uçlu Tornavida (mm)  
Nut Spinner (mm)

TS 3793 • DIN 3125

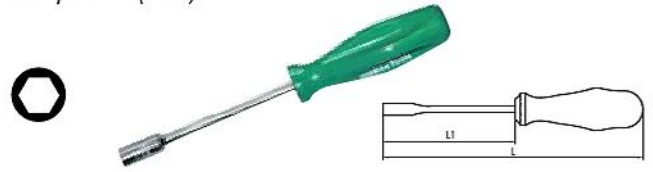

Krom vanadyum, Krom kaplı, PP saplı  
Chrom vanadium, Chrom plated, PP handle

KOD CODE	Ø mm	L mm	L1 mm	g		TL/Ad.
4771 19 0040	4	225	125	80	10	10.97
4771 19 0050	5	225	125	80	10	10.97
4771 19 0055	5.5	225	125	80	10	10.97
4771 19 0060	6	225	125	80	10	10.97
4771 19 0070	7	235	125	110	10	12.13
4771 19 0080	8	235	125	110	10	12.65
4771 19 0090	9	235	125	115	10	13.04
4771 19 0100	10	235	125	115	10	13.42
4771 19 0110	11	235	125	135	10	15.23
4771 19 0120	12	235	125	140	10	15.88
4771 19 0130	13	235	125	145	10	15.88
4771 19 0140	14	235	125	150	10	16.13

4771

Lokma Uçlu Tornavida Seti (8 Parça, mm)  
Nut Spinner Set (8 Pcs, mm)



KOD CODE	İÇERİK CONTENTS	g		TL/Ad.
4771 00 8108	6 - 7 - 8 - 9 - 10 11 - 12 - 13	950	1	109.20



4777

Torx® Uçlu Tornavida  
Torx® Driver

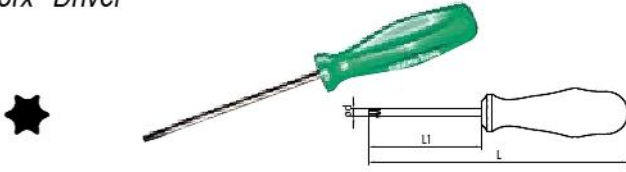

Krom vanadyum, Krom kaplı, PP saplı  
Chrom vanadium, Chrom plated and black tips, PP handle

KOD CODE	øDxL1 mm	★	L mm	g	□	TL/Ad.
4777 18 0010	4x80	T10	160	25	10	6.41
4777 18 0015	4x80	T15	160	30	10	6.52
4777 18 0020	4x100	T20	180	35	10	6.73
4777 18 0025	4.5x100	T25	190	45	10	7.13
4777 18 0027	5x100	T27	215	55	10	7.22
4777 18 0030	6x125	T30	225	75	10	7.77
4777 18 0040	7x125	T40	235	105	10	8.90
4777 18 0045	8x125	T45	235	120	10	10.60

4781

Manyetik Bits Tutucu Tornavida (Uzun)  
Screwdriver, Magnetic Bit Holder (Long)

TS 8748  
DIN 3126  
DIN 3127

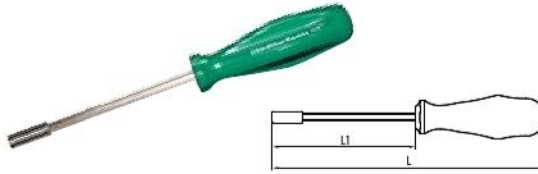

Krom vanadyum, Krom kaplı, PP saplı  
Chrom vanadium, Chrom plated PP handle

KOD CODE	ø mm	L mm	L1 mm	g	□	TL/Ad.
4781 19 6120	6.3	230	120	90	10	14.77

4786

Manyetik Bits Tutucu Tornavida (Kısa)  
Screwdriver, Magnetic Bit Holder, (Short)

TS 8748  
DIN 3126  
DIN 7427

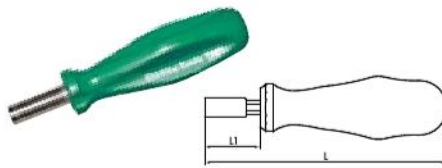

Krom vanadyum, Krom kaplı, PP saplı  
Chrom vanadium, Chrom plated PP handle

KOD CODE	ø mm	L mm	L1 mm	g	□	TL/Ad.
4786 19 6330	6.3	125	30	50	10	8.32

4811

Düz Bits  
Slotted Bit

TS 8748 • DIN 3127



Krom vanadyum  
Chrom vanadium

KOD CODE	ø	L mm	g	□	TL/Ad.
4811 20 0645	0.6x4.5	25	5	10	0.86
4811 20 0855	0.8x5.5	25	5	10	0.86
4811 20 1265	1.2x6.5	25	5	10	0.86

4811

Düz Bits  
Slotted Bit

TS 8748 • DIN 3127



Krom vanadyum  
Chrom vanadium

KOD CODE	ø	L mm	g	□	TL/Ad.
4811 20 5645	0.6x4.5	50	10	10	1.31
4811 20 5855	0.8x5.5	50	10	10	1.31
4811 20 5265	1.2x6.5	50	10	10	1.31

4821

Yıldız Bits  
Phillips Bit

TS 8748 • DIN 3128



Krom vanadyum  
Chrom vanadium

KOD CODE	+	L mm	g	□	TL/Ad.
4821 21 0001	Ph1	25	5	10	0.73
4821 21 0002	Ph2	25	5	10	0.73
4821 21 0003	Ph3	25	5	10	0.73

## DIY Elta Tools

### 4821

Yıldız Bits  
Phillips Bit

TS 8748 • DIN 3128



Krom vanadyum  
Chrom vanadium

KOD CODE	+	L mm	g	TL/Ad.
4821 21 0011	Ph1	50	10	10
4821 21 0012	Ph2	50	10	10
4821 21 0013	Ph3	50	10	10

### 4831

Torx® Bits  
Torx® Bit



Krom vanadyum  
Chrom vanadium

KOD CODE	*	L mm	g	TL/Ad.
4831 21 0025	T25	25	5	10
4831 21 0027	T27	25	5	10
4831 21 0030	T30	25	5	10
4831 21 0040	T40	25	5	10

### 4831

Torx® Bits  
Torx® Bit



Krom vanadyum  
Chrom vanadium

KOD CODE	*	L mm	g	TL/Ad.
4831 21 0125	T25	50	10	10
4831 21 0127	T27	50	10	10
4831 21 0130	T30	50	10	10
4831 21 0140	T40	50	10	10

### 4908

Allen Anahtar Altı Köşe (mm)  
Hex Key Wrench (mm)

TS ISO 2936



Krom vanadyum, Çinko kaplı  
Chrom vanadium, Zinc Plated

KOD CODE	mm	L mm	L1 mm	g	TL/Ad.
4908 22 0015	1.5	45	14	1.5	10
4908 22 0020	2	50	16	2	10
4908 22 0025	2.5	55	18	4	10
4908 22 0030	3	60	20	6	10
4908 22 0035	3.5	66	22	8	10
4908 22 0040	4	73	24	10	10
4908 22 0050	5	80	28	20	10
4908 22 0060	6	86	30	30	10
4908 22 0070	7	92	32	40	10
4908 22 0080	8	98	34	55	10
4908 22 0090	9	104	36	75	10
4908 22 0100	10	112	40	100	10
4908 22 0120	12	120	45	160	10
4908 22 0140	14	137	53	250	5
4908 22 0160	16	155	60	375	5
4908 22 0170	17	155	60	425	5
4908 22 0190	19	174	67	610	5

### 4908

Allen Anahtar Takım Altı Köşe (mm)  
Hex Key Wrench Set (mm)



KOD CODE	İÇERİK CONTENTS	g	TL/Ad.
4908 00 3107	1.5 - 2 - 2.5 - 3 - 4 - 5 - 6	80	7
4908 00 3109	1.5 - 2 - 2.5 - 3 - 4 5 - 6 - 8 - 10	235	9
4908 00 3110	1.5 - 2 - 2.5 - 3 - 4 - 5 6 - 8 - 10 - 12	395	10

**4911**

**Torx® Allen Anahtar**  
**Torx® Key Wrench**

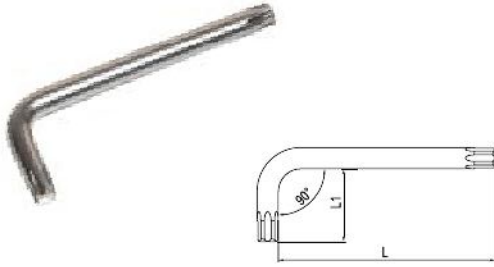

**Krom vanadyum, Çinko kaplı**  
**Chrom vanadium, Zinc Plated**

KOD CODE	★	L mm	L1 mm	g	□	TL/ Ad.
4911 22 0006	T6	42	16	2	10	4.16
4911 22 0007	T7	48	16	2	10	4.16
4911 22 0008	T8	48	16	3	10	4.16
4911 22 0009	T9	48	16	3	10	4.21
4911 22 0010	T10	51	17	4	10	4.21
4911 22 0015	T15	54	18	5	10	4.33
4911 22 0020	T20	57	19	5	10	4.54
4911 22 0025	T25	60	20	10	10	4.54
4911 22 0027	T27	64	21	15	10	4.54
4911 22 0030	T30	70	24	20	10	4.87
4911 22 0040	T40	76	26	30	10	5.16
4911 22 0045	T45	83	29	40	10	6.37
4911 22 0050	T50	95	32	60	10	7.26
4911 22 0055	T55	108	35	125	10	10.10
4911 22 0060	T60	120	38	185	10	13.93

**4911**

**Torx® Allen Anahtar Takımı (8 Parça)**  
**Torx® Key Wrench Set (8 Pcs)**



KOD CODE	İÇERİK CONTENTS	g	□	TL/Ad.
4911 00 7108	T9 - T10 - T15 T20 - T25 - T27 T30 - T40	155	8	36.40

**4915**

**Kaset Allen Anahtar Takımı (6 Parça, mm)**  
**Hex Key Wrench Folding Set (6 Pcs, mm)**



**Krom vanadyum, Siyah oksid kaplı**  
**Chrom vanadium, Black finish**

KOD CODE	İÇERİK CONTENTS	g	□	TL/Ad.
4915 00 6106	2.5 - 3 - 4 - 5 - 6 - 8	175	1	23.93

**4922**

**T Tipi Allen Anahtar (mm)**  
**Hex Key Wrench T - Handle (mm)**



**Krom vanadyum, Çinko kaplı, Ucu siyah oksit, PP saplı**  
**Chrom vanadium, Zinc plated and black tips, PP handle**

KOD CODE	mm	L mm	L1 mm	g	□	TL/ Ad.
4922 22 0025	2.5	110	14	15	5	8.25
4922 22 0030	3	125	18	20	5	8.32
4922 22 0040	4	140	22	30	5	8.40
4922 22 0050	5	155	26	55	5	9.57
4922 22 0060	6	170	30	75	5	10.48
4922 22 0070	7	185	34	115	5	10.84
4922 22 0080	8	200	38	150	5	13.09
4922 22 0100	10	220	48	270	5	22.88

**4922**

**T Tipi Allen Anahtar Takımı (8 Parça, mm)**  
**Hex Key Wrench T - Handle Set (8 Pcs, mm)**



KOD CODE	İÇERİK CONTENTS	g	□	TL/Ad.
4922 00 8108	2.5 - 3 - 4 - 5 6 - 7 - 8 - 10	730	8	91.83



## DIY Elta Tools

### 5011

Iskarpela (Düz)  
Wood Chisel



Özel alaşımli çelik, Uç indüksiyonda sertleştirilmiş, PP Saplı  
Special steel, induction hardened tips, PP Handle

KOD CODE	a mm	L mm	L1 mm	g	TL/Ad.	
5011 23 0006	6	275	155	105	5	10.45
5011 23 0008	8	275	155	125	5	10.45
5011 23 0010	10	275	155	140	5	10.45
5011 23 0012	12	275	155	140	5	10.45
5011 23 0014	14	275	155	145	5	12.06
5011 23 0016	16	275	155	165	5	12.06
5011 23 0018	18	275	155	165	5	12.06
5011 23 0020	20	275	155	165	5	12.71
5011 23 0022	22	275	155	180	5	12.71
5011 23 0024	24	275	155	205	5	13.26
5011 23 0026	26	275	155	205	5	13.26
5011 23 0028	28	275	155	205	5	14.50
5011 23 0030	30	275	155	205	5	14.50

### 5501

Düz Keski  
Flat Cold Chisel

TS 492  
DIN 6450

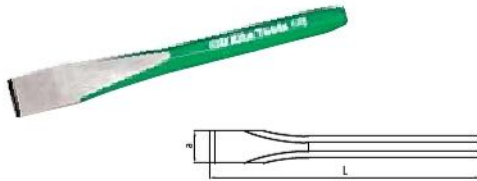

Özel alaşımli çelik, Elektrostatik boyanmış  
Special steel, Electrostatically painted

KOD CODE	L mm	a	mm	g	TL/Ad.	
5501 23 0100	100	10	10	50	5	6.05
5501 23 0125	125	10	10	70	5	6.73
5501 23 0150	150	14	12	140	5	7.33
5501 23 0175	175	18	12	170	5	8.00
5501 23 0200	200	20	16	295	5	9.27
5501 23 0250	250	22	16	370	5	10.60
5501 23 0300	300	24	20	645	5	14.83

### 5521

Tırnak Keski  
Cross Cut Chisel

TS 492/1  
DIN 6450



Krom vanadyum, Elektrostatik boyanmış  
Chrom vanadium, Electrostatically painted

KOD CODE	L mm	a mm	mm	g	TL/Ad.	
5521 23 0125	125	5	10	70	10	12.21
5521 23 0150	150	6	12	110	10	13.24

### 5541

Nokta Zımba  
Center Punch

TS 2338 • DIN 7250



Krom vanadyum, Elektrostatik boyanmış  
Chrom vanadium, Electrostatically painted

KOD CODE	L mm	L inch	σD mm	mm	g	TL/Ad.	
5541 24 4120	120	4 3/4"	4	10	60	10	6.76
5541 24 5150	150	6"	5	12	120	10	7.72

### 5546

Konik Pim Zımba  
Drift Punch

TS 2338 • DIN 6458



Krom vanadyum, Elektrostatik boyanmış  
Chrom vanadium, Electrostatically painted

KOD CODE	L mm	L inch	σD mm	mm	g	TL/Ad.	
5546 24 0002	120	4 3/4"	2	10	55	10	6.76
5546 24 0003	120	4 3/4"	3	10	60	10	6.76
5546 24 0004	120	4 3/4"	4	10	60	10	6.76
5546 24 0005	120	4 3/4"	5	10	65	10	6.76
5546 24 0006	120	4 3/4"	6	10	65	10	6.76
5546 24 0007	120	4 3/4"	7	12	100	10	7.76
5546 24 0008	120	4 3/4"	8	12	100	10	7.76
5546 24 0009	120	4 3/4"	9	12	105	10	8.54
5546 24 0010	120	4 3/4"	10	12	105	10	8.54

**5551**

**Düz Pim Zımba**  
*Split Pin Punch*

TS 2338 • DIN 6450

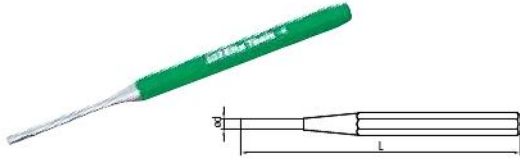

**Krom vanadyum, Elektrostatik boyanmış**  
*Chrom vanadium, Electrostatically painted*

KOD CODE	L mm	øD mm	g	TL/Ad.	
5551 24 0002	115	2	30	5	8.14
5551 24 0003	125	3	45	5	8.14
5551 24 0004	150	4	60	5	8.14
5551 24 0005	160	5	80	5	8.14
5551 24 0006	180	6	125	5	8.14
5551 24 0008	200	8	155	5	8.14
5551 24 0010	215	10	190	5	11.40

**5701**

**Kayış Zımba**  
*Belt Punch*

**TSEK**  
DIN 7200

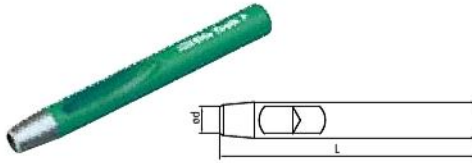

**Krom vanadyum, Elektrostatik boyanmış**  
*Chrom vanadium, Electrostatically painted*

KOD CODE	ØD mm	L mm	g	TL/Ad.	
5701 24 0003	3	105	35	10	7.17
5701 24 0004	4	105	45	10	7.51
5701 24 0005	5	110	55	10	8.18
5701 24 0006	6	110	60	10	8.31
5701 24 0007	7	115	70	10	9.16
5701 24 0008	8	115	80	10	9.75
5701 24 0009	9	120	100	10	10.88
5701 24 0010	10	120	115	10	11.60
5701 24 0011	11	125	130	5	12.45
5701 24 0012	12	125	145	5	14.93
5701 24 0013	13	130	160	5	15.70
5701 24 0014	14	130	170	5	17.25
5701 24 0015	15	135	250	5	19.80
5701 24 0016	16	135	300	5	21.70
5701 24 0017	17	140	345	5	23.73
5701 24 0018	18	140	365	5	25.89
5701 24 0019	19	145	410	5	28.16
5701 24 0020	20	145	440	5	29.97

**5701**

**Kayış Zımba Takımı**  
*Belt Punch Set*



KOD CODE	İÇERİK CONTENTS	g	TL/Ad.	
5701 00 2112	3 - 4 - 5 - 6 - 7 - 8 - 9 10 - 11 - 12 - 13 - 14	1130	12	132.89

**5801**

**Tesviyeci Çekiç**  
*Machinist's Hammer*

TS 5 • DIN 1041

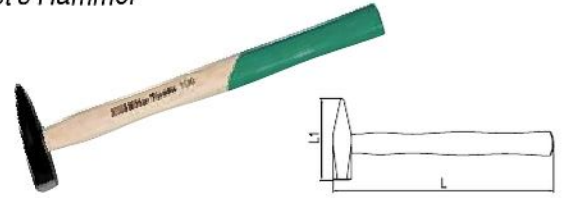

**Özel alaşımli çelik, İndüksiyonda sertleştirilmiş**  
*Special steel, Induction hardened*

KOD CODE	L mm	L1 mm	g	g	TL/Ad.	
5801 25 0100	260	82	100	145	10	6.45
5801 25 0200	280	95	200	245	10	8.37
5801 25 0300	300	105	300	390	10	9.93
5801 25 0500	320	118	500	565	5	12.42
5801 25 1000	360	135	1000	1145	5	19.62
5801 25 1500	380	145	1500	1615	5	24.84
5801 25 2000	400	150	2000	2300	5	28.77

**5851**

**Plastik Çekiç**  
*Plastic Hammer*

TS 5

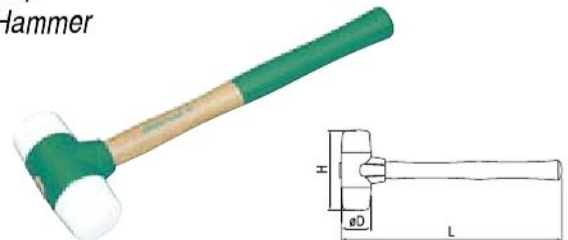

**Darbeye dayanıklı, kolay değiştirilebilir selüloz asetat başlık**  
*Made from cellulose acetate, Durable and easily changeable heads*

KOD CODE	L mm	øD mm	H mm	g	TL/Ad.	
5851 25 0030	300	30	100	335	5	23.38
5851 25 0040	320	40	110	595	5	30.86
5851 25 0050	350	50	120	1030	5	37.62

## DIY Elta Tools

**5851**

Başlık  
Head

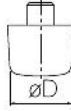

KOD CODE	ØD mm	g	□	TL/Ad.
5851 25 0130	30	35	10	5.39
5851 25 0140	40	70	10	7.75
5851 25 0150	50	125	10	11.14

**5884**

Plastik Şerit Metre  
Plastic Measuring tapes

TS 9505



KOD CODE	ÖLÇÜ SIZE	g	□	TL/Ad.
5884 26 0002	2	85	5	4.06
5884 26 0003	3	95	5	5.33
5884 26 0005	5	195	5	8.62

**5891**

Testere Kolu  
Hacksaw Frame

DIN 6473



KOD CODE	L mm	g	□	TL/Ad.
5891 26 0830	300	345	5	10.64

**6196**

Perçin Tabancası  
Riveting Pliers



KOD CODE	ÖLÇÜ SIZE	CAPACITY mm	g	□	TL/Ad.
6196 26 0260	260	2.5 - 3.2 - 4 - 4.8	545	1	35.40

**6231**

Gres Pompası  
Grease Gun



KOD CODE	ÖLÇÜ SIZE cc	g	□	TL/Ad.
6231 26 0500	500	1300	1	24.51

**6351**

Levye Oluklu  
Tyre Lever, Straight

TSEK



Krom vanadyum, Krom kaplı  
Chrom vanadium, Chrom plated

KOD CODE	L mm	L inch	g	□	TL/Ad.
6351 26 0400	400	16"	435	5	14.23
6351 26 0500	500	20"	680	5	16.89
6351 26 0600	600	24"	970	5	24.04

**7411**

Sıralı Tel Fırça (Ağaç Saplı)  
Hand Brush (Wooden Handle)



KOD CODE	ÖLÇÜ SIZE	g	□	TL/Ad.	
7411 26 0003	3 SIRA	3 RAWS	130	5	2.92
7411 26 0004	4 SIRA	4 RAWS	145	5	3.07
7411 26 0005	5 SIRA	5 RAWS	150	5	3.44
7411 26 0006	6 SIRA	6 RAWS	175	5	3.71

**7412**

Kıvrık Uçlu Fırça (Plastik Saplı)  
Hand Brush (PP Handle)



KOD CODE	ÖLÇÜ SIZE	g	□	TL/Ad.
7412 26 0270	250	110	5	2.86

6721

Bağ Makası (Lüks)  
Pruning Shears (Lux)

TS 3306



Özel alaşımli çelik, Kesici ağızlar indüksiyonda sertleştirilmiş, Daldırma PVC izoleli  
Special steel, Cutters induction hardened, PVC dipped

KOD CODE	L mm	L inch	g	TL/Ad.
6721 27 0205	205	8'	290	5 18.68

6722

Bağ Makası (Hafif Tip)  
Pruning Shears (Light)



Alüminyum gövde, Daldırma PVC izoleli  
Aluminum forged body, PVC dipped

KOD CODE	L mm	L inch	g	TL/Ad.
6722 27 0220	220	8 5/8'	240	5 21.50

6730

Çim Kesme Makası (Düz Ağız)  
Grass Shears (Straight)



KOD CODE	L mm	L inch	g	TL/Ad.
6730 27 0550	550	21 5/8'	915	5 25.70

6731

Çim Kesme Makası (Eğri Ağız)  
Grass Shears (Wave Edges)



KOD CODE	L mm	L inch	g	TL/Ad.
6731 27 0650	650	25 5/8'	1195	5 48.31

7011

Standart Çektirme (iki Kollu)  
Standard Puller (Two Arms)

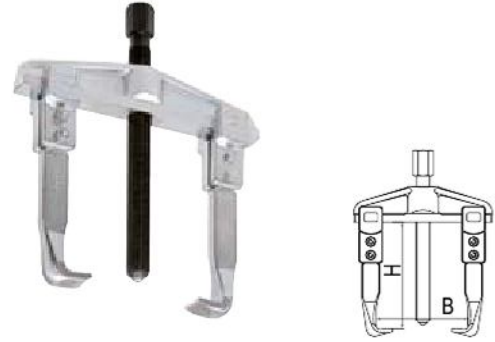

Krom vanadyum, Çinko kaplı, Kollar sertleştirilmiş,  
Mil indüksiyonda sertleştirilmiş  
Chrom vanadium, Zinc plated,  
Arms hardened, Spindle induction hardened

KOD CODE	B mm	H mm	g	TL/Ad.
7011 29 0810	8x10	80	100	1080 1 113.58
7011 29 1210	12x10	120	100	1235 1 121.47
7011 29 1615	16x15	160	150	2910 1 207.12
7011 29 2015	20x15	200	150	3060 1 226.57
7011 29 2520	25x20	250	200	7470 1 391.33



## DIY Elta Tools

8011

Teşhir Panosu  
Display



Sacdan imal edilmiş, Fırın boya  
Made from metal sheet, Electrostatic paint

KOD CODE	SIZE mm	g		TL/Ad.
8011 31 6001	500x1000x2250	14000	1	542.27

8230

Servis Dolabı (5 Çekmeceli)  
Workshop Trolley (5 Drawers)



Sacdan imal edilmiş, Fırın boya  
Made from metal sheet, Electrostatic paint

KOD CODE	SIZE ÖLÇÜ mm	g		TL/Ad.
8230 32 6001	390x670x920	55000	1	830.00
8230 00 6058	DOLU / FULL		1	1448.59

8230 00 6001

İki Ağız Anahtar Seti  
Double Ended Open Jaw Wrench Set



KOD CODE	İÇERİK CONTENTS		TL/Ad.
8230 00 6001	0150 İki Ağız Anahtar/ D/E Open Jaw Wrench 6x7 - 8x9 - 10x11 - 12x13 - 14x15 - 16x17 18x19 - 20x22 - 21x23 - 24x26	1	50.53

8230 00 6002

Kombine Anahtar Seti  
Combination Wrench Set



KOD CODE	İÇERİK CONTENTS		TL/Ad.
8230 00 6002	0350 Kombine Anahtar/ Combination Wrench Set 6 - 7 - 8 - 9 - 10 - 11 - 12 13 - 14 - 17 - 19 - 22	1	83.14

8230 00 6003

Yıldız Anahtar Seti  
Double Ended Ring Wrench Set



KOD CODE	İÇERİK CONTENTS		TL/Ad.
8230 00 6003	0450 Yıldız Anahtar/ D/E Ring Wrench Set 6x7 - 8x9 - 10x11 - 12x13 14x15 - 16x17 - 18x19 - 20x22	1	82.33

**8230 00 6004**



KOD CODE	İÇERİK CONTENTS	☐	TL/Ad.
8230 00 6004	4771 Lokma Tornavidalar/ Nut Spinner Set 6 - 7 - 8 - 9 - 10 - 14	1	78.34

**8230 00 6005**



KOD CODE	İÇERİK CONTENTS	☐	TL/Ad.
8230 00 6005	4x100 - 5x125 6x150 - 8x175 4150 Düz uçlu/Flat 4.5x80 - 6x100 4170 Yıldız uçlu/Phillips	1	42.39

**8230 00 6006**



KOD CODE	İÇERİK CONTENTS	☐	TL/Ad.
8230 00 6006	5501 150 mm Düz Keski/Flat Cold Chisel 5541 4x120 mm Nokta Zimba/Center Punch 5546 5mm Konik Pim Zimba/Drift Punch 5551 5mm Düz Pim Zimba/Split Pin Punch 5801 300 gr Tesviyeci Çekiç/Machinists Hammer 5851 30mm Plastik Çekiç/Plastic Hammer	1	62.30

**8230 00 6007**



KOD CODE	İÇERİK CONTENTS	☐	TL/Ad.
8230 00 6007	0601 10" Kurbağacık/Adjustable Wrench 2401 240mm Special Fort Pense/ Waterpump Pliers Special 2509 225mm Special Ayarlı Pense/Special Grip	1	57.48

**8230 00 6008**



KOD CODE	İÇERİK CONTENTS	☐	TL/Ad.
8230 00 6008	3021 180mm Kombine Pense/Combination Pliers 3701 160mm Yan Keski/Side Cutting Pliers 3221 200mm Kargaburun/Long Nose Pliers (Flat)	1	46.82

**8230 00 6009**



KOD CODE	İÇERİK CONTENTS	☐	TL/Ad.
8230 00 6009	3303 180mm Dış Seg. Pen. Yaylı Düz/ Circlip Pliers, External (Flat) 3304 170mm Dış Seg. Pen. Yaylı Eğri/ Circlip Pliers, External (Bent) 3323 180mm İç Seg. Pen. Yaysız Düz/ Circlip Pliers Internal (Flat) 3324 170mm İç Seg. Pen. Yaysız Eğri/ Circlip Pliers Internal (Bent)	1	115.26

## DIY Elta Tools

8411

Takım Çantası (Üç Gözlü)  
Tool Box (Three Trays)

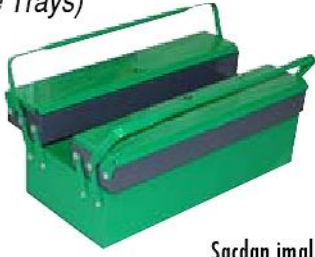

Sacdan imal edilmiş, Fırın boyalı  
Made from metal sheet, Electrostatic paint

KOD CODE	ÖLÇÜ SIZE mm	g	TL/Ad.
8411 33 6103	190x420x150	3000	1 48.72
8411 33 6203	190x520x150	3600	1 53.60

8421

Takım Çantası (Beş Gözlü)  
Tool Box (Five Trays)

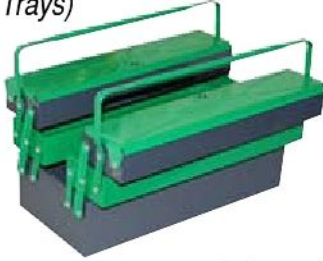

Sacdan imal edilmiş, Fırın boyalı  
Made from metal sheet, Electrostatic paint

KOD CODE	ÖLÇÜ SIZE mm	g	TL/Ad.
8421 33 6105	190x420x200	4200	1 56.50
8421 33 6205	190x520x200	5000	1 62.15

8719 00 4108

Poşet Oto Tipi (8 Parça)  
Pouch For Auto (8 pcs)



KOD CODE	İÇERİK CONTENTS	TL/Ad.
8719 00 4108	0150 İki Ağız Anahtar D/E Open Jaw Wrench 10x11-12x13-14x15-16x17-18x19-20x22 3021 160mm Kombine Pense Combination Pliers 4170 6x80 Değişken Uçlu Tornavida/ Screwdriver Reversible	1 50.84

8745 00 8104

Okul Seti (4 Parça)  
Set For School (4 pcs)



KOD CODE	İÇERİK CONTENTS	TL/Ad.
8745 00 8104	3021 160mm Kombine Pense 160mm Combination Pliers 3701 160mm Yan Keski 160mm Side Cutting Pliers 4170 6x80 Değişken Uçlu Tornavida 6x80 Screwdriver Reversible 5801 100gr Tesviyeci Çekiç 100gr Machinists Hammer	1 41.58

8746 00 8105

Okul Seti (5 Parça)  
Set For School (5 pcs)



KOD CODE	İÇERİK CONTENTS	TL/Ad.
8746 00 8105	3021 160mm Kombine Pense Combination Pliers 160mm Yan Keski/ Side Cutting Pliers 3221 160mm Uzun Kargaburun Düz/ Long Nose Pliers (Flat) 4170 6x80 Değişken Uçlu Tornavida Screwdriver Reversible 5801 100gr Tesviyeci Çekiç Machinists Hammer	1 55.96



**8772 00 8103**

**Poşet Ev Tipi (3 Parça)**  
*Set For Home (3 pcs)*



KOD CODE	İÇERİK CONTENTS	☐	TL/Ad.
8772 00 8103	3021 160mm Kombine Pense/ Combination Pliers 3221 160mm Uzun Kargaburun Düz/ Long Nose Pliers (Flat) 4170 6x80 Değişken Uçlu Tornavida/Screwdriver Reversible	1	35.39

**8773 00 8103**

**Hobby Set Ev Tipi (3 Parça)**  
*Hobby Set For Home (3 pcs)*



KOD CODE	İÇERİK CONTENTS	☐	TL/Ad.
8773 00 8103	3021 160mm Kombine Pense/ Combination Pliers 4170 6x80 Değişken Uçlu Tornavida/Screwdriver Reversible 5801 100gr Tesviyeci Çekiç/ Machinists Hammer	1	27.46

**8980 - 8981**

**Anahtar Sehpası**  
*Display Frame For Wrenches*



*Sacdan imal edilmiş, Fırın boyalı*  
*Made from metal sheet, Electrostatic paint*

KOD CODE	ÖLÇÜ SIZE mm	g	☐	İÇERİK CONTENTS	TL/ Ad.
8980 31 6012	430x165	825	1	Çatal Anh. sehpası Boş	15.50
8981 31 6012	540x200	1130	1	Yıldız Anh. sehpası Boş	16.82

**8982**

**Kurbağacak Anahtar Sehpası**  
*Display Frame For Adjustable Wrench*



KOD CODE	İÇERİK CONTENTS	g	☐	TL/Ad.
8982 31 6029	Boş - Empty	2000	1	26.24

**8983**

**1/2" Lokma Anahtar Sehpası**  
*Display Frame for Sockets*



**1/2"**

*Sacdan imal edilmiş, Fırın boyalı*  
*Made from metal sheet, Electrostatic paint*

KOD CODE	g	☐	TL/Ad.
8983 31 6100	4960	1	58.82

**8984**

**Tornavida Sehpası**  
*Display Frame For Screwdrivers*



*Sacdan imal edilmiş, Fırın boyalı*  
*Made from metal sheet, Electrostatic paint*

KOD CODE	İÇERİK CONTENTS	g	☐	TL/Ad.
8984 31 6070	Boş / Empty	2000	1	45.58



## DIY Elta Tools

8985

Tekerlekli Üçgen Teşhir Standı  
Triangular Display Frame With Wheels



Sacdan imal edilmiş, Fırın boya  
Made from metal sheet, Electrostatic paint

KOD CODE	ÖLÇÜ SIZE mm	g	TL/Ad.
8985 31 6001	520x1600	24000	1 208.97

8986

Tekerlekli Teşhir Panosu  
Display Frame With Wheels



Sacdan imal edilmiş, Fırın boya  
Made from metal sheet, Electrostatic paint

KOD CODE	ÖLÇÜ SIZE mm	g	TL/Ad.
8986 31 6001	525x700x1750	13000	1 191.76

8990

Servis Arabası  
Tool Trolley



Çelik konstrüksiyon  
Steel construction

KOD CODE	ÖLÇÜ SIZE mm	g	TL/Ad.
8990 34 6101	500x850x960	50000	1 350.00

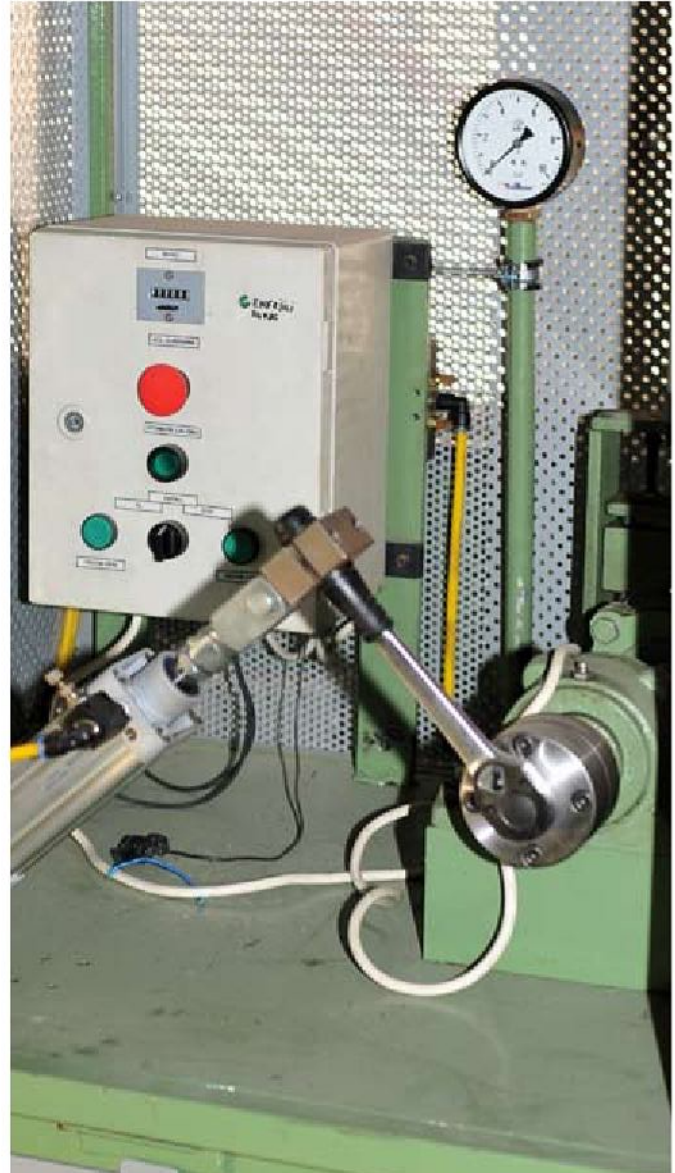

# ***Havalı Aletler Grubu***

*Havalı Somun Sıkma*

*Impact Wrench*

*Havalı Cırcır*

*Ratchet Wrench*

*Havalı Kalıpcı Taşlama*

*Die Grinder*



# *Elta Tools*



**7601**

1/2" Havalı Somun Sıkma  
Impact Wrench



**7631**

3/4" Havalı Somun Sıkma  
Impact Wrench



**1/2"**

Çift Çekiçli, Alüminyum Gövde  
Twin hammer, Aluminium body

KOD CODE	Max. Tork Nm	Civata Ölçüsü	Yüksüz Devir rpm	g	TL/Ad.
7601 35 0250	740	M16	7500	2670	1 360.00

**3/4"**

Çift Çekiçli, Alüminyum Gövde  
Twin hammer, Aluminium body

KOD CODE	Max. Tork Nm	Civata Ölçüsü	Yüksüz Devir rpm	g	TL/Ad.
7631 35 0350	740	M25	7500	2700	1 390.00

**7611**

1/2" Havalı Somun Sıkma  
Impact Wrench



**7641**

3/4" Havalı Somun Sıkma  
Impact Wrench



**1/2"**

Çift Çekiçli, Kompozit Gövde  
Twin hammer, Composite body

KOD CODE	Max. Tork Nm	Civata Ölçüsü	Yüksüz Devir rpm	g	TL/Ad.
7611 35 0260	690	M16	8500	1940	1 372.00

**3/4"**

Çift Çekiçli, Alüminyum Gövde  
Twin hammer, Aluminium body

KOD CODE	Max. Tork Nm	Civata Ölçüsü	Yüksüz Devir rpm	g	TL/Ad.
7641 35 3110	1490	M30	5500	5150	1 750.00

## DIY Elta Tools

7661

1" Havalı Somun Sıkma  
Impact Wrench



1"

Çift Çekiçli, Alüminyum Gövde  
Twin hammer, Aluminium body

KOD CODE	Max. Tork Nm	Civata Ölçüsü	Yüksüz Devir rpm	g	TL/Ad.
7661 35 4110	1490	M32	5500	6060	1 805.00

7671

1" Havalı Somun Sıkma  
Impact Wrench



1"

Çift Çekiçli, Alüminyum Gövde  
Twin hammer, Aluminium body

KOD CODE	Max. Tork Nm	Civata Ölçüsü	Yüksüz Devir rpm	g	TL/Ad.
7671 35 4165	2169	M33	4500	8500	1 1320.00

7681

1/2" Havalı Cıracı  
Ratchet Wrench



1/2"

Alüminyum Gövde, Çelik Mekanizma  
Aluminium body, Steel mechanism

KOD CODE	Max. Tork Nm	Civata Ölçüsü	Yüksüz Devir rpm	g	TL/Ad.
7681 35 0207	95	M12	160	1300	1 189.00

7691

Havalı Kalıpcı Taşlama  
Die Grinder



Alüminyum Gövde, Çelik Mekanizma  
Aluminium body, Steel mechanism

KOD CODE	Sap Çapı mm	Çıkış Gücü w	Yüksüz Devir rpm	g	TL/Ad.
7691 35 0210	3 - 6	320	20000	550	1 130.00

**Risk almayın, tedbir alın**

Elta El Aletleri, işinizi daha da kolaylaştırmak için her zaman yanınızda olan, özel olarak tasarlanmış en iyi iş arkadaşlarınız. Gelin, onları iş güvenliği kurallarına uyarak, alınacak tedbirleri ihmal etmeyerek kullanalım, sağlığımızı tehlikeye atmayalım.

**Don't take risk, just take the necessary measures**

*Elta Hand Tools are your best work-friends, specially designed for facilitating your job. Let's use them taking care of the necessary measures without endangering our lives.*



İşin türüne göre gereken koruyucuları kullanınız.

*Use necessary protection equipment according to the specification of the job.*



Sıkma ve sökme işlemi daima çekerek yapılmalı.

*Tightening and extracting applications must always done by pulling.*



Tornavidanızı keski, punta veya levye yerine kesinlikle kullanmayınız.

*Do not use a screwdriver as a chisel or lever.*



Kesme için uç yerine mafsala yakın yeri kullanınız. Somun ve civata üzerinde kullanmayınız. Çekiç gibi kullanmayınız. Ayarlı (kilitlenebilir) penseleri uzun süre kilittli bırakmayınız, asla basamak gibi kullanmayınız, elemanlar oynayabilir. Asla orijinali bozmayınız.

*Use the throat rather than tip of cutting edge. Do not use on bolts and nuts. Do not use like a hammer. Grip pliers should not be used as a pemanent clamp, parts can move. Do not modify products.*



Eşit sertlikteki veya daha sert yüzeylere çekiçle vurmaktan sakınınız. Çekiğin çarpma yüzeyinin vurulan alandan geniş olmasına özen gösteriniz (Çekiç kafasının çapı vurulan yüzeyden yaklaşık 10 mm daha geniş olmalıdır). Arızalı, gevşek veya çatlak çekiçleri kesinlikle kullanmayınız.

*Never hit on hards surfaces. A hammer should have a diameter approx. 10 mm larger than the surface to hit. Do not use loose, cracked head hammers.*

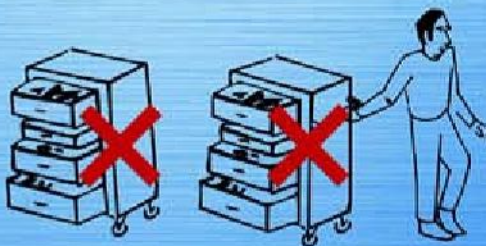

Sabit kullanımda birden fazla çekmece açmayınız.

Hareket halinde bütün çekmeceler ve kapılar kapalı olmalı ve üzerinde bir şey bulunmamalıdır.

*Do not open more than one drawer during your usage. While moving the trolley, drawers must be locked.*

# OTOMOTİV SEKTÖRÜNDE ELTA İLE KALİTELİ ve EKONOMİK ÇÖZÜMLER

ELTA 5 ÇEKMECELİ SERVİS DOLABI



## **DIY Elta Tools**

Kemalpaşa Caddesi No:41 Işıkkent İzmir - TÜRKİYE

**İNTERNET ADRESİMİZ /WEB**

[www.eltaaletleri.com.tr](http://www.eltaaletleri.com.tr) [info@eltaaletleri.com.tr](mailto:info@eltaaletleri.com.tr)

**SİPARİŞ TEL /PHONE FOR ORDERS**

Direkt: +90.232 472 13 92

Santral Tel: +90.232 472 13 75

Fax: +90.232 472 13 78

**ANKARA İRTİBAT BÜROMUZ:**

**ANKARA OFFICE:**

Ahi Evran Cad.

İş Geliştirme Mrk. Binası 18/1 D:9-10

Ostım - ANKARA

Tel: +90.312 385 24 83

385 24 28

Fax: +90.312 385 04 13

**İSTANBUL İRTİBATBÜROMUZ:**

**İSTANBUL OFFICE:**

Perpa Ticaret Merkezi

No.988 K.7 P.K:80270

Okmeydanı - İSTANBUL

Tel: +90.212 220 05 69

220 84 04 - 221 74 50

Fax: +90.212 221 74 51

**İZELTAŞ İzmir tesislerinde üretilmiştir.**