



Konuşulan Kalite
The Spoken Quality

KESİCİ UÇ BAĞLAMA SİSTEMLERİ
CONNECTION SYSTEMS FOR CUTTING INSERTS



TS EN ISO 9001:2008





Konuşulan **kalite...**
The Spoken Quality



www.akkocom.tr



1986 yılında Abdullah KARAKUŞ tarafından kurulan AKKO Oto. Mak. Hird. San. Tic. Ltd. Şti. olarak Tornalama Takımlarını, Diş ve Kanal Açma Takımlarını, Delik Delme Takımlarını, Frezeleme Takımlarını ve Özel Takımları üretmekteyiz. 90 m² lik bir torna atölyesinde Konya sanayisine merhaba demiştik. Şu an 8000 m² ye yakın bir alanda Türkiye, Japonya, Almanya, İsveç gibi ülkelerin ürettikleri son teknoloji tezgah ve ekipmanlarımızla yıllık 180.000 adet üretim kapasitemizle, standart 3000 çeşit takım üretimi yapmaktayız. Müşterilerimize “yok” satmamak için 100.000 adet civarında üretilmiş ürün stoklarımızda mevcuttur. Fabrikamıza, özel ürettirdiğimiz çelik hammadde girer ve bütün üretim süreci bünyemizde gerçekleşir. Çeliğin işlenmesinden tutunda ısı işlemine, üzerindeki kaplamaya varıncaya kadar her türlü işlem bir entegre tesis olan AKKO’da gerçekleşir.

Avrupa Ülkeleri, Asya Ülkeleri, Afrika, Güney Amerika Ülkeleri ve Orta Doğu Ülkeleri olmak üzere şimdilik 55 tane ülkeye mal sevkiyatına devam etmekteyiz. Global krize aldırış etmeden kısa, orta ve uzun vadeli yatırım planlarını gerçekleştirerek sektörün en iyisi olma yolunda ilerlemekteyiz. Kesici Takım sektöründe “Konuşulan Kalite” sloganıyla tercih edilen firma haline gelmekten onur duyuyoruz. Takımlarımızı kullanan firmaların tescillediği kalitemizi, Türk Standartları Enstitüsü de tescilleyerek TS EN ISO 9001:2008 Kalite Yönetim Sistemi Belgesini bize, vermeyi uygun bulmuştur.

Kuruluşumuzdan bu yana müşteri odaklı bir organizasyon yapısına sahip olan firmamız, müşterileri ile arasındaki diyalogu daha da geliştirerek onlara, deneyimli ve yetenekli kadrosuyla teknik bilgi aktarımını devam ettirmekten kıvanç duyar. Talaşlı imalat yapan bütün firmalara hizmet etmek en büyük mutluluğumuzdur. Herşey, en iyiye ve en kaliteliye layık olan müşterilerimiz içindir.

We as AKKO Oto. Mak. Hird. San. Tic. Ltd. Şti, which has been founded by Abdullah KARAKUŞ in 1986, produce Turning Tool Holders, Threading and Grooving Tool Holders, U-Drills, Milling Tool Holders and Precision Tool Holders (OEM Tool Holders). We said hello to Konya Industry in 90 square meter atelier. Now, we produce standard 3000 kinds of tool holders with production capacity of 180.000 pieces per annum in an area about 8000 square meter with latest technology lathes and equipments that are produced by countries like Turkey, Japan, Germany, Sweden. We keep ready about 100.000 pieces produced products in our stock to meet request of our customers immediately without saying them we have nothing for sale. Steel Raw materials that we make produced especially for us are delivered our factory and all production process are made in our factory. All kind of process from machining of steel to heat treatment and coating on our tools are made in our integrated factory AKKO.

For present, we are going on exporting 55 countries including European countries, Asian Countries, African Countries, Asian Countries, South American Countries and Middle East Countries. We are proceeding on the way of being the best of the sector by realizing short-term, medium-term and long-term investment plans without caring Global Recession. We are proud of becoming preferred firm with “Spoken Quality” slogan in Cutting Tool sector. Our Quality, which has been registered by the companies that use our Tool holders, also has been registered by Turkish Standards Institution by approving to give us TS EN ISO 9001:2008 Quality Management System.

Our firm which has customer-focused organization structure since its inception, is pleased to continue transferring know-how to its customers with its experienced and talented permanent staffs by developing its dialogs more between its customers. Our greatest hapiness is serving all companies that makes machining. Everything is for our customers who deserve the optimum and the highest quality products.

Abdullah KARAKUŞ
Genel Müdür
General Manager

DIŞ ÇAP TORNA TAKIMLARI

- S3 Dış Çap Torna Katerleri Kodlama Sistemi
- S4-S12 T- Sistem Dış Torna Katerleri
- S13-S15 M- Sistem Dış Torna Katerleri
- S16-S27 S- Sistem Dış Torna Katerleri
- S28-S35 P- Sistem Dış Torna Katerleri
- S36-S40 C- Sistem Dış Torna Katerleri

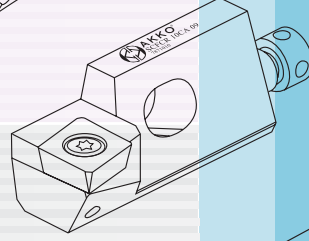
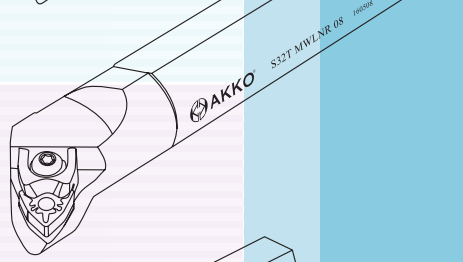
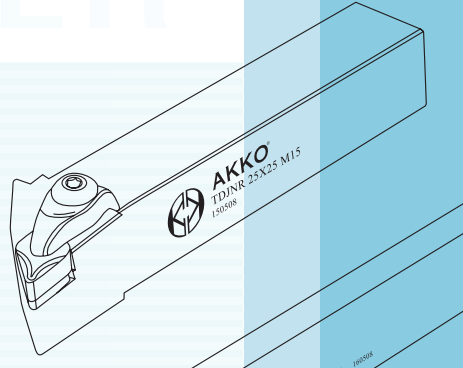

DELİK TORNA TAKIMLARI

- S42 Delik Torna Katerleri Kodlama Sistemi
- S43-S48 T&C Sistem Delik Torna Katerleri
- S49-S54 M- Sistem Delik Torna Katerleri
- S55-S65 S- Sistem Delik Torna Katerleri
- S66-S70 P- Sistem Delik Torna Katerleri

KARTUŞLAR

- S72 Kartuşlar Kodlama Sistemi
- S73-S77 Kartuşlar

DIŞ ve KANAL AÇMA TAKIMLARI

- S79 Dış Açma Katerleri Kodlama Sistemi
- S80 Dış Çap Dış Açma Takımları
- S81 Delik İçi Dış Açma Takımları
- S83 Kanal Açma Takımları Kodlama Sistemi
- S84-S91 Dış Çap Kanal Açma Takımları
- S92-S94 Dış Çap Alın Kanal Açma Takımları
- S95-S97 Delik İçi Kanal Açma Takımları

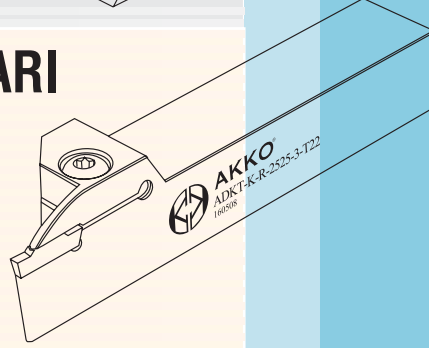

DELİK DELME TAKIMLARI

- S99 Takma Uçlu Matkaplar Kodlama Sistemi
- S100-S112 Takma Uçlu Matkaplar

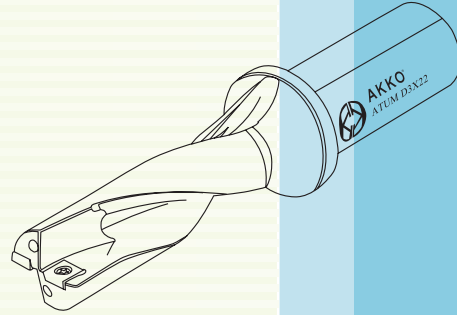

FREZELEME TAKIMLARI

- S114 Frezeleme Takımları Kodlama Sistemi
- S115-S122 S-Sistem Parmak Frezeler
- S123-S124 S-Sistem Modüler Parmak Frezeler
- S125 Küre Uçlu Parmak Frezeler
- S126 S-Sistem Helis Frezeler
- S127 S-Sistem Pah Frezeler
- S129-S139 Yüzey ve Kopya Frezeler
- S140 Hızlı İlerlemeli Takımlar
- S141 Disk Frezeler
- S142 T Kanal Frezeler
- S143 Takma Uçlu Matkaplar (U-drill) Teknik Bilgileri
- S144 Frezeleme Takımları Teknik Bilgileri
- S145 Frezeleme Takımları Montaj Ölçüleri
- S146-S153 Yedek Parçalar

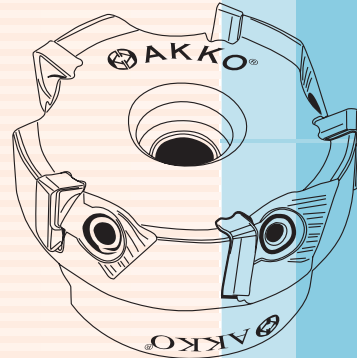

CONTENTS

CONTENTS

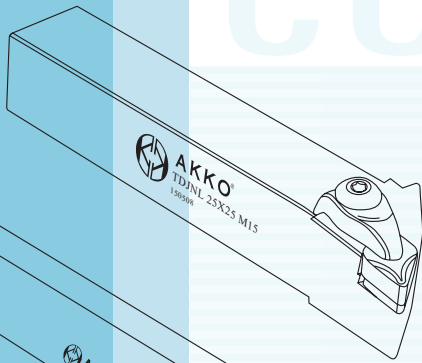

EXTERNAL TURNING TOOLHOLDERS

- P3 External Turning Toolholders Designation System
- P4-P12 T- System External Turning Toolholders
- P13-P15 M-System External Turning Toolholders
- P16-P27 S- System External Turning Toolholders
- P28-P35 P- System External Turning Toolholders
- P36-P40 C- System External Turning Toolholders

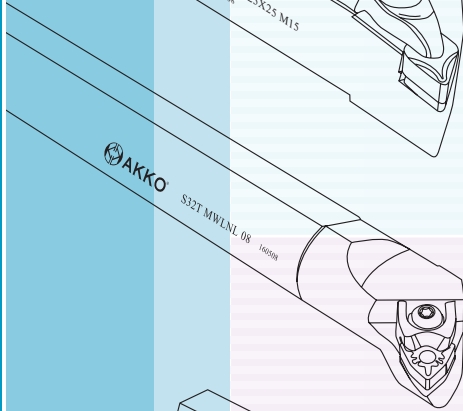

SYSTEM BORING BARS

- P42 Internal Turning Toolholders Designation System
- P43-P48 T&C System Boring Bars
- P49-P54 M- System Boring Bars
- P55-P65 S- System Boring Bars
- P66-P70 P- System Boring Bars

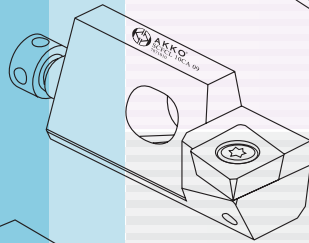

CARTRIDGE

- P72 Cartridge Designation System
- P73-S77 Cartridge

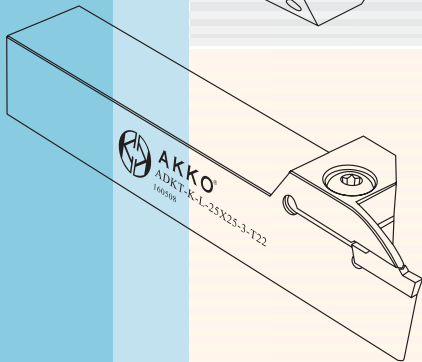

THREADING and GROOVING TOOLHOLDERS

- P79 Threading Toolholders Designation System
- P80 External Threading Toolholders
- P81 Internal Threading Toolholders
- P83 Grooving Toolholders Designation System
- P84-P91 External Grooving Toolholders
- P92-P94 Face External Grooving Toolholders
- P95-P97 Internal Grooving Toolholders

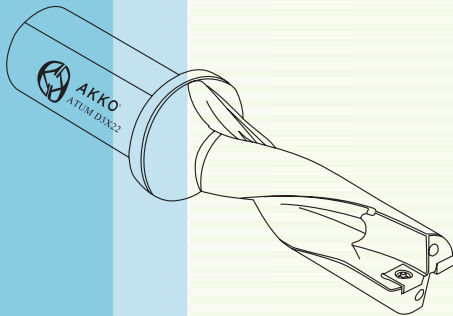

DRILLING TOOLHOLDERS

- P99 U-drill Designation System
- P100-P112 U-drill System

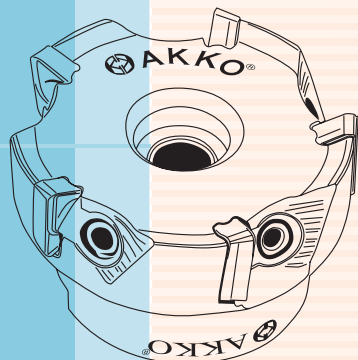

MILLING TOOLS

- P114 Milling Tools Designation System
- P115-P122 S-System End Mills
- P123-P124 S-System Modular End Mills
- P125 Ball Nose End Mills
- P126 S-System Helix End Mills
- P127 S-System Chamfering End Mills
- P129-P139 Face and Copy Milling
- P140 High Feed Milling Tools
- P141 Disc Milling
- P142 T Slot Milling
- P143 U-Drill Technical Informations
- P144 Milling Tools Technical Informations
- P145 Mounting Reference For Milling Cutters
- P146-P153 Spare Parts

EXTERNAL TURNING TOOLHOLDERS

KESİCİ UÇ BAĞLAMA SİSTEMLERİ

CONNECTION SYSTEMS FOR CUTTING INSERTS



DIŞ TORNA TAKIMLARI
EXTERNAL TURNING TOOLHOLDERS



1

P S K N R

1 2 3 4 5

1 Sıkma Tipi / Method of Mounting of Insert

Deliksiz Üstten Sıkma Top clamping without hole	Üstten Delikle Sıkma Top and Hole Clamping	Üstten ve Delikten Sıkma Top and Hole Clamping	Delikten Levele ile Sıkma Hole Clamping (Lever Lock)	Vida ile Sıkma Screw on
C	T	M	P	S

2 Uç Tipi / Insert Shape

C	D	E	K
L	R	S	T
V	W	A	B
H	M	O	P

3 Yanaşma Açısı / ToolHolder Shape

B	D	E	F	G	J
K	L	M	N	R	S
T	V	Y	Z		

4 Serbest Uç Açısı / Clearance angle of Insert

A	B	C
D	E	F
G	N	P

25 25 - M 12 C

6 7 8 9 10

5 Kesme Yönü / Cutting Direction

L	N	R

6 Kesme Kenar Yüksekliği / Cutting Edge Height

7 Şaft Genişliği / Shank Width

8 Şaft Boyu / Shank Length

A - 32	H - 100	Q - 180	x-special
B - 40	J - 110	R - 200	
C - 50	K - 125	S - 250	
D - 60	L - 140	T - 300	
E - 70	M - 150	U - 350	
F - 80	N - 160	V - 400	
G - 90	P - 170	W - 450	

(mm)

9 Kesme Kenar Uzunluğu / Cutting Edge Length

10 Baskı Pabucu / Wedge Clamp



T SISTEM

T-SİSTEM DIŞ TORNA KATERLERİ
T SYSTEM EXTERNAL TURNING TOOLHOLDERS



T-SİSTEM DIŞ TORNA KATERLERİ

T-SYSTEM EXTERNAL TURNING TOOLHOLDERS

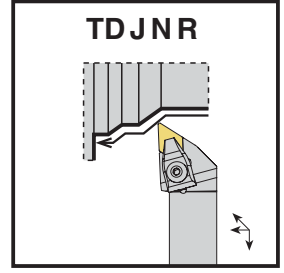
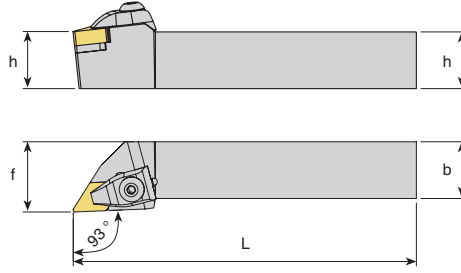

Takım Kodu Ordering Code	Stok Stock		Kater Ölçüleri (mm) Dimension (mm)				Kesici Uç Insert	Yedek Parçaları Spare Parts						
	R	L	h	b	L	f		Baskı Parçası Wedge Clamp	Baskı Vidası Screw	Altlık Shim	Altlık Vidası Shim Screw	Yay Spring	Pul Stamp	Anahtar Allen Key
TDJNR/L 1616 H 11	●	●	16	16	100	20	DNM. 11 04..							
2020 K 11	●	●	20	20	125	25								
2525 M11	●	●	25	25	150	32								
2020 K 15	●	●	20	20	125	25	DNM. 15 06..							
2525 M15	●	●	25	25	150	32								
3232 P 15	●	●	32	32	170	40								
4040 S 15	●	●	40	40	250	50								
5050 S 15	○	○	50	50	250	63								

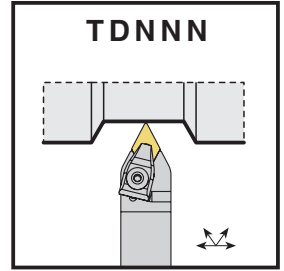
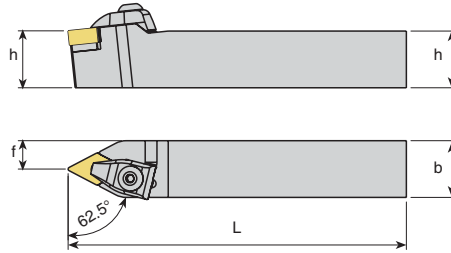

Takım Kodu Ordering Code	Stok Stock		Kater Ölçüleri (mm) Dimension (mm)				Kesici Uç Insert	Yedek Parçaları Spare Parts						
	R	L	h	b	L	f		Baskı Parçası Wedge Clamp	Baskı Vidası Screw	Altlık Shim	Altlık Vidası Shim Screw	Yay Spring	Pul Stamp	Anahtar Allen Key
TDNNN 1616 H 11	●	●	16	16	100	8	DNM. 11 04..							
2020 K 11	●	●	20	20	125	10								
2525 M11	●	●	25	25	150	12.5								
2020 K 15	●	●	20	20	125	10	DNM. 15 06..							
2525 M15	●	●	25	25	150	12.5								
3232 P 15	●	●	32	32	170	16								
4040 S 15	○	○	40	40	250	20								
5050 S 15	○	○	50	50	250	25								

R: Sağ/Right L: Sol/Left ● Stokta/In Stock ○ Stokta Yok/Non Stock Item

Sipariş Örneği/Ordering Example : 1 ad./pcs. TDNNN 1616 H11

T-SİSTEM DIŞ TORNA KATERLERİ

T-SYSTEM EXTERNAL TURNING TOOLHOLDERS

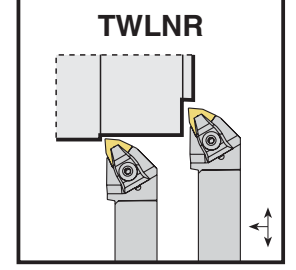
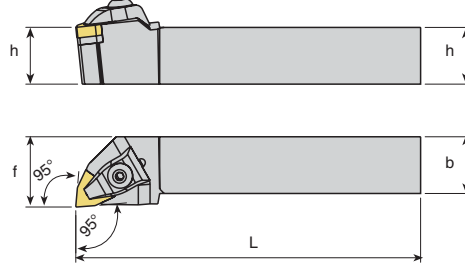

Takım Kodu Ordering Code	Stok Stock		Kater Ölçüleri (mm) Dimension (mm)				Kesici Uç Insert	Yedek Parçaları Spare Parts						
	R	L	h	b	L	f		Baskı Parçası Wedge Clamp	Baskı Vidası Screw	Altık Shim	Altık Vidası Shim Screw	Yay Spring	Pul Stamp	Anahtar Allen Key
TWLNR/L 1616 H 06	●	●	16	16	100	20	WNM. 06 04..	ATK-01	AKV-01-M5x20	AAWN-SW317	AAV-01-M3x10	-	ABPL-01	AAL-03-3
2020 K 06	●	●	20	20	125	25								
2525 M06	●	●	25	25	150	32								
2020 K 08	●	●	20	20	125	25	WNM. 08 04..	ATK-02	AKV-02-M6x20	AAWN-3-0001	AAV-02-M5x12	AKY-01	ABPL-01	AAL-03-3
2525 M08	●	●	25	25	150	32								
3232 P 08	●	●	32	32	170	40								
4040 S 08	○	○	40	40	250	50								
5050 S 08	○	○	50	50	250	63								

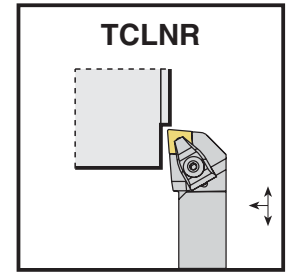
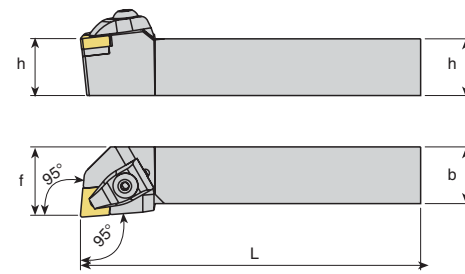
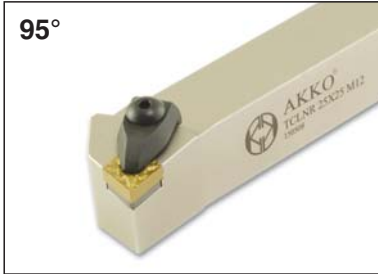

Takım Kodu Ordering Code	Stok Stock		Kater Ölçüleri (mm) Dimension (mm)				Kesici Uç Insert	Yedek Parçaları Spare Parts						
	R	L	h	b	L	f		Baskı Parçası Wedge Clamp	Baskı Vidası Screw	Altık Shim	Altık Vidası Shim Screw	Yay Spring	Pul Stamp	Anahtar Allen Key
TCLNR/L 2020 K 12	●	●	20	20	125	25	CNM. 12 04..	ATK-02	AKV-02-M6x20	AACN-3-0001	AAV-02-M5x12	AKY-01	ABPL-01	AAL-03-3
2525 M12	●	●	25	25	150	32								
3232 P 12	●	●	32	32	170	40								
4040 S 12	○	○	40	40	250	50								
5050 S 12	○	○	50	50	250	63								
2525 M16	●	●	25	25	150	32	CNM. 16 06..	ATK-04	AKV-05-M6x25	AACN-3-0002	AAV-05-M6x15	-	-	AAL-05-4
3232 P 16	●	●	32	32	170	40								

R: Sağ/Right L: Sol/Left ● Stokta/In Stock ○ Stokta Yok/Non Stock Item

Sipariş Örneği/Ordering Example : 1 ad./pcs. TCLNR 2020 K12

T-SİSTEM DIŞ TORNA KATERLERİ

T-SYSTEM EXTERNAL TURNING TOOLHOLDERS

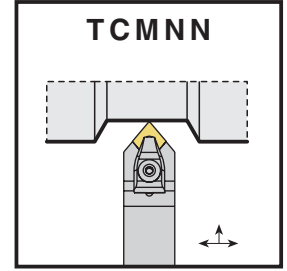
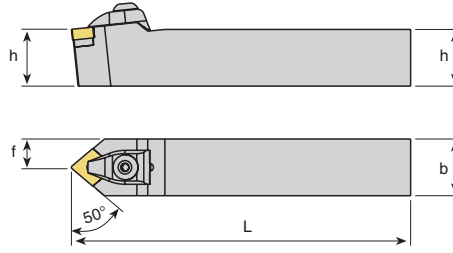

Takım Kodu Ordering Code	Stok Stock	Kater Ölçüleri (mm) Dimension (mm)				Kesici Uç Insert	Yedek Parçaları Spare Parts						
		h	b	L	f		Baskı Parçası Wedge Clamp	Baskı Vidası Screw	Altılık Shim	Altılık Vidası Shim Screw	Yay Spring	Pul Stamp	Anahtar Allen Key
TCMNN 1616 H 12	●	16	16	100	8	CNM. 12 04..							
2020 K 12	●	20	20	125	10								
2525 M12	●	25	25	150	12.5								
3232 P 12	●	32	32	170	16	CNM. 16 06..					-	-	
3232 P 16	○	32	32	170	16								
4040 S 16	○	40	40	250	20								

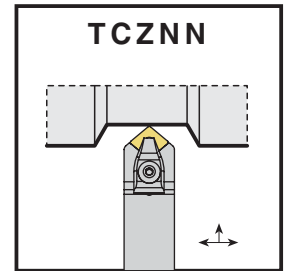
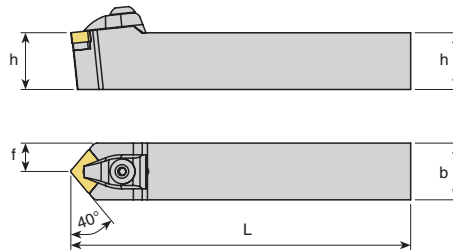

Takım Kodu Ordering Code	Stok Stock	Kater Ölçüleri (mm) Dimension (mm)				Kesici Uç Insert	Yedek Parçaları Spare Parts						
		h	b	L	f		Baskı Parçası Wedge Clamp	Baskı Vidası Screw	Altılık Shim	Altılık Vidası Shim Screw	Yay Spring	Pul Stamp	Anahtar Allen Key
TCZNN 2020 K 12	●	20	20	125	10	CNM. 12 04..							
2525 M12	●	25	25	150	12.5								
3232 P 12	●	32	32	170	16								

R: Sağ/Right L: Sol/Left ● Stokta/In Stock ○ Stokta Yok/Non Stock Item

Sipariş Örneği/Ordering Example : 1 ad./pcs. TCZNN 2020 K12

T-SİSTEM DIŞ TORNA KATERLERİ

T-SYSTEM EXTERNAL TURNING TOOLHOLDERS

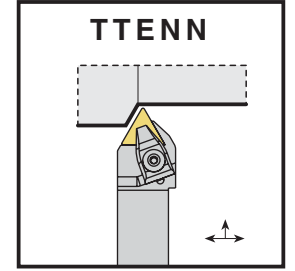
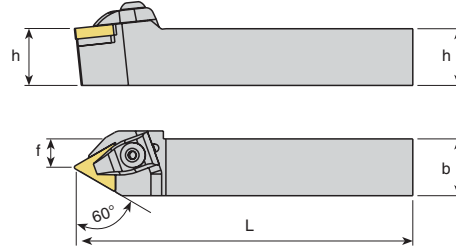

Takım Kodu Ordering Code	Stok Stock		Kater Ölçüleri (mm) Dimension (mm)				Kesici Uç Insert	Yedek Parçaları Spare Parts						
	R	L	h	b	L	f		Baskı Parçası Wedge Clamp	Baskı Vidası Screw	Altılık Shim	Altılık Vidası Shim Screw	Yay Spring	Pul Stamp	Anahtar Allen Key
TTENN 2020 K 16	●		20	20	125	10	TNM. 16 04..							
2525 M16	●		25	25	150	12.5								
3232 P 16	●		32	32	170	16								
2525 M22	●		25	25	150	12.5	TNM. 22 04..							
3232 P 22	●		32	32	170	16								
4040 S 22	○		40	40	250	20								

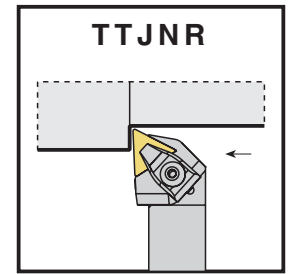
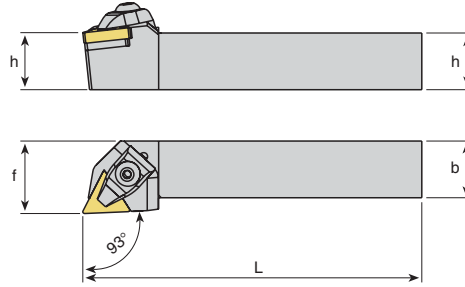

Takım Kodu Ordering Code	Stok Stock		Kater Ölçüleri (mm) Dimension (mm)				Kesici Uç Insert	Yedek Parçaları Spare Parts						
	R	L	h	b	L	f		Baskı Parçası Wedge Clamp	Baskı Vidası Screw	Altılık Shim	Altılık Vidası Shim Screw	Yay Spring	Pul Stamp	Anahtar Allen Key
TTJNR/L 2020 K 16	●	●	20	20	125	25	TNM. 16 04..							
2525 M16	●	●	25	25	150	32								
3232 P 16	●	●	32	32	170	40								
2525 M22	●	●	25	25	150	32	TNM. 22 04..							
3232 P 22	●	●	32	32	170	40								
4040 S 22	○	○	40	40	250	50								

R: Sağ/Right L: Sol/Left ● Stokta/In Stock ○ Stokta Yok/Non Stock Item

Sipariş Örneği/Ordering Example : 1 ad./pcs. TTJNR 2020 K16

T-SİSTEM DIŞ TORNA KATERLERİ

T-SYSTEM EXTERNAL TURNING TOOLHOLDERS

91°

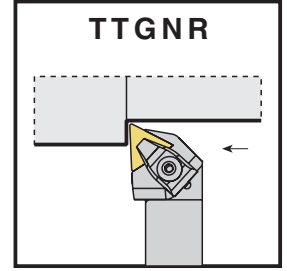
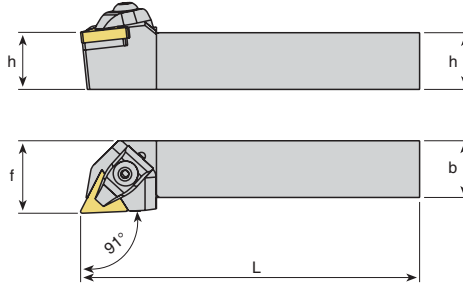

Takım Kodu Ordering Code	Stok Stock		Kater Ölçüleri (mm) Dimension (mm)				Kesici Uç Insert	Yedek Parçaları Spare Parts													
	R	L	h	b	L	f		Baskı Parçası Wedge Clamp	Baskı Vidası Screw	Altlık Shim	Altlık Vidası Shim Screw	Yay Spring	Pul Stamp	Anahtar Allen Key							
TTGNR/L 2020 K 16	●	●	20	20	125	25															
2525 M16	●	●	25	25	150	32									TNM. 16 04..	ATK-01	AKV-01-M5x20	AATN-2-0002	AAV-03-M5x12	-	
3232 P 16	○	○	32	32	170	40														ABPL-01	AAL-03-3
2525 M22	●	●	25	25	150	32	TNM. 22 04..	ATK-02	AKV-02-M6x20	AATN-3-0015	AAV-02-M5x12	AKY-01									
3232 P 22	○	○	32	32	170	40															
4040 S 22	○	○	40	40	250	50															

93°

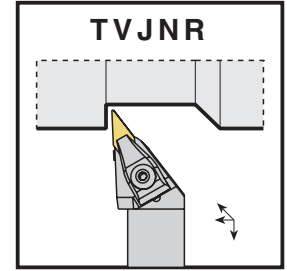
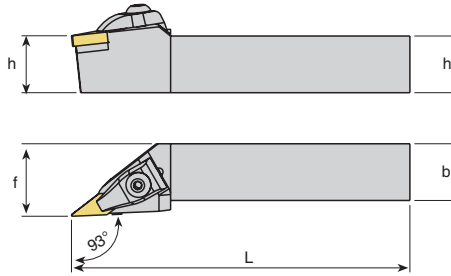

Takım Kodu Ordering Code	Stok Stock		Kater Ölçüleri (mm) Dimension (mm)				Kesici Uç Insert	Yedek Parçaları Spare Parts														
	R	L	h	b	L	f		Baskı Parçası Wedge Clamp	Baskı Vidası Screw	Altlık Shim	Altlık Vidası Shim Screw	Yay Spring	Pul Stamp	Anahtar Allen Key								
TVJNR/L 2020 K 16	●	●	20	20	125	25																
2525 M16	●	●	25	25	150	32									VNM. 16 04..	ATK-03	AKV-02-M6x20	AAVN-2-0002	AAV-04-M5x12	AKY-01	ABPL-01	AAL-03-3
3232 P 16	●	●	32	32	170	40																

R: Sağ/Right L: Sol/Left ● Stokta/In Stock ○ Stokta Yok/Non Stock Item

Sipariş Örneği/Ordering Example : 1 ad./pcs. TVJNR 2020 K16

T-SİSTEM DIŞ TORNA KATERLERİ

T-SYSTEM EXTERNAL TURNING TOOLHOLDERS

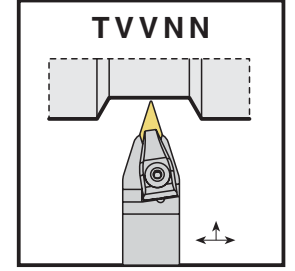
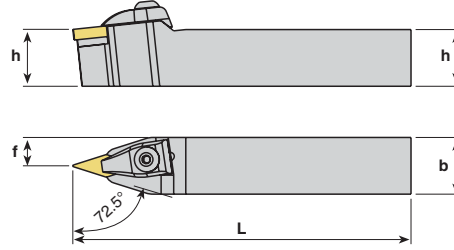

Takım Kodu Ordering Code	Stok Stock	Kater Ölçüleri (mm) Dimension (mm)				Kesici Uç Insert	Yedek Parçaları Spare Parts								
		R	L	h	b		L	f	Baskı Parçası Wedge Clamp	Baskı Vidası Screw	Altlık Shim	Altlık Vidası Shim Screw	Yay Spring	Pul Stamp	Anahtar Allen Key
TVVNN 2020 K 16	●			20	20	125	10	VNM. 16 04..	ATK-03	AKV-02-M6x20	AAVN-2-0002	AAV-04-M5x12	AKY-01	ABPL-01	AAL-03-3
2525 M16	●			25	25	150	12,5								
3232 P 16	●			32	32	170	16								

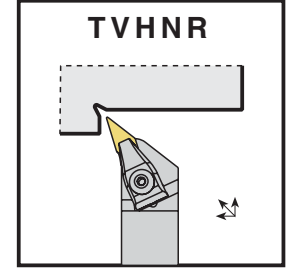
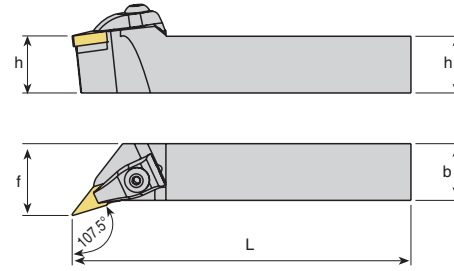

Takım Kodu Ordering Code	Stok Stock		Kater Ölçüleri (mm) Dimension (mm)				Kesici Uç Insert	Yedek Parçaları Spare Parts						
	R	L	h	b	L	f		Baskı Parçası Wedge Clamp	Baskı Vidası Screw	Altlık Shim	Altlık Vidası Shim Screw	Yay Spring	Pul Stamp	Anahtar Allen Key
TVHNR/L 2020 K 16	●	●	20	20	125	25	VNM. 16 04..	ATK-03	AKV-02-M6x20	AAVN-2-0002	AAV-04-M5x12	AKY-01	ABPL-01	AAL-03-3
2525 M16	●	●	25	25	150	32								
3232 P 16	○	○	32	32	170	40								

R: Sağ/Right L: Sol/Left ● Stokta/In Stock ○ Stokta Yok/Non Stock Item

Sipariş Örneği/Ordering Example : 1 ad./pcs. TVHNR 2020 K16

T-SİSTEM DIŞ TORNA KATERLERİ

T-SYSTEM EXTERNAL TURNING TOOLHOLDERS

45°

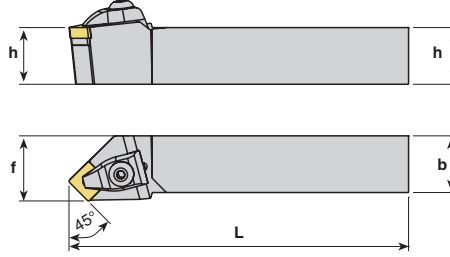

TSSNR

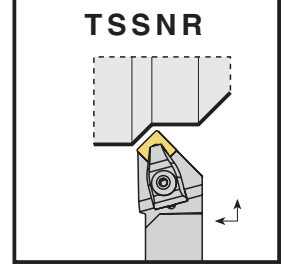

Takım Kodu Ordering Code	Stok Stock		Kater Ölçüleri (mm) Dimension (mm)				Kesici Uç Insert	Yedek Parçaları Spare Parts													
	R	L	h	b	L	f		Baskı Parçası Wedge Clamp	Baskı Vidası Screw	Altlık Shim	Altlık Vidası Shim Screw	Yay Spring	Pul Stamp	Anahtar Allen Key							
TSSNR/L2020 K 12	●	●	20	20	125	25	SNM. 12 04..														
2525 M12	●	●	25	25	150	32									ATK-02	AKV-02-M6x20	AASN-3-0004	AAV-02-M5x12	AKY-01	ABPL-01	AAL-03-3
3232 P 12	●	●	32	32	170	40															
2525 M15	●	●	25	25	150	32	SNM. 15 06..	ATK-04	AKV-05-M6x25	AASN-3-0023	AAV-05-M6x15	-	-	AAL-05-4							

45°

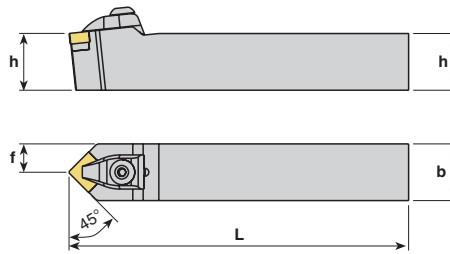

TSDNN

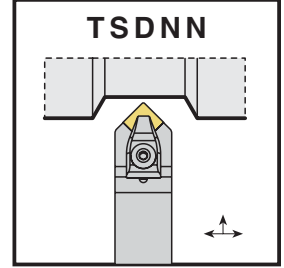

Takım Kodu Ordering Code	Stok Stock		Kater Ölçüleri (mm) Dimension (mm)				Kesici Uç Insert	Yedek Parçaları Spare Parts													
			h	b	L	f		Baskı Parçası Wedge Clamp	Baskı Vidası Screw	Altlık Shim	Altlık Vidası Shim Screw	Yay Spring	Pul Stamp	Anahtar Allen Key							
TSDNN 1616 H 12	●		16	16	100	8	SNM. 12 04..														
2020 K 12	●		20	20	125	10									ATK-02	AKV-02-M6x20	AASN-3-0004	AAV-02-M5x12	AKY-01	ABPL-01	AAL-03-3
2525 M12	●		25	25	150	12.5															
3232 P 12	●		32	32	170	16															
2525 M15	○		25	25	150	12.5	SNM. 15 06..	ATK-04	AKV-05-M6x25	AASN-3-0023	AAV-05-M6x15	-	-	AAL-05-4							
3232 P 15	○		32	32	170	16															
4040 S 15	○		40	40	250	20															

R: Sağ/Right L: Sol/Left ● Stokta/In Stock ○ Stokta Yok/Non Stock Item

Sipariş Örneği/Ordering Example : 1 ad./pcs. TSDNN 1616 H12

T-SİSTEM DIŞ TORNA KATERLERİ

T-SYSTEM EXTERNAL TURNING TOOLHOLDERS

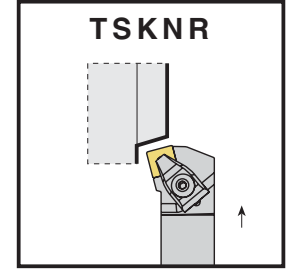
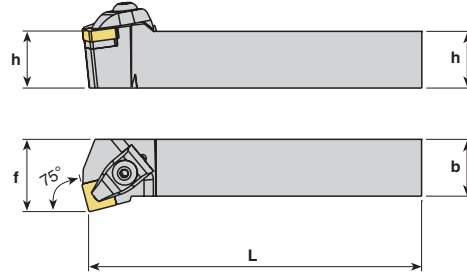

Takım Kodu Ordering Code	Stok Stock		Kater Ölçüleri (mm) Dimension (mm)				Kesici Uç Insert	Yedek Parçaları Spare Parts						
	R	L	h	b	L	f		Baskı Parçası Wedge Clamp	Baskı Vidası Screw	Altlık Shim	Altlık Vidası Shim Screw	Yay Spring	Pul Stamp	Anahtar Allen Key
TSKNR/L 2020 K 12	●	●	20	20	125	25	SNM. 12 04..							
2525 M12	●	●	25	25	150	32								
3232 P 12	●	●	32	32	170	40								

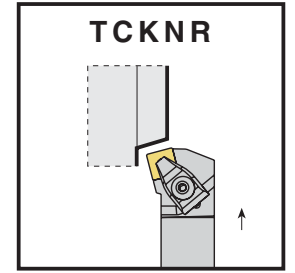
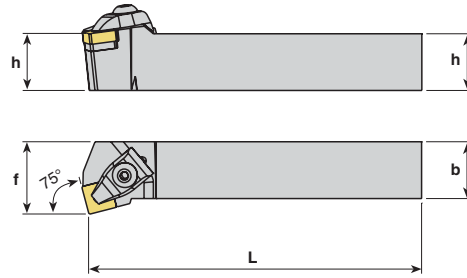

Takım Kodu Ordering Code	Stok Stock		Kater Ölçüleri (mm) Dimension (mm)				Kesici Uç Insert	Yedek Parçaları Spare Parts						
	R	L	h	b	L	f		Baskı Parçası Wedge Clamp	Baskı Vidası Screw	Altlık Shim	Altlık Vidası Shim Screw	Yay Spring	Pul Stamp	Anahtar Allen Key
TCKNR/L 2020 K 12	○	○	20	20	125	25	CNM. 12 04..							
2525 M12	○	○	25	25	150	32								
3232 P 12	●	●	32	32	170	40								
2525 M16	○	○	25	25	150	32	CNM. 16 06..							
3232 P 16	●	○	32	32	170	40								

R: Sağ/Right L: Sol/Left ● Stokta/In Stock ○ Stokta Yok/Non Stock Item

Sipariş Örneği/Ordering Example : 1 ad./pcs. TCKNR 3232 P12



M SISTEM

M SISTEM DIŞ TORNA KATERLERİ
M SYSTEM EXTERNAL TURNING TOOLHOLDERS



M-SİSTEM DIŞ TORNA KATERLERİ

M-SYSTEM EXTERNAL TURNING TOOLHOLDERS

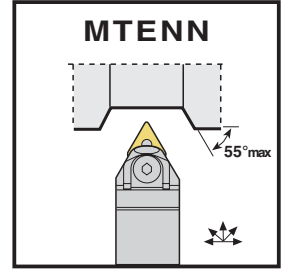
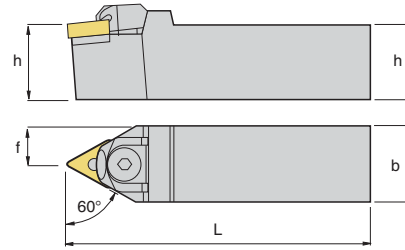

Takım Kodu Ordering Code	Stok Stock	Kater Ölçüleri (mm) Dimension (mm)				Kesici Uç Insert	Yedek Parçaları Spare Parts					
		h	b	L	f		Baskı Parçası Wedge Clamp	Baskı Vidası Screw	Altılık Shim	Pim Pin	Pul Stamp	Anahtar Allen Key
MTENN 2020 K 16	●	20	20	125	10	TNM. 16 04..	AMK-04	AKV-02-M6x20	AATN-2-0002	APM-01	ABPL-01	AAL-03-3
2525 M16	●	25	25	150	12.5							
3232 P 16	●	32	32	170	16	TNM. 22 04..	AMK-04	AKV-02-M6x20	AATN-3-0015	APM-02	ABPL-01	AAL-03-3
2525 M22	●	25	25	150	12.5							
3232 P 22	●	32	32	170	16							
4040 S 22	○	40	40	250	20							

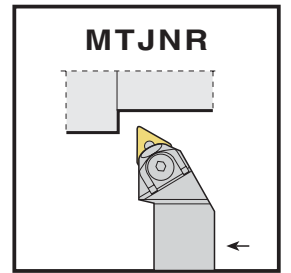
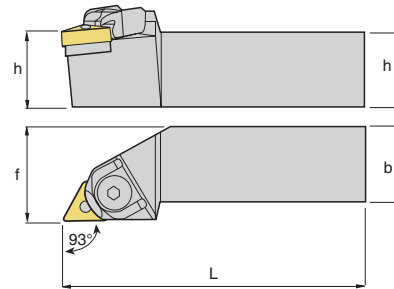

Takım Kodu Ordering Code	Stok Stock		Kater Ölçüleri (mm) Dimension (mm)				Kesici Uç Insert	Yedek Parçaları Spare Parts					
	R	L	h	b	L	f		Baskı Parçası Wedge Clamp	Baskı Vidası Screw	Altılık Shim	Pim Pin	Pul Stamp	Anahtar Allen Key
MTJNR/L 2020 K 16	●	●	20	20	125	25	TNM. 16 04..	AMK-04	AKV-02-M6x20	AATN-2-0002	APM-01	ABPL-01	AAL-03-3
2525 M16	●	●	25	25	150	32							
3232 P 16	●	●	32	32	170	40	TNM. 22 04..	AMK-04	AKV-02-M6x20	AATN-3-0015	APM-02	ABPL-01	AAL-03-3
2525 M22	●	●	25	25	150	32							
3232 P 22	●	●	32	32	170	40							
4040 S 22	●	○	40	40	250	50							

R: Sağ/Right L: Sol/Left ● Stokta/In Stock ○ Stokta Yok/Non Stock Item

Sipariş Örneği/Ordering Example : 1 ad./pcs. MTJNR 2020 K16

M-SİSTEM DIŞ TORNA KATERLERİ

M-SYSTEM EXTERNAL TURNING TOOLHOLDERS

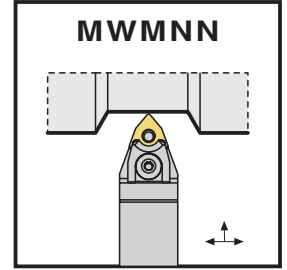
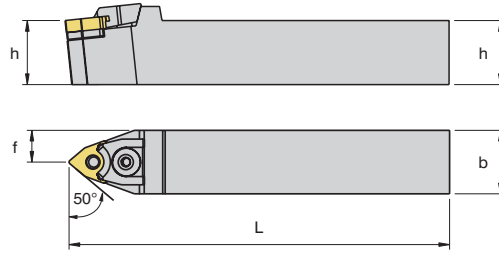

Takım Kodu Ordering Code	Stok Stock		Kater Ölçüleri (mm) Dimension (mm)				Kesici Uç Insert	Yedek Parçaları Spare Parts					
	R	L	h	b	L	f		Baskı Parçası Wedge Clamp	Baskı Vidası Screw	Altlık Shim	Pim Pin	Pul Stamp	Anahtar Allen Key
MWMNN 1616 H 06-Z	○		16	16	100	8							
2020 K 06-Z	○		20	20	125	10							
2525 M06-Z	○		25	25	150	12.5							
2020 K 08	●		20	20	125	10							
2525 M08	●		25	25	150	12.5							
3232 P 08	●		32	32	170	16							

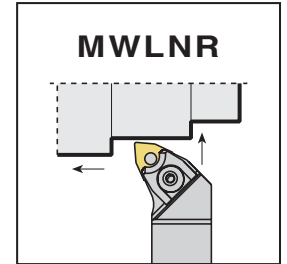
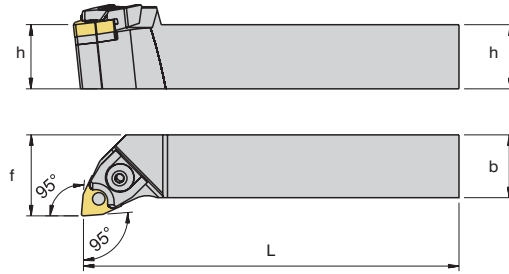

Takım Kodu Ordering Code	Stok Stock		Kater Ölçüleri (mm) Dimension (mm)				Kesici Uç Insert	Yedek Parçaları Spare Parts					
	R	L	h	b	L	f		Baskı Parçası Wedge Clamp	Baskı Vidası Screw	Altlık Shim	Pim Pin	Pul Stamp	Anahtar Allen Key
MWLNR/L 1616 H 06-Z	○	○	16	16	100	20							
2020 K 06-Z	●	●	20	20	125	25							
2525 M06-Z	●	●	25	25	150	32							
2020 K 08	●	●	20	20	125	25							
2525 M08	●	●	25	25	150	32							
3232 P 08	●	●	32	32	170	40							

R: Sağ/Right L: Sol/Left ● Stokta/In Stock ○ Stokta Yok/Non Stock Item

Sipariş Örneği/Ordering Example : 1 ad./pcs. MWLNR 2020 K08



S SISTEM

S SISTEM DIŞ TORNA KATERLERİ
S SYSTEM EXTERNAL TURNING TOOLHOLDERS



S-SİSTEM DIŞ TORNA KATERLERİ

S-SYSTEM EXTERNAL TURNING TOOLHOLDERS

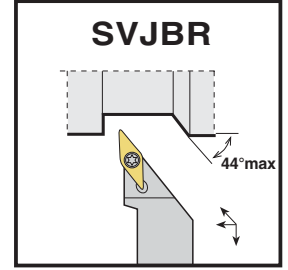
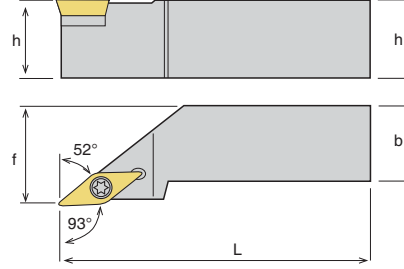

Takım Kodu Ordering Code	Stok Stock		Kater Ölçüleri (mm) Dimension (mm)				Kesici Uç Insert	Yedek Parçaları Spare Parts			
	R	L	h	b	L	f		Sıkma Vidası Clamp Screw	Altlık Shim	Altlık Vidası Shim Screw	Tork Anahtar Torx Key
SVJBR/L 1212 F 11	●	●	12	12	80	16					
1616 H 11	●	●	16	16	100	20					
2020 K 11	●	●	20	20	125	25					
2020 K 16	●	●	20	20	125	25	VBM. 16 04..	1015-M3.5x14	AAVN-2-0002	AAV-06-M3.5x11	80-T15
2525 M16	●	●	25	25	150	32					
3232 P 16	●	●	32	32	170	40					

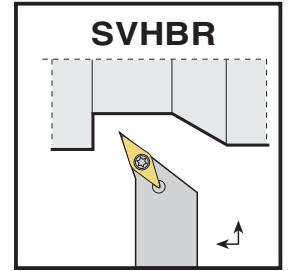
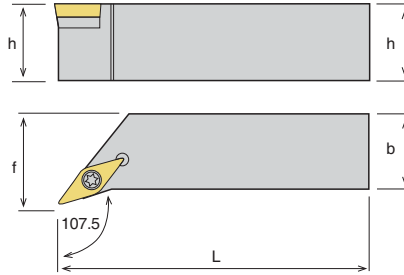

Takım Kodu Ordering Code	Stok Stock		Kater Ölçüleri (mm) Dimension (mm)				Kesici Uç Insert	Yedek Parçaları Spare Parts			
	R	L	h	b	L	f		Sıkma Vidası Clamp Screw	Altlık Shim	Altlık Vidası Shim Screw	Tork Anahtar Torx Key
SVHBR/L 1212 F 11	●	●	12	12	80	16					
1616 H 11	●	●	16	16	100	20					
2020 K 11	●	●	20	20	125	25					
2020 K 16	●	●	20	20	125	25	VBM. 16 04..	1015-M3.5x14	AAVN-2-0002	AAV-06-M3.5x11	80-T15
2525 M16	●	●	25	25	150	32					
3232 P 16	●	●	32	32	170	40					

R: Sağ/Right L: Sol/Left ● Stokta/In Stock ○ Stokta Yok/Non Stock Item

Sipariş Örneği/Ordering Example : 1 ad./pcs. SVHBR 1212 F11

S-SİSTEM DIŞ TORNA KATERLERİ

S-SYSTEM EXTERNAL TURNING TOOLHOLDERS

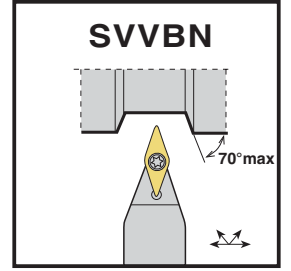
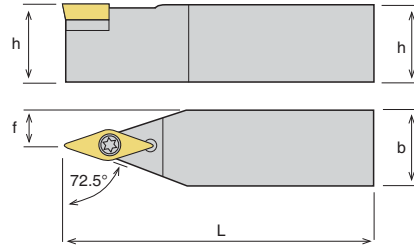

Takım Kodu Ordering Code	Stok Stock	Kater Ölçüleri (mm) Dimension (mm)				Kesici Uç Insert	Yedek Parçaları Spare Parts			
		h	b	L	f		Sıkma Vidası Clamp Screw	Altık Shim	Altık Vidası Shim Screw	Tork Anahtar Torx Key
SVVBN 1212 F 11	●	12	12	80	06	VBM. 11 03..	1008-M2.5x7	-	-	80-T08
1616 H 11	●	16	16	100	08					
2020 K 11	●	20	20	125	10					
2020 K 16	●	20	20	125	10	VBM. 16 04..	1015-M3.5x14	AAVN-2-0002	AAV-06-M3.5x11	80-T15
2525 M16	●	25	25	150	12.5					
3232 P 16	●	32	32	170	16					

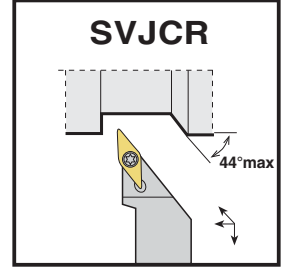
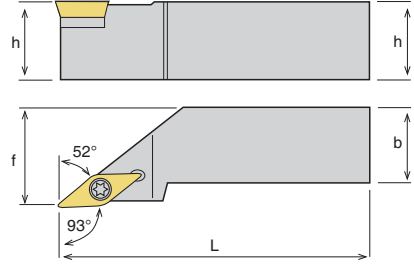

Takım Kodu Ordering Code	Stok Stock		Kater Ölçüleri (mm) Dimension (mm)				Kesici Uç Insert	Yedek Parçaları Spare Parts			
	R	L	h	b	L	f		Sıkma Vidası Clamp Screw	Altık Shim	Altık Vidası Shim Screw	Tork Anahtar Torx Key
SVJCR/L1212 F 11	●	●	12	12	80	16	VCM. 11 03..	1008-M2.5x7	-	-	80-T08
1616 H 11	●	●	16	16	100	20					
2020 K 11	●	●	20	20	125	25					
2020 K 16	●	●	20	20	125	25	VCM. 16 04..	1015-M3.5x14	AAVN-2-0002	AAV-06-M3.5x11	80-T15
2525 M16	●	●	25	25	150	32					
3232 P 16	●	●	32	32	170	40					

R: Sağ/Right L: Sol/Left ● Stokta/In Stock ○ Stokta Yok/Non Stock Item

Sipariş Örneği/Ordering Example : 1 ad./pcs. SVJCR 1212 F11

S-SİSTEM DIŞ TORNA KATERLERİ

S-SYSTEM EXTERNAL TURNING TOOLHOLDERS

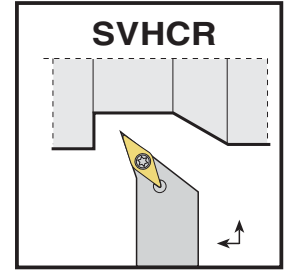
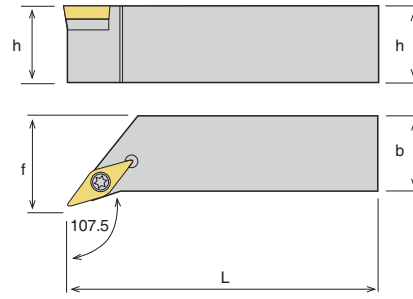

Takım Kodu Ordering Code	Stok Stock		Kater Ölçüleri (mm) Dimension (mm)				Kesici Uç Insert	Yedek Parçaları Spare Parts			
	R	L	h	b	L	f		Sıkma Vidası Clamp Screw	Altlık Shim	Altlık Vidası Shim Screw	Tork Anahtar Torx Key
SVHCR/L1212 F 11	●	●	12	12	80	16					
1616 H 11	●	●	16	16	100	20					
2020 K 11	●	●	20	20	125	25					
2020 K 16	●	●	20	20	125	25					
2525 M16	●	●	25	25	150	32	VCM. 16 04..	1015-M3.5x14	AAVN-2-0002	AAV-06-M3.5x11	80-T15
3232 P 16	●	●	32	32	170	40					

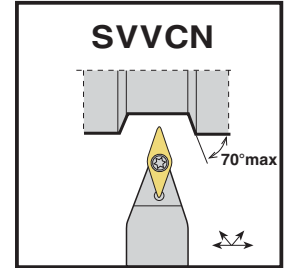
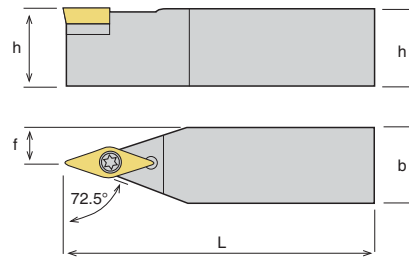

Takım Kodu Ordering Code	Stok Stock		Kater Ölçüleri (mm) Dimension (mm)				Kesici Uç Insert	Yedek Parçaları Spare Parts			
	R	L	h	b	L	f		Sıkma Vidası Clamp Screw	Altlık Shim	Altlık Vidası Shim Screw	Tork Anahtar Torx Key
SVVCN 1212 F 11	●	●	12	12	80	06					
1616 H 11	●	●	16	16	100	08					
2020 K 11	●	●	20	20	125	10					
2020 K 16	●	●	20	20	125	10					
2525 M16	●	●	25	25	150	12.5	VCM. 16 04..	1015-M3.5x14	AAVN-2-0002	AAV-06-M3.5x11	80-T15
3232 P 16	●	●	32	32	170	16					

R: Sağ/Right L: Sol/Left ● Stokta/In Stock ○ Stokta Yok/Non Stock Item

Sipariş Örneği/Ordering Example : 1 ad./pcs. SVVCN 1212 F11

S-SİSTEM DIŞ TORNA KATERLERİ

S-SYSTEM EXTERNAL TURNING TOOLHOLDERS

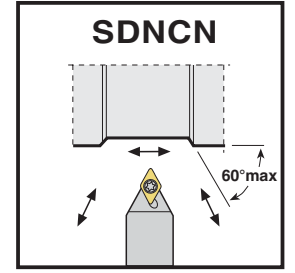
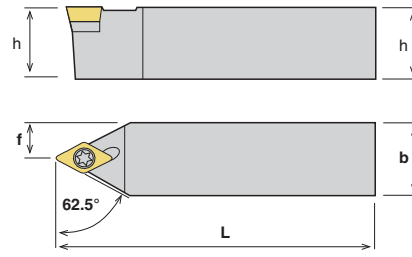

Takım Kodu Ordering Code	Stok Stock	Kater Ölçüleri (mm) Dimension (mm)				Kesici Uç Insert	Yedek Parçaları Spare Parts			
		h	b	L	f		Sıkma Vidası Clamp Screw	Altık Shim	Altık Vidası Shim Screw	Tork Anahtar Torx Key
SDNCN 0808 E 07	●	08	08	70	04					
1010 E 07	●	10	10	70	05					
1212 F 07	●	12	12	80	06					
1616 H 07	●	16	16	100	08					
1616 H 11	●	16	16	100	08					
2020 K 11	●	20	20	125	10					
2525 M 11	●	25	25	150	12.5					
3232 P 11	●	32	32	170	16					

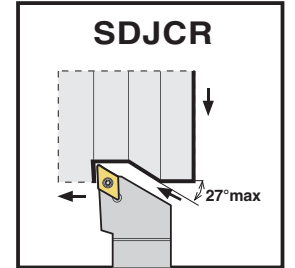
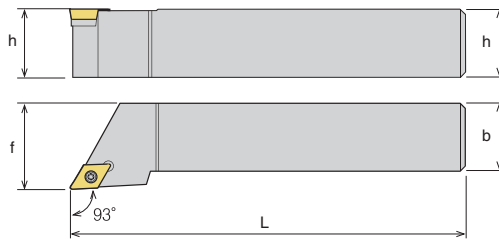

Takım Kodu Ordering Code	Stok Stock	Kater Ölçüleri (mm) Dimension (mm)				Kesici Uç Insert	Yedek Parçaları Spare Parts				
		R	L	h	b		L	f	Sıkma Vidası Clamp Screw	Altık Shim	Altık Vidası Shim Screw
SDJCR/L 0808 E 07	●	●	08	08	70	10					
1010 E 07	●	●	10	10	70	12					
1212 F 07	●	●	12	12	80	16					
1616 H 07	●	●	16	16	100	20					
1616 H 11	●	●	16	16	100	20					
2020 K 11	●	●	20	20	125	25					
2525 M 11	●	●	25	25	150	32					
3232 P 11	●	●	32	32	170	40					

R: Sağ/Right L: Sol/Left ● Stokta/In Stock ○ Stokta Yok/Non Stock Item

Sipariş Örneği/Ordering Example : 1 ad./pcs. SDJCR 0808 E07

S-SİSTEM DIŞ TORNA KATERLERİ

S-SYSTEM EXTERNAL TURNING TOOLHOLDERS

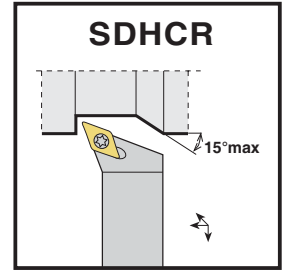
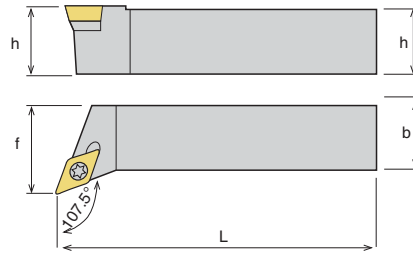

Takım Kodu Ordering Code	Stok Stock		Kater Ölçüleri (mm) Dimension (mm)				Kesici Uç Insert	Yedek Parçaları Spare Parts			
	R	L	h	b	L	f		Sıkma Vidası Clamp Screw	Altlık Shim	Altlık Vidası Shim Screw	Tork Anahtar Torx Key
SDHCR/L 0808 E 07	●	●	08	08	70	10	DCM. 07 02..	1008-M2.5x7	-	-	80-T08
1010 E 07	●	●	10	10	70	12					
1212 F 07	●	●	12	12	80	16					
1616 H 07	●	●	16	16	100	20					
1616 H 11	●	●	16	16	100	20	DCM. 11 T3..	1015-M3.5x14	AADN-2-0001	AAV-06-M3.5x11	80-T15
2020 K 11	●	●	20	20	125	25					
2525 M 11	●	●	25	25	150	32					
3232 P 11	●	●	32	32	170	40					

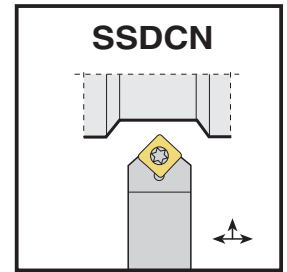
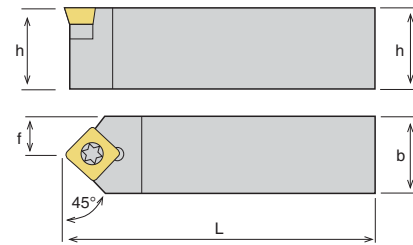

Takım Kodu Ordering Code	Stok Stock		Kater Ölçüleri (mm) Dimension (mm)				Kesici Uç Insert	Yedek Parçaları Spare Parts			
	R	L	h	b	L	f		Sıkma Vidası Clamp Screw	Altlık Shim	Altlık Vidası Shim Screw	Tork Anahtar Torx Key
SSDCN 1212 F 09	●	●	12	12	80	6	SCM. 09 T3..	1015-M3.5x9	-	-	80-T15
1616 H 09	●	●	16	16	100	8					
2020 K 09	●	●	20	20	125	10					
1616 H 12	●	●	16	16	100	8					
2020 K 12	●	●	20	20	125	10	SCM. 12 04..	1020-M4.5x16	AASN-2-0004	AAV-07-M4.5x11	80-T20
2525 M 12	●	●	25	25	150	12.5					

R: Sağ/Right L: Sol/Left ● Stokta/In Stock ○ Stokta Yok/Non Stock Item

Sipariş Örneği/Ordering Example : 1 ad./pcs. SSDCN 1212 F09

S-SİSTEM DIŞ TORNA KATERLERİ

S-SYSTEM EXTERNAL TURNING TOOLHOLDERS

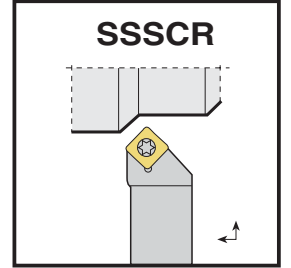
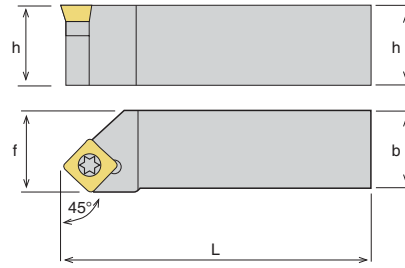

Takım Kodu Ordering Code	Stok Stock		Kater Ölçüleri (mm) Dimension (mm)				Kesici Uç Insert	Yedek Parçaları Spare Parts			
	R	L	h	b	L	f		Sıkma Vidası Clamp Screw	Altık Shim	Altık Vidası Shim Screw	Tork Anahtar Torx Key
	SSSCR/L 1212 F 09	●	●	12	12	80		16	SCM. 09 T3..	1015-M3.5x9	-
1616 H 09	●	●	16	16	100	20	1015-M3.5x14	AASN-2-0001		AAV-06-M3.5x11	
2020 K 09	●	●	20	20	125	25					
1616 H 12	○	○	16	16	100	20	SCM. 12 04..	1020-M4.5x16	AASN-2-0004	AAV-07-M4.5x11	80-T20
2020 K 12	●	●	20	20	125	25					
2525 M12	●	●	25	25	150	32					

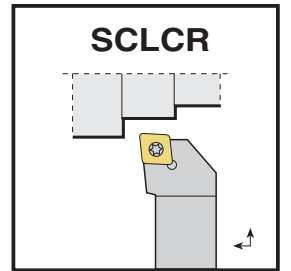
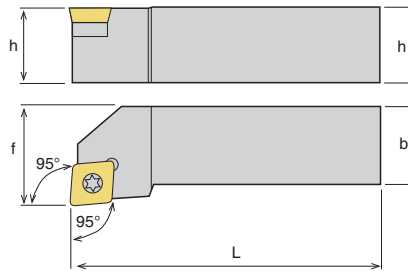
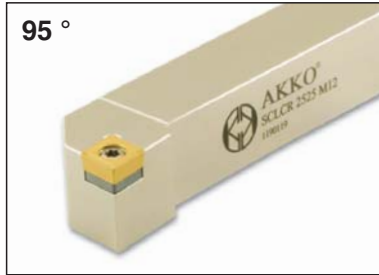

Takım Kodu Ordering Code	Stok Stock		Kater Ölçüleri (mm) Dimension (mm)				Kesici Uç Insert	Yedek Parçaları Spare Parts			
	R	L	h	b	L	f		Sıkma Vidası Clamp Screw	Altık Shim	Altık Vidası Shim Screw	Tork Anahtar Torx Key
	SCLCR/L 0808 E 06	●	●	08	08	70		10	CCM. 06 02..	1008-M2.5x7	-
1010 E 06	●	●	10	10	70	12	1015-M3.5x9	-		-	
1212 F 09	●	●	12	12	80	16	CCM. 09 T3..	1015-M3.5x14	AACN-2-0001	AAV-06-M3.5x11	80-T15
1616 H 09	●	●	16	16	100	20					
2020 K 09	●	●	20	20	125	25					
2020 K 12	●	●	20	20	125	25	CCM. 12 04..	1020-M4.5x16	AACN-2-0003	AAV-07-M4.5x11	80-T20
2525 M12	●	●	25	25	150	32					

R: Sağ/Right L: Sol/Left ● Stokta/In Stock ○ Stokta Yok/Non Stock Item

Sipariş Örneği/Ordering Example : 1 ad./pcs. SCLCR 0808 E06

S-SİSTEM DIŞ TORNA KATERLERİ

S-SYSTEM EXTERNAL TURNING TOOLHOLDERS

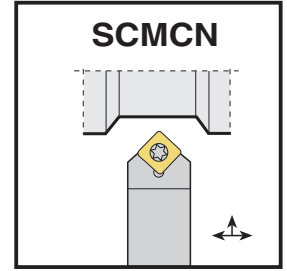
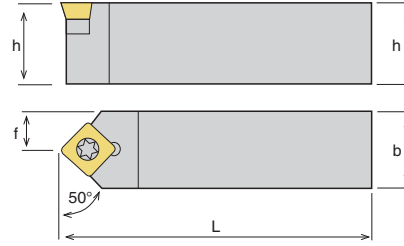

Takım Kodu Ordering Code	Stok Stock	Kater Ölçüleri (mm) Dimension (mm)				Kesici Uç Insert	Yedek Parçaları Spare Parts			
		h	b	L	f		Sıkma Vidası Clamp Screw	Altlık Shim	Altlık Vidası Shim Screw	Tork Anahtar Torx Key
SCMCN 0808 E 06	●	08	08	70	04	CCM. 06 02..	1008-M2.5x7	-	-	80-T08
1010 E 06	●	10	10	70	05					
1212 F 09	●	12	12	80	06	CCM. 09 T3..	1015-M3.5x9 1015-M3.5x14	-	-	80-T15
1616 H 09	●	16	16	100	08					
2020 K 12	○	20	20	125	10	CCM. 12 04..	1020-M4.5x16	AACN-2-0001	AAV-06-M3.5x11	80-T20
2525 M12	○	25	25	150	12,5					

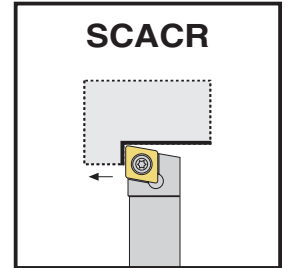
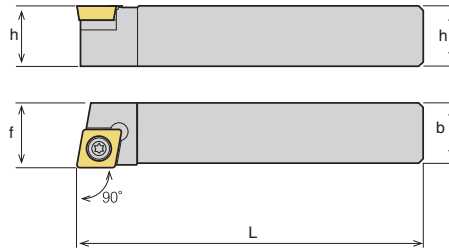

Takım Kodu Ordering Code	Stok Stock		Kater Ölçüleri (mm) Dimension (mm)				Kesici Uç Insert	Yedek Parçaları Spare Parts			
	R	L	h	b	L	f		Sıkma Vidası Clamp Screw	Altlık Shim	Altlık Vidası Shim Screw	Tork Anahtar Torx Key
SCACR/L 0808 E 06	○	○	08	08	70	10	CCM. 06 02..	1008-M2.5x7	-	-	80-T08
1010 E 06	○	○	10	10	70	12					
1212 F 09	●	●	12	12	80	16	CCM. 09 T3..	1015-M3.5x9 1015-M3.5x14	-	-	80-T15
1616 H 09	○	○	16	16	100	20					
2020 K 09	●	●	20	20	125	25	CCM. 12 04..	1020-M4.5x16	AACN-2-0001	AAV-06-M3.5x11	80-T20
2020 K 12	○	○	20	20	125	25					
2525 M12	○	○	25	25	150	32					

R: Sağ/Right L: Sol/Left ● Stokta/In Stock ○ Stokta Yok/Non Stock Item

Sipariş Örneği/Ordering Example : 1 ad./pcs. SCACR 0808 E06

S-SİSTEM DIŞ TORNA KATERLERİ

S-SYSTEM EXTERNAL TURNING TOOLHOLDERS

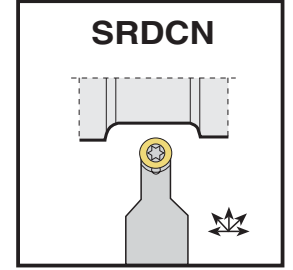
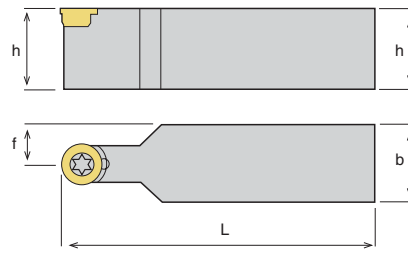

Takım Kodu Ordering Code	Stok Stock	Kater Ölçüleri (mm) Dimension (mm)				Kesici Uç Insert	Yedek Parçaları Spare Parts					
		h	b	L	f		Sıkma Vidası Clamp Screw	Altılık Shim	Altılık Vidası Shim Screw	Baskı Parçası Wedge Clamp	Baskı Vidası Screw	Tork Anahtar Torx Key
SRDCN 1616 H 06	○	16	16	100	8	RC.T 06 02..	1008-M2.5x7	-	-	-	-	80-T08
2020 K 06	●	20	20	125	10							
2525 M06	●	25	25	150	12.5							
1616 H 08C	●	16	16	100	8	RC.T 08 03..	1008-M3x9	-	-	-	-	80-T08
2020 K 08C	●	20	20	125	10							
2525 M08C	●	25	25	150	12.5							
1616 H 10C	●	16	16	100	8	RC.T 10 T3..	1015-M3.5x9	-	-	ACK-15	1015-M3.5x9	80-T15
2020 K 10C	●	20	20	125	10							
2525 M10C	●	25	25	150	12.5							
3232 P 10C	●	32	32	170	16	RC.T 12 04..	1015-M3.5x9	-	-	ACK-05	1515-M4x11	80-T20
2020 K 12C	●	20	20	125	10							
2525 M12C	●	25	25	150	12.5							
3232 P 12C	●	32	32	170	16	RC.T 16 05..	1020-M5x11	-	-	-	-	80-T20
3232 P 16C	●	32	32	170	16							

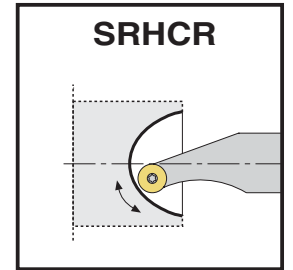
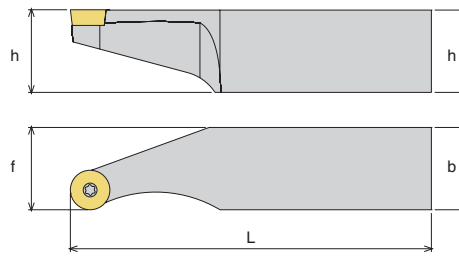

Takım Kodu Ordering Code	Stok Stock		Kater Ölçüleri (mm) Dimension (mm)				Kesici Uç Insert	Yedek Parçaları Spare Parts			Tork Anahtar Torx Key
	R	L	h	b	L	f		Sıkma Vidası Clamp Screw	Altılık Shim	Altılık Vidası Shim Screw	
SRHCR/L 2525 K10	●	●	25	25	125	25	RC.T 10 T3..	1015-M3.5x9	-	-	80-T15
2525 K12	●	●	25	25	125	25					
2525 K16	●	●	25	25	125	25					
							RC.T 12 04..				
							RC.T 16 06..				

R: Sağ/Right L: Sol/Left ● Stokta/In Stock ○ Stokta Yok/Non Stock Item

Sipariş Örneği/Ordering Example : 1 ad./pcs. SRHCR 2525 K10

S-SİSTEM DIŞ TORNA KATERLERİ

S-SYSTEM EXTERNAL TURNING TOOLHOLDERS

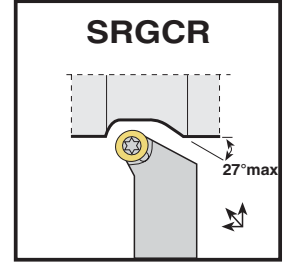
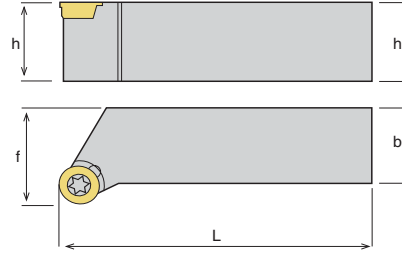

Takım Kodu Ordering Code	Stok Stock		Kater Ölçüleri (mm) Dimension (mm)				Kesici Uç Insert	Yedek Parçaları Spare Parts					
	R	L	h	b	L	f		Sıkma Vidası Clamp Screw	Altlık Shim	Altlık Vidası Shim Screw	Baskı Parçası Wedge Clamp	Baskı Vidası Screw	Tork Anahtar Torx Key
SRGCR/L1616 H 06	○	○	16	16	100	20	RC.T 06 02..	1008-M2.5x7	-	-	-	-	80-T08
2020 K 06	○	○	20	20	125	25							
1616 H 08C	●	●	16	16	100	20	RC.T 08 03..	1008-M3x9	-	-	ACK-15	1015-M3.5x9	80-T15
2020 K 08C	●	●	20	20	125	25							
2525 M08C	●	●	25	25	150	32	RC.T 10 T3..	1015-M3.5x9	-	-	ACK-05	1515-M4x11	80-T15
1616 H 10C	●	●	16	16	100	20							
2020 K 10C	●	●	20	20	125	25	RC.T 12 04..	1015-M3.5x9	-	-	ACK-05	1515-M4x11	80-T15
2525 M10C	●	●	25	25	150	32							
3232 P 10C	●	●	32	32	170	40							
2020 K 12C	●	●	20	20	125	25							
2525 M12C	●	●	25	25	150	32							
3232 P 12C	●	●	32	32	170	40							

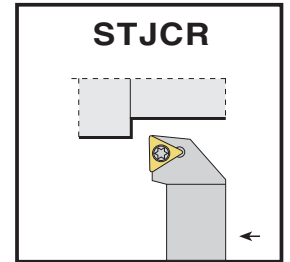
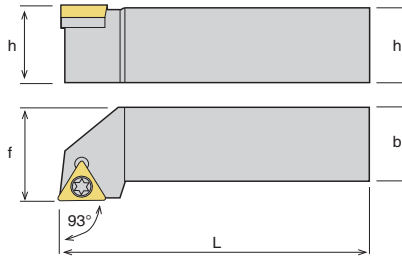

Takım Kodu Ordering Code	Stok Stock		Kater Ölçüleri (mm) Dimension (mm)				Kesici Uç Insert	Yedek Parçaları Spare Parts			
	R	L	h	b	L	f		Sıkma Vidası Clamp Screw	Altlık Shim	Altlık Vidası Shim Screw	Tork Anahtar Torx Key
STJCR/L 0808 E 09	●	●	08	08	70	10	TCM. 09 02..	3007-M2.2x5	-	-	80-T07
1010 E 09	●	●	10	10	70	12					
1212 F 11	●	●	12	12	80	16	TCM. 11 02..	1008-M2.5x7	-	-	80-T08
1616 H 11	●	●	16	16	100	20					
1616 H 16	●	●	16	16	100	20	TCM. 16 T3..	1015-M3.5x14	AATN-2-0001	AAV-06-M3.5x11	80-T15
2020 K 16	●	●	20	20	125	25					
2525 M16	●	●	25	25	150	32					
3232 P 16	●	●	32	32	170	40					

R: Sağ/Right L: Sol/Left ● Stokta/In Stock ○ Stokta Yok/Non Stock Item

Sipariş Örneği/Ordering Example : 1 ad./pcs. STJCR 0808 E09

S-SİSTEM DIŞ TORNA KATERLERİ

S-SYSTEM EXTERNAL TURNING TOOLHOLDERS

91°

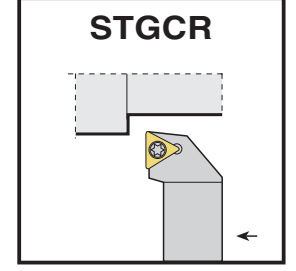
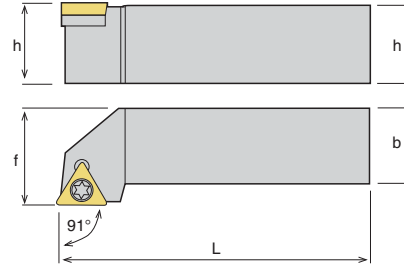

STGCR

Takım Kodu
Ordering Code

Stok
Stock

Kater Ölçüleri (mm)
Dimension (mm)

Kesici Uç
Insert

Yedek Parçaları
Spare Parts

Sıkma Vidası
Clamp Screw

Altık
Shim

Altık Vidası
Shim Screw

Tork Anahtar
Torx Key

R L

h

b

L

f



STGCR/L 0808 E 09

● ●

08

08

70

10

TCM. 09 02..

3007-M2.2x5

-

-

80-T07

1010 E 09

● ●

10

10

70

12

TCM. 11 02..

1008-M2.5x7

-

-

80-T08

1212 F 11

● ●

12

12

80

16

1616 H 11

● ●

16

16

100

20

1616 H 16

○ ○

16

16

100

20

2020 K 16

● ●

20

20

125

25

TCM. 16 T3..

1015-M3.5x14

AATN-2-0001

AAV-06-M3.5x11

80-T15

2525 M 16

● ●

25

25

150

32

3232 P 16

● ●

32

32

170

40

91°

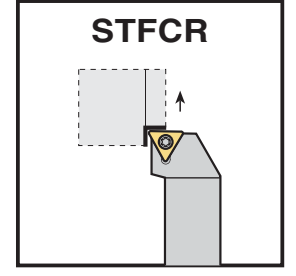
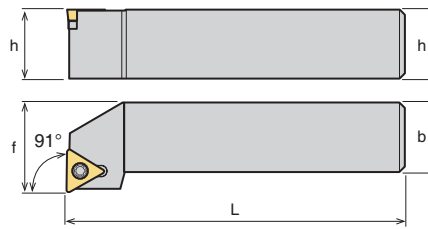

STFCR

Takım Kodu
Ordering Code

Stok
Stock

Kater Ölçüleri (mm)
Dimension (mm)

Kesici Uç
Insert

Yedek Parçaları
Spare Parts

Sıkma Vidası
Clamp Screw

Altık
Shim

Altık Vidası
Shim Screw

Tork Anahtar
Torx Key

R L

h

b

L

f

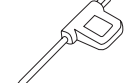

STFCR/L 0808 E 09

○ ○

08

08

70

10

TCM. 09 02..

3007-M2.2x5

-

-

80-T07

1010 E 09

○ ○

10

10

70

12

TCM. 11 02..

1008-M2.5x7

-

-

80-T08

1212 F 11

○ ○

12

12

80

16

1616 H 11

○ ○

16

16

100

20

1616 H 16

● ○

16

16

100

20

2020 K 16

● ○

20

20

125

25

TCM. 16 T3..

1015-M3.5x14

AATN-2-0001

AAV-06-M3.5x11

80-T15

2525 M 16

● ●

25

25

150

32

3232 P 16

○ ○

32

32

170

40

R: Sağ/Right L: Sol/Left ● Stokta/In Stock ○ Stokta Yok/Non Stock Item

Sipariş Örneği/Ordering Example : 1 ad./pcs. STFCR 0808 E09

S-SİSTEM DIŞ TORNA KATERLERİ

S-SYSTEM EXTERNAL TURNING TOOLHOLDERS

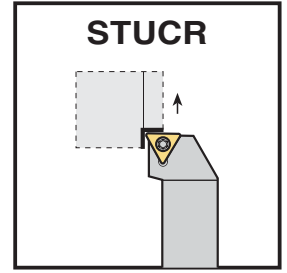
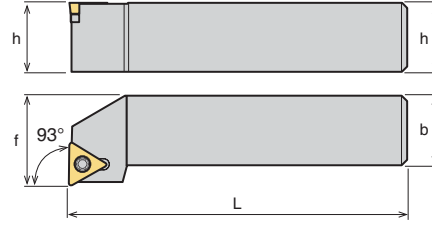

Takım Kodu Ordering Code	Stok Stock		Kater Ölçüleri (mm) Dimension (mm)				Kesici Uç Insert	Yedek Parçaları Spare Parts			
	R	L	h	b	L	f		Sıkma Vidası Clamp Screw	Altlık Shim	Altlık Vidası Shim Screw	Tork Anahtar Torx Key
STUCR/L 0808 E 09	●	●	08	08	70	10					
1010 E 09	●	●	10	10	70	12	TCM. 09 02..	3007-M2.2x5	-	-	80-T07
1212 F 11	●	●	12	12	80	16	TCM. 11 02..	1008-M2.5x7	-	-	80-T08
1616 H 11	●	●	16	16	100	20	TCM. 11 02..	1008-M2.5x7	-	-	80-T08
1616 H 16	○	○	16	16	100	20	TCM. 16 T3..	1015-M3.5x14	AATN-2-0001	AAV-06-M3.5x11	80-T15
2020 K 16	●	●	20	20	125	25	TCM. 16 T3..	1015-M3.5x14	AATN-2-0001	AAV-06-M3.5x11	80-T15
2525 M16	●	●	25	25	150	32	TCM. 16 T3..	1015-M3.5x14	AATN-2-0001	AAV-06-M3.5x11	80-T15
3232 P 16	●	●	32	32	170	40	TCM. 16 T3..	1015-M3.5x14	AATN-2-0001	AAV-06-M3.5x11	80-T15

R: Sağ/Right L: Sol/Left ● Stokta/In Stock ○ Stokta Yok/Non Stock Item

Sipariş Örneği/Ordering Example : 1 ad./pcs. STUCR 0808 E09





P SİSTEM

P SİSTEM DIŞ TORNA KATERLERİ
P SYSTEM EXTERNAL TURNING TOOLHOLDERS

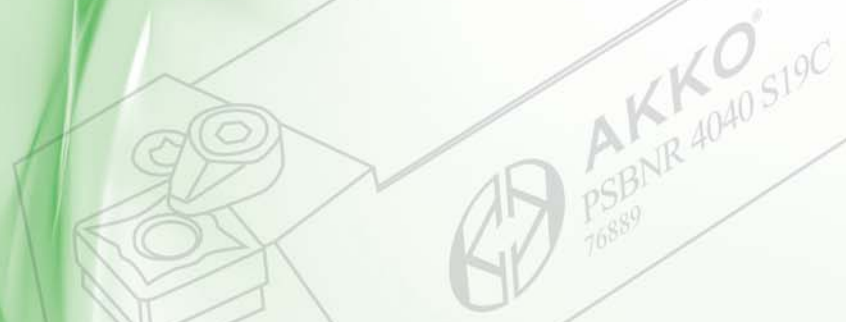

P-SİSTEM DIŞ TORNA KATERLERİ

P-SYSTEM EXTERNAL TURNING TOOLHOLDERS

95 °

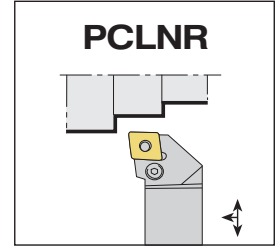
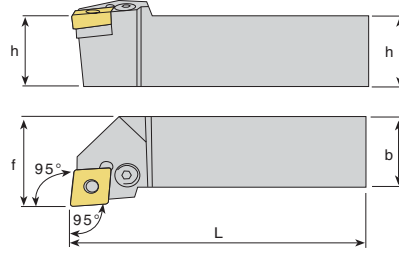

Takım Kodu Ordering Code	Stok Stock		Kater Ölçüleri (mm) Dimension (mm)				Kesici Uç Insert	Yedek Parçaları Spare Parts														
	R	L	h	b	L	f		Levyeye	Levyeye Vidası	Altılık	Altılık Yayı	Baskı Parçası	Baskı Vidası	Anahtar								
								Lever	Lever Screw	Shim	Shim Spring	Wedge Clamp	Screw	Allen Key								
PCLNR/L 1616 H 09	○	○	16	16	100	20																
2020 K 09	○	○	20	20	125	25									CNM. 09 03..	07010909	07010910	07010901	07010911	-	-	AAL-02-2.5
2525 M 09	○	○	25	25	150	32																
1616 H 12C	●	●	16	16	100	20																
2020 K 12C	●	●	20	20	125	25									CNM. 12 04..	APL-02	ALV-03-M8x19	AACN-3-0001	AAY-02	ACK-05	1515-M4x11	AAL-03-3
2525 M 12C	●	●	25	25	150	32																
3232 P 12C	●	●	32	32	170	40																
2525 M 16C	●	●	25	25	150	32									CNM. 16 06..	APL-04	ALV-04-M8x22	AACN-3-0002	AAY-03	ACK-09	AAV-05-M6x15	AAL-05-4
3232 P 16C	●	●	32	32	170	40																
2525 M 19C	●	●	25	25	150	32																
3232 P 19C	●	●	32	32	170	40									CNM. 19 06..	APL-05	ALV-05-M10x27	AACN-3-0003	AAY-04			
4040 S 19C	●	●	40	40	250	50																
4040 S 25C	●	●	40	40	250	50																
5050 S 25C	●	●	50	50	250	60									CNM. 25 09..	APL-06	ALV-06-M12x36	AACN-3-0008	AAY-05	ACK-04	AKV-16-M6x16	AAL-07-5

75 °

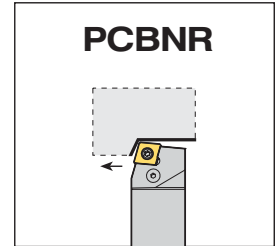
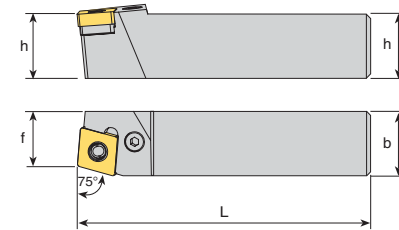

Takım Kodu Ordering Code	Stok Stock		Kater Ölçüleri (mm) Dimension (mm)				Kesici Uç Insert	Yedek Parçaları Spare Parts														
	R	L	h	b	L	f		Levyeye	Levyeye Vidası	Altılık	Altılık Yayı	Baskı Parçası	Baskı Vidası	Anahtar								
								Lever	Lever Screw	Shim	Shim Spring	Wedge Clamp	Screw	Allen Key								
PCBNR/L 2020 K 12C	●	●	20	20	125	25																
2525 M 12C	●	●	25	25	150	32									CNM. 12 04..	APL-02	ALV-03-M8x19	AACN-3-0001	AAY-02	ACK-05	1515-M4x11	AAL-03-3
3232 P 12C	●	●	32	32	170	40																
2525 M 16C	●	●	25	25	150	32																
3232 P 16C	●	●	32	32	170	40									CNM. 16 06..	APL-04	ALV-04-M8x22	AACN-3-0002	AAY-03	ACK-09	AAV-05-M6x15	AAL-05-4
3232 P 19C	●	●	32	32	170	40																
4040 S 19C	●	●	40	40	250	50																
4040 S 25C	●	●	40	40	250	50									CNM. 19 06..	APL-05	ALV-05-M10x27	AACN-3-0003	AAY-04			
5050 S 25C	○	○	50	50	250	60									CNM. 25 09..	APL-06	ALV-06-M12x36	AACN-3-0008	AAY-05	ACK-04	AKV-16-M6x16	AAL-07-5

R: Sağ/Right L: Sol/Left ● Stokta/In Stock ○ Stokta Yok/Non Stock Item

Sipariş Örneği/Ordering Example : 1 ad./pcs. PCBNR 2020 K12C

P-SİSTEM DIŞ TORNA KATERLERİ

P-SYSTEM EXTERNAL TURNING TOOLHOLDERS

50 °

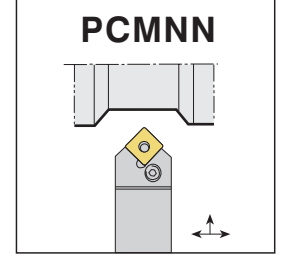
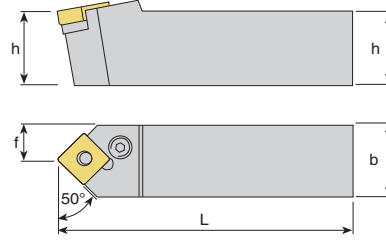

PCMNN

Takım Kodu
Ordering Code

Stok
Stock

Kater Ölçüleri (mm)
Dimension (mm)

Kesici Uç
Insert

Yedek Parçaları
Spare Parts

Levyeye
Lever

Levyeye Vidası
Lever Screw

Aıtlık
Shim

Aıtlık Yayı
Shim Spring

Baskı Parçası
Wedge Clamp

Baskı Vidası
Screw

Anahtar
Allen Key

Takım Kodu Ordering Code	Stok Stock	h	b	L	f	Kesici Uç Insert	Levyeye Lever	Levyeye Vidası Lever Screw	Aıtlık Shim	Aıtlık Yayı Shim Spring	Baskı Parçası Wedge Clamp	Baskı Vidası Screw	Anahtar Allen Key
PCMNN 2020 K 12C	○	20	20	125	10	CNM. 12 04..	APL-02	ALV-03-M8x19	AASN-3-0004	AAV-02	ACK-05	1515-M4x11	AAL-03-3
2525 M 12C	○	25	25	150	12.5								
3232 P 12C	○	32	32	170	16	CNM. 16 06..	APL-04	ALV-04-M8x22	AASN-3-0023	AAV-03	ACK-09	AAV-05-M6x15	AAL-05-4
2525 M 16C	○	25	25	150	12.5								
3232 P 16C	○	32	32	170	16	CNM. 19 06..	APL-05	ALV-05-M10x27	AASN-3-0005	AAV-04			
3232 P 19C	●	32	32	170	16								
4040 S 19C	○	40	40	250	20	CNM. 19 06..	APL-05	ALV-05-M10x27	AASN-3-0005	AAV-04			
5050 S 19C	○	50	50	250	25								

93 °

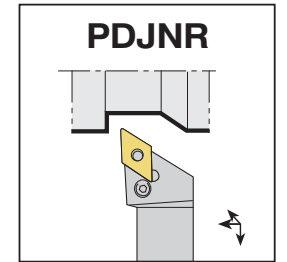
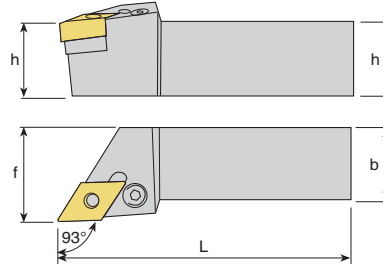

PDJNR

Takım Kodu
Ordering Code

Stok
Stock

Kater Ölçüleri (mm)
Dimension (mm)

Kesici Uç
Insert

Yedek Parçaları
Spare Parts

Levyeye
Lever

Levyeye Vidası
Lever Screw

Aıtlık
Shim

Aıtlık Yayı
Shim Spring

Baskı Parçası
Wedge Clamp

Baskı Vidası
Screw

Anahtar
Allen Key

Takım Kodu Ordering Code	Stok Stock	R	L	h	b	L	f	Kesici Uç Insert	Levyeye Lever	Levyeye Vidası Lever Screw	Aıtlık Shim	Aıtlık Yayı Shim Spring	Baskı Parçası Wedge Clamp	Baskı Vidası Screw	Anahtar Allen Key
PDJNR/L 1616 H 11	●	●		16	16	100	20	DNM. 11 04..	APL-01	ALV-02-M6x17	AADN-SD317	AAV-01	-	-	AAL-02-2.5
2020 K 11	●	●		20	20	125	25								
2525 M 11	●	●		25	25	150	32								
2020 K 15C	●	●		20	20	125	25	DNM. 15 06..	APL-03	ALV-03-M8x19	AADN-3-0001	AAV-02	ACK-05	1515-M4x11	AAL-03-3
2525 M 15C	●	●		25	25	150	32								
3232 P 15C	●	●		32	32	170	40								

R: Sağ/Right L: Sol/Left ● Stokta/In Stock ○ Stokta Yok/Non Stock Item

Sipariş Örneği/Ordering Example : 1 ad./pcs. PDJNR 1616 H11

P-SİSTEM DIŞ TORNA KATERLERİ

P-SYSTEM EXTERNAL TURNING TOOLHOLDERS

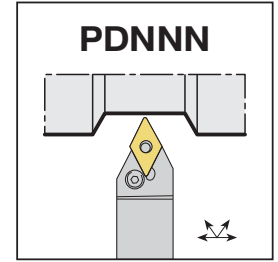
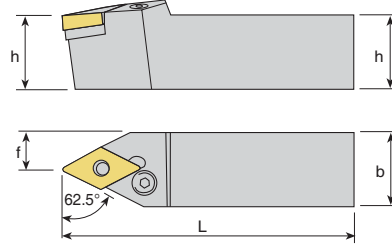

Takım Kodu Ordering Code	Stok Stock	Kater Ölçüleri (mm) Dimension (mm)				Kesici Uç Insert	Yedek Parçaları Spare Parts							
		h	b	L	f		Levyeye Lever	Levyeye Vidası Lever Screw	Altılık Shim	Altılık Yayı Shim Spring	Baskı Parçası Wedge Clamp	Baskı Vidası Screw	Anahtar Allen Key	
PDNN 1616 H 11	●	16	16	100	8									
2020 K 11	●	20	20	125	10		DNM. 11 04..	APL-01	ALV-02-M6x17	AADN-SD317	AAV-01	-	-	AAL-02-2.5
2525 M 11	●	25	25	150	12.5									
2020 K 15C	●	20	20	125	10									
2525 M 15C	●	25	25	150	12.5	DNM. 15 06..	APL-03	ALV-03-M8x19	AADN-3-0001	AAV-02	ACK-05	1515-M4x11	AAL-03-3	
3232 P 15C	●	32	32	170	16									

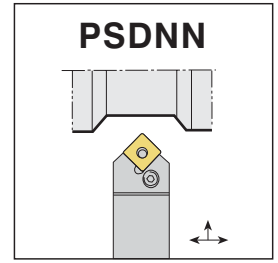
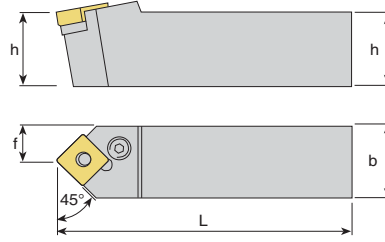

Takım Kodu Ordering Code	Stok Stock	Kater Ölçüleri (mm) Dimension (mm)				Kesici Uç Insert	Yedek Parçaları Spare Parts							
		h	b	L	f		Levyeye Lever	Levyeye Vidası Lever Screw	Altılık Shim	Altılık Yayı Shim Spring	Baskı Parçası Wedge Clamp	Baskı Vidası Screw	Anahtar Allen Key	
PSDNN 1616 H 09	○	16	16	100	8									
2020 K 12C	●	20	20	125	10		SNM. 09 03..	07030909	07030910	07030901	07030911	-	-	AAL-02-2.5
2525 M 12C	●	25	25	150	12.5		SNM. 12 04..	APL-02	ALV-03-M8x19	AASN-3-0004	AAV-02	ACK-05	1515-M4x11	AAL-03-3
3232 P 12C	●	32	32	170	16									
2020 K 15C	○	20	20	125	10	SNM. 15 06..	APL-04	ALV-04-M8x22	AASN-3-0023	AAV-03				
2525 M 15C	○	25	25	150	12.5									
3232 P 19C	●	32	32	170	16						ACK-09	AAV-05-M6x15	AAL-05-4	
4040 S 19C	○	40	40	250	20		SNM. 19 06..	APL-05	ALV-05-M10x27	AASN-3-0005	AAV-04			
5050 S 19C	○	50	50	250	25	SNM. 25 07..	APL-06	ALV-06-M12x36	AASN-3-0020	AAV-05	ACK-04	AKV-16-M6x16	AAL-07-5	
4040 S 25C	○	40	40	250	20									
5050 S 25C	○	50	50	250	25									

R: Sağ/Right L: Sol/Left ● Stokta/In Stock ○ Stokta Yok/Non Stock Item

Sipariş Örneği/Ordering Example : 1 ad./pcs. PSDNN 1616 H09

P-SİSTEM DIŞ TORNA KATERLERİ

P-SYSTEM EXTERNAL TURNING TOOLHOLDERS

75 °

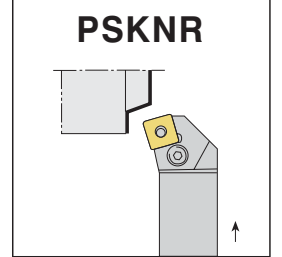
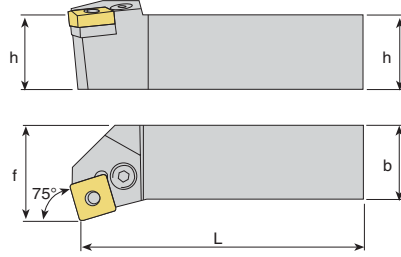

PSKNR

Takım Kodu Ordering Code	Stok Stock		Kater Ölçüleri (mm) Dimension (mm)				Kesici Uç Insert	Yedek Parçaları Spare Parts						
	R	L	h	b	L	f		Levye Lever	Levye Vidası Lever Screw	Aitlik Shim	Aitlik Yayı Shim Spring	Baskı Parçası Wedge Clamp	Baskı Vidası Screw	Anahtar Allen Key
	○	●												
PSKNR/L2020 K 09	○	○	20	20	125	25	SNM. 09 03..	07030909	07030910	07030901	07030911	-	-	AAL-02-2.5
2020 K 12C	●	●	20	20	125	25	SNM. 12 04..	APL-02	ALV-03-M8x19	AASN-3-0004	AAY-02	ACK-05	1515-M4x11	AAL-03-3
2525 M 12C	●	●	25	25	150	32								
3232 P 12C	●	●	32	32	170	40								
2525 M 15C	●	●	25	25	150	32	SNM. 15 06..	APL-04	ALV-04-M8x22	AASN-3-0023	AAY-03	ACK-09	AAV-05-M6x15	AAL-05-4
3232 P 15C	○	○	32	32	170	40								
3232 P 19C	○	○	32	32	170	40	SNM. 19 06..	APL-05	ALV-05-M10x27	AASN-3-0005	AAY-04	ACK-09	AAV-05-M6x15	AAL-05-4
4040 S 19C	○	○	40	40	250	50								
4040 S 25C	○	○	40	40	250	50	SNM. 25 07..	APL-06	ALV-06-M12x36	AASN-3-0020	AAY-05	ACK-04	AKV-16-M6x16	AAL-07-5
5050 S 25C	○	○	50	50	250	60								

45 °

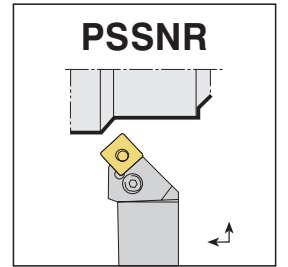
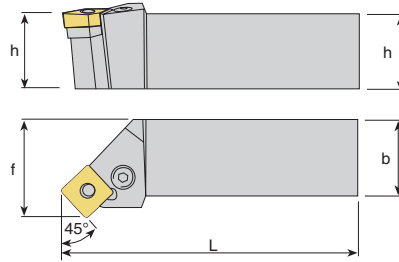

PSSNR

Takım Kodu Ordering Code	Stok Stock		Kater Ölçüleri (mm) Dimension (mm)				Kesici Uç Insert	Yedek Parçaları Spare Parts						
	R	L	h	b	L	f		Levye Lever	Levye Vidası Lever Screw	Aitlik Shim	Aitlik Yayı Shim Spring	Baskı Parçası Wedge Clamp	Baskı Vidası Screw	Anahtar Allen Key
	○	●												
PSSNR/L1616 H 09	○	○	16	16	100	20	SNM. 09 03..	07030909	07030910	07030901	07030911	-	-	AAL-02-2.5
2020 K 09	○	○	20	20	125	25	SNM. 12 04..	APL-02	ALV-03-M8x19	AASN-3-0004	AAY-02	ACK-05	1515-M4x11	AAL-03-3
2020 K 12C	●	●	20	20	125	25								
2525 M 12C	●	●	25	25	150	32								
3232 P 12C	●	●	32	32	170	40	SNM. 15 06..	APL-04	ALV-04-M8x22	AASN-3-0023	AAY-03	ACK-09	AAV-05-M6x15	AAL-05-4
3232 P 15C	○	○	32	32	170	40								
3232 P 19C	●	●	32	32	170	40	SNM. 19 06..	APL-05	ALV-05-M10x27	AASN-3-0005	AAY-04	ACK-09	AAV-05-M6x15	AAL-05-4
4040 S 19C	○	○	40	40	250	50								
4040 S 25C	●	●	40	40	250	50	SNM. 25 07..	APL-06	ALV-06-M12x36	AASN-3-0020	AAY-05	ACK-04	AKV-16-M6x16	AAL-07-5

R: Sağ/Right L: Sol/Left ● Stokta/In Stock ○ Stokta Yok/Non Stock Item

Sipariş Örneği/Ordering Example : 1 ad./pcs. PSSNR 1616 H09

P-SİSTEM DIŞ TORNA KATERLERİ

P-SYSTEM EXTERNAL TURNING TOOLHOLDERS

75°

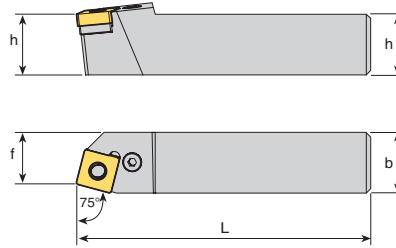

PSBNR

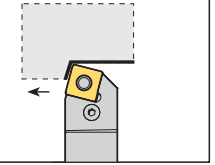

Takım Kodu Ordering Code	Stok Stock		Kater Ölçüleri (mm) Dimension (mm)				Kesici Uç Insert	Yedek Parçaları Spare Parts						
	R	L	h	b	L	f		Levyeye	Levyeye Vidası	Altılık	Altılık Yayı	Baskı Parçası	Baskı Vidası	Anahtar
								Lever	Lever Screw	Shim	Shim Spring	Wedge Clamp	Screw	Allen Key
PSBNR/L 1616 H 09	○	○	16	16	100	20	SNM. 09 03..	07030909	07030910	07030901	07030911	-	-	AAL-02-2.5
2020 K 09	○	○	20	20	125	25								
2020 K 12C	○	○	20	20	125	25	SNM. 12 04..	APL-02	ALV-03-M8x19	AASN-3-0004	AAY-02	ACK-05	1515-M4x11	AAL-03-3
2525 M 12C	●	●	25	25	150	32								
3232 P 12C	○	○	32	32	170	40	SNM. 15 06..	APL-04	ALV-04-M8x22	AASN-3-0023	AAY-03			
2525 M 15C	○	○	25	25	150	32								
3232 P 19C	○	○	32	32	170	40	SNM. 19 06..	APL-05	ALV-05-M10x27	AASN-3-0005	AAY-04	ACK-09	AAV-05-M6x15	AAL-05-4
4040 S 19C	●	●	40	40	250	50								
4040 S 25C	○	○	40	40	250	50	SNM. 25 07..	APL-06	ALV-06-M12x36	AASN-3-0020	AAY-05	ACK-04	AKV-16-M6x16	AAL-07-5
5050 S 25C	○	○	50	50	250	63								

91°

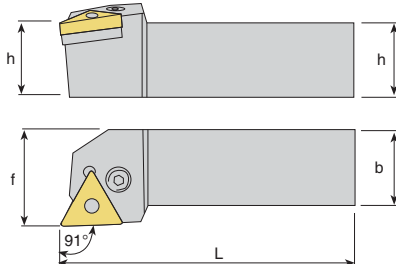

PTGNR

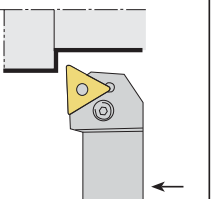

Takım Kodu Ordering Code	Stok Stock		Kater Ölçüleri (mm) Dimension (mm)				Kesici Uç Insert	Yedek Parçaları Spare Parts						
	R	L	h	b	L	f		Levyeye	Levyeye Vidası	Altılık	Altılık Yayı	Baskı Parçası	Baskı Vidası	Anahtar
								Lever	Lever Screw	Shim	Shim Spring	Wedge Clamp	Screw	Allen Key
PTGNR/L 1010 E 11	○	○	10	10	70	12	TNM. 11 03..	07041109	07041110	-	-	-	-	AAL-02-2.5
1212 F 11	○	○	12	12	80	16								
1616 H 11	○	○	16	16	100	20	TNM. 16 04..	APL-01	ALV-02-M6x17	AATN-3-0025	AAY-01	-	-	
1616 H 16	●	●	16	16	100	20								
2020 K 16	●	●	20	20	125	25	TNM. 22 04..	APL-02	ALV-03-M8x19	AATN-3-0015	AAY-02	ACK-05	1515-M4x11	AAL-03-3
2525 M 16	●	●	25	25	150	32								
3232 P 16	○	○	32	32	170	40	TNM. 27 06..	07042709	07042710	07042701	07042711	-	-	AAL-05-4
2525 M 22C	●	●	25	25	150	32								
3232 P 22C	○	○	32	32	170	40								
4040 S 27	○	○	40	40	250	50								

R: Sağ/Right L: Sol/Left ● Stokta/In Stock ○ Stokta Yok/Non Stock Item

Sipariş Örneği/Ordering Example : 1 ad./pcs. PTGNR 1010 E11

P-SİSTEM DIŞ TORNA KATERLERİ

P-SYSTEM EXTERNAL TURNING TOOLHOLDERS

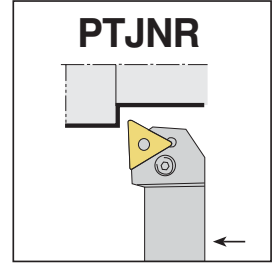
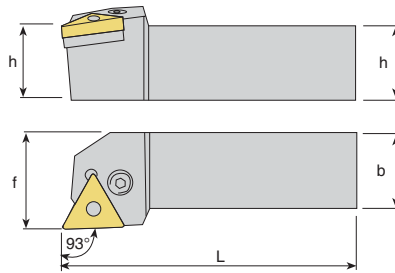

Takım Kodu Ordering Code	Stok Stock		Kater Ölçüleri (mm) Dimension (mm)				Kesici Uç Insert	Yedek Parçaları Spare Parts						
	R	L	h	b	L	f		Levye Lever	Levye Vidası Lever Screw	Altlık Shim	Altlık Yayı Shim Spring	Baskı Parçası Wedge Clamp	Baskı Vidası Screw	Anahtar Allen Key
PTJNR/L 1010 E 11	○	○	10	10	70	12	TNM. 11 03..	07041109	07041110	-	-	-	-	-
1212 F 11	○	○	12	12	80	16								
1616 H 11	○	○	16	16	100	20								
1616 H 16	●	●	16	16	100	20	TNM. 16 04..	APL-01	ALV-02-M6x17	AATN-3-0025	AAY-01	-	-	AAL-02-2.5
2020 K 16	●	●	20	20	125	25								
2525 M16	●	●	25	25	150	32								
3232 P 16	●	●	32	32	170	40								
2525 M22C	●	●	25	25	150	32	TNM. 22 04..	APL-02	ALV-03-M8x19	AATN-3-0015	AAY-02	ACK-05	1515-M4x11	AAL-03-3
3232 P 22C	●	●	32	32	170	40								
4040 S 27	○	○	40	40	250	50	TNM. 27 06..	07042709	07042710	07042701	07042711	-	-	AAL-05-4

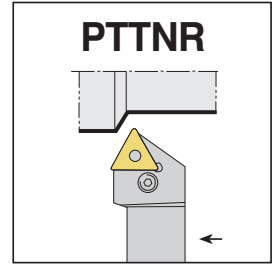
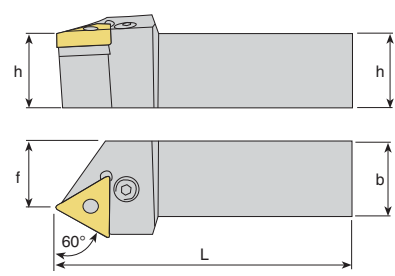

Takım Kodu Ordering Code	Stok Stock		Kater Ölçüleri (mm) Dimension (mm)				Kesici Uç Insert	Yedek Parçaları Spare Parts						
	R	L	h	b	L	f		Levye Lever	Levye Vidası Lever Screw	Altlık Shim	Altlık Yayı Shim Spring	Baskı Parçası Wedge Clamp	Baskı Vidası Screw	Anahtar Allen Key
PTTNR/L1616 H 16	●	●	16	16	100	13	TNM. 16 04..	APL-01	ALV-02-M6x17	AATN-3-0025	AAY-01	-	-	AAL-02-2.5
2020 K 16	●	●	20	20	125	17								
2525 M16	●	●	25	25	150	21.5								
3232 P 16	●	●	32	32	170	31								
2525 M22C	●	●	25	25	150	20.5	TNM. 22 04..	APL-02	ALV-03-M8x19	AATN-3-0015	AAY-02	ACK-05	1515-M4x11	AAL-03-3
3232 P 22C	●	●	32	32	170	29								

R: Sağ/Right L: Sol/Left ● Stokta/In Stock ○ Stokta Yok/Non Stock Item

Sipariş Örneği/Ordering Example : 1 ad./pcs. PTTNR 1616 H16

P-SİSTEM DIŞ TORNA KATERLERİ

P-SYSTEM EXTERNAL TURNING TOOLHOLDERS

91°

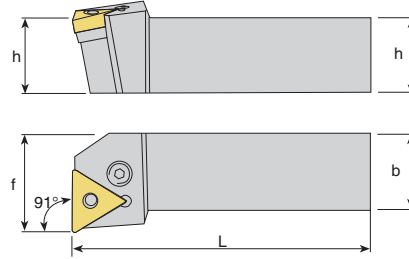
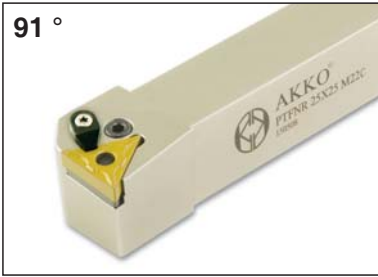

PTFNR

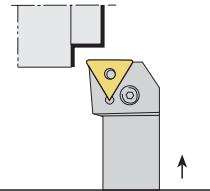

Takım Kodu Ordering Code	Stok Stock		Kater Ölçüleri (mm) Dimension (mm)				Kesici Uç Insert	Yedek Parçaları Spare Parts						
	R	L	h	b	L	f		Levyeye	Levyeye Vidası	Altılık	Altılık Yayı	Baskı Parçası	Baskı Vidası	Anahtar
								Lever	Lever Screw	Shim	Shim Spring	Wedge Clamp	Screw	Allen Key
PTFNR/L 1616 H 16	●	●	16	16	100	20	TNM. 16 04..	APL-01	ALV-02-M6x17	AATN-3-0025	AAY-01	-	-	AAL-02-2.5
2020 K 16	●	●	20	20	125	25								
2525 M16	●	●	25	25	150	32								
3232 P 16	●	●	32	32	170	40								
2525 M22C	●	●	25	25	150	32	TNM. 22 04..	APL-02	ALV-03-M8x19	AATN-3-0015	AAY-02	ACK-05	1515-M4x11	AAL-03-3
3232 P 22C	●	●	32	32	170	40								
4040 S 27	○	○	40	40	250	50								
							TNM. 27 06..	07042709	07042710	07042701	07042711	-	-	AAL-05-4

95°

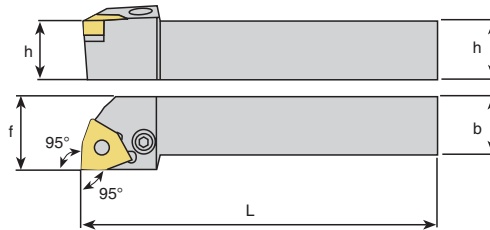

PWLNR

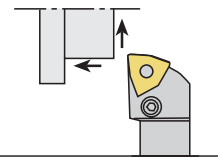

Takım Kodu Ordering Code	Stok Stock		Kater Ölçüleri (mm) Dimension (mm)				Kesici Uç Insert	Yedek Parçaları Spare Parts						
	R	L	h	b	L	f		Levyeye	Levyeye Vidası	Altılık	Altılık Yayı	Baskı Parçası	Baskı Vidası	Anahtar
								Lever	Lever Screw	Shim	Shim Spring	Wedge Clamp	Screw	Allen Key
PWLNR/L 1616 H 06	○	○	16	16	100	20	WNM. 06 04..	APL-01	ALV-02-M6x17	AAWN-SW317	AAY-01	-	-	AAL-02-2.5
2020 K 06	○	○	20	20	125	25								
2525 M06	○	○	25	25	150	32								
3232 P 06	○	○	32	32	170	40								
1616 H 08	●	●	16	16	100	20	WNM. 08 04..	APL-02	ALV-03-M8x19	AAWN-3-0001	AAY-02	ACK-05	1515-M4x11	AAL-03-3
2020 K 08C	●	●	20	20	125	25								
2525 M08C	●	●	25	25	150	32								
3232 P 08C	●	●	32	32	170	40								

R: Sağ/Right L: Sol/Left ● Stokta/In Stock ○ Stokta Yok/Non Stock Item

Sipariş Örneği/Ordering Example : 1 ad./pcs. PWLNR 1616 H06



C SISTEM

C-SISTEM DIŞ TORNA KATERLERİ
C SYSTEM EXTERNAL TURNING TOOLHOLDERS



C-SİSTEM SERAMİK UÇLAR İÇİN DIŞ TORNA KATERLERİ

C-SYSTEM EXTERNAL TURNING TOOLHOLDERS FOR CERAMIC INSERTS

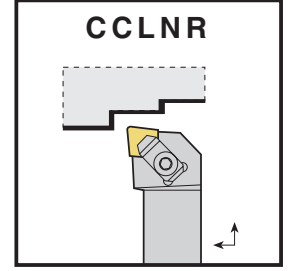
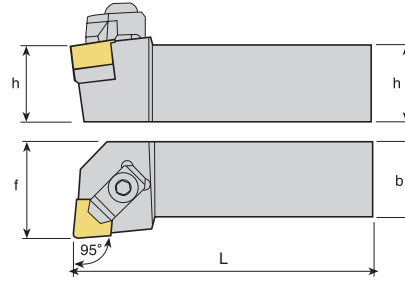

Takım Kodu Ordering Code	Stok Stock		Kater Ölçüleri (mm) Dimension (mm)				Kesici Uç Insert	Yedek Parçaları Spare Parts					
	R	L	h	b	L	f		Baskı Parçası Wedge Clamp	Baskı Vidası Screw	Altık Shim	Altık Vidası Shim Screw	Sekman Ring	Anahtar Allen Key
CCLNR/L 2525 M1207C	●	●	25	25	150	32	CN.N 1207..	ACK-13	AKV-11-M8x33	AACN-3-0001	AAV-02-M5x12	ACS-01	AAL-05-4
3232 P1207C	●	●	32	32	170	40							

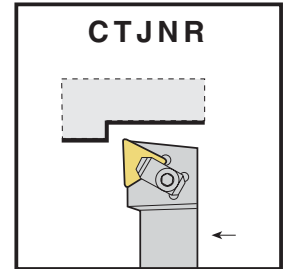
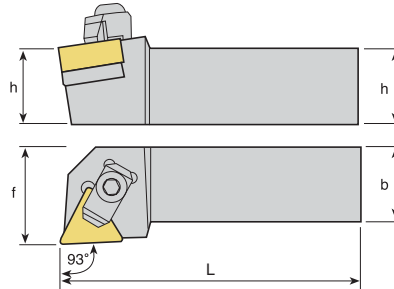

Takım Kodu Ordering Code	Stok Stock		Kater Ölçüleri (mm) Dimension (mm)				Kesici Uç Insert	Yedek Parçaları Spare Parts					
	R	L	h	b	L	f		Baskı Parçası Wedge Clamp	Baskı Vidası Screw	Altık Shim	Altık Vidası Shim Screw	Sekman Ring	Anahtar Allen Key
CTJNR/L 2525 M1607C	●	●	25	25	150	32	TN.N 1607..	ACK-14	AKV-11-M8x33	AATN-2-0002	AAV-03-M5x12	ACS-01	AAL-05-4
3232 P1607C	○	○	32	32	170	40							

R: Sağ/Right L: Sol/Left ● Stokta/In Stock ○ Stokta Yok/Non Stock Item

Sipariş Örneği/Ordering Example : 1 ad./pcs. CTJNR 2525 M1607C

C-SİSTEM SERAMİK UÇLAR İÇİN DIŞ TORNA KATERLERİ

C-SYSTEM EXTERNAL TURNING TOOLHOLDERS FOR CERAMIC INSERTS

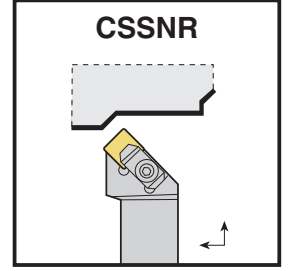
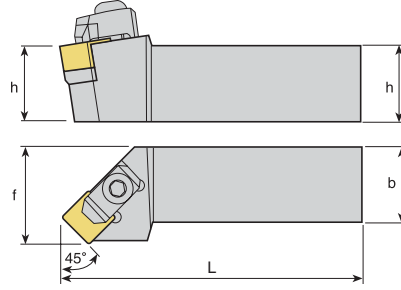

Takım Kodu Ordering Code	Stok Stock		Kater Ölçüleri (mm) Dimension (mm)				Kesici Uç Insert	Yedek Parçaları Spare Parts					
	R	L	h	b	L	f		Baskı Parçası Wedge Clamp	Baskı Vidası Screw	Altılık Shim	Altılık Vidası Shim Screw	Sekman Ring	Anahtar Allen Key
	CSSNR/L 2525 M1207C	●	●	25	25	150		32	SN.N 1207..	ACK-13	AKV-11-M8x33	AASN-3-0004	AAV-02-M5x12
3232 P1207C	●	●	32	32	170	40							

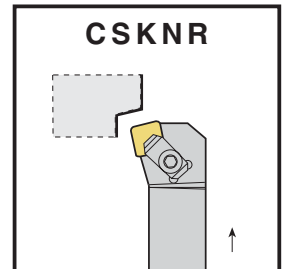
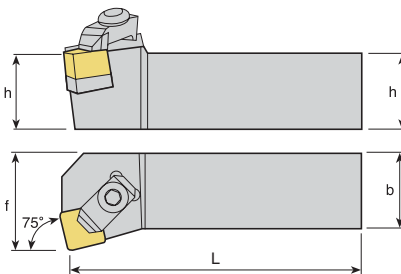

Takım Kodu Ordering Code	Stok Stock		Kater Ölçüleri (mm) Dimension (mm)				Kesici Uç Insert	Yedek Parçaları Spare Parts					
	R	L	h	b	L	f		Baskı Parçası Wedge Clamp	Baskı Vidası Screw	Altılık Shim	Altılık Vidası Shim Screw	Sekman Ring	Anahtar Allen Key
	CSKNR/L 2525 M1207C	●	●	25	25	150		32	SN.N 1207..	ACK-13	AKV-11-M8x33	AASN-3-0004	AAV-02-M5x12
3232 P1207C	●	●	32	32	170	40							

R: Sağ/Right L: Sol/Left ● Stokta/In Stock ○ Stokta Yok/Non Stock Item

Sipariş Örneği/Ordering Example : 1 ad./pcs. CSKNR 2525 M1207C

C-SİSTEM SERAMİK UÇLAR İÇİN DIŞ TORNA KATERLERİ

C-SYSTEM EXTERNAL TURNING TOOLHOLDERS FOR CERAMIC INSERTS

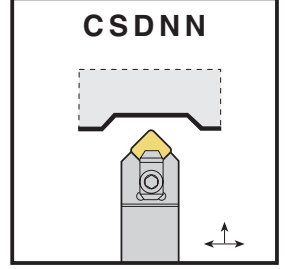
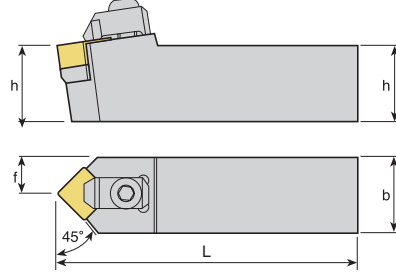

Takım Kodu Ordering Code	Stok Stock		Kater Ölçüleri (mm) Dimension (mm)				Kesici Uç Insert	Yedek Parçaları Spare Parts					
	R	L	h	b	L	f		Baskı Parçası Wedge Clamp	Baskı Vidası Screw	Altık Shim	Altık Vidası Shim Screw	Sekman Ring	Anahtar Allen Key
CSDNN 2525 M1207C	●		25	25	150	12.5	SN.N 1207..	ACK-13	AKV-11-M8x33	AASN-3-0004	AAV-02-M5x12	ACS-01	AAL-05-4
3232 P1207C		●	32	32	170	16							

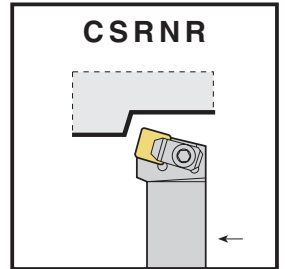
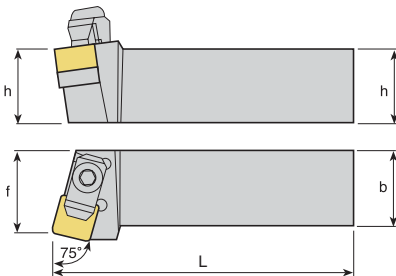

Takım Kodu Ordering Code	Stok Stock		Kater Ölçüleri (mm) Dimension (mm)				Kesici Uç Insert	Yedek Parçaları Spare Parts					
	R	L	h	b	L	f		Baskı Parçası Wedge Clamp	Baskı Vidası Screw	Altık Shim	Altık Vidası Shim Screw	Sekman Ring	Anahtar Allen Key
CSRNR/L 2525 M1207C	○	●	25	25	150	32	SN.N 1207..	ACK-13	AKV-11-M8x33	AASN-3-0004	AAV-02-M5x12	ACS-01	AAL-05-4
3232 P1207C	●	○	32	32	170	40							

R: Sağ/Right L: Sol/Left ● Stokta/In Stock ○ Stokta Yok/Non Stock Item

Sipariş Örneği/Ordering Example : 1 ad./pcs. CSRNL 2525 M1207C

C-SİSTEM SERAMİK UÇLAR İÇİN DIŞ TORNA KATERLERİ

C-SYSTEM EXTERNAL TURNING TOOLHOLDERS FOR CERAMIC INSERTS

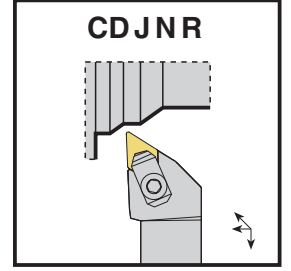
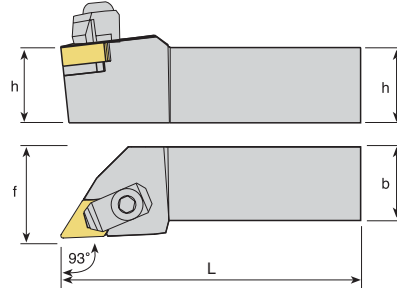

Takım Kodu Ordering Code	Stok Stock		Kater Ölçüleri (mm) Dimension (mm)				Kesici Uç Insert	Yedek Parçaları Spare Parts					
	R	L	h	b	L	f		Baskı Parçası Wedge Clamp	Baskı Vidası Screw	Altık Shim	Altık Vidası Shim Screw	Sekman Ring	Anahtar Allen Key
CDJNR/L 2525 M1507C	●	●	25	25	150	32	DN.N 1507..	ACK-13	AKV-11-M8x33	AADN-3-0001	AAV-02-M5x12	ACS-01	AAL-05-4
3232 P1507C	●	●	32	32	170	40							

C-SİSTEM DIŞ TORNA KATERLERİ

C-SYSTEM EXTERNAL TURNING TOOLHOLDERS

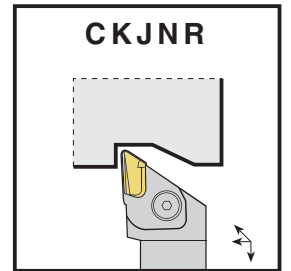
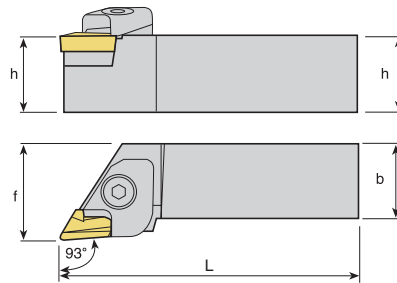

Takım Kodu Ordering Code	Stok Stock		Kater Ölçüleri (mm) Dimension (mm)				Kesici Uç Insert	Yedek Parçaları Spare Parts						
	R	L	h	b	L	f		Baskı Parçası Wedge Clamp	Baskı Vidası Screw	Altık Shim	Altık Vidası Shim Screw	Yay Spring	Pul Stamp	Anahtar Allen Key
CKJNR/L 2020 K 16	●	●	20	20	125	25	KNUX 16 04..	ACK-01-R ACK-02-L	AKV-06-M6x20	AKS-16-R AKS-16-L	AAV-01-M3x10	AKY-02	ABPL-01	AAL-05-4
2525 M16	●	●	25	25	150	32								
3232 P 16	●	●	32	32	170	40								
4040 S 16	●	○	40	40	250	50								

R: Sağ/Right L: Sol/Left ● Stokta/In Stock ○ Stokta Yok/Non Stock Item

Sipariş Örneği/Ordering Example : 1 ad./pcs. CKJNR 2020 K16

INTERNAL TURNING TOOLHOLDERS

KESİCİ UÇ BAĞLAMA SİSTEMLERİ

CONNECTION SYSTEMS FOR CUTTING INSERTS



DELİK TORNA TAKIMLARI

INTERNAL TURNING TOOLHOLDERS

DELİK TORNA

S
1

25
2

S
3

P
4

C
5

L
6

N
7

R
8

12
9

C
10

1 Takım Malzemesi / Type of Boring Bar

"A" Yekpare çelik gövde soğutma suyu kanallı / "A" Solid steel with coolant hole
 "E" Çelik başlıkla sert metal gövde ve soğutma suyu kanallı /
 "E" Carbide bar with fixed steel head and coolant hole
 "C" Karbür Şaft / "C" Carbide shank
 "S" Çelik Şaft / "S" Steel shank

2 Şaft Çapı / Shank Diameter

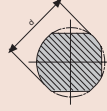

3 Şaft Boyu / Shank Length

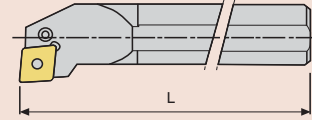

			(mm)
A-32	H-100	Q-180	x-special
B-40	J-110	R-200	
C-50	K-125	S-250	
D-60	L-140	T-300	
E-70	M-150	U-350	
F-80	N-160	V-400	
G-90	P-170	W-450	

4 Sıkma Tipi / Method of Mounting of Insert

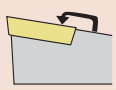

Deliksiz Üstten Sıkma
Top clamping without hole

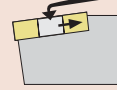
C

Üstten Delikle Sıkma
Top and Hole Clamping

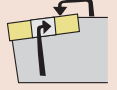
T

Üstten ve Delikten Sıkma
Top and Hole Clamping

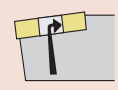
M

Delikten Laveye ile Sıkma
Hole Clamping (Lever Lock)

P

Vida ile Sıkma
Screw on

S

5 Uç Tipi / Insert Shape

C

D

E

V

R

S

W

K

T

6 Yanaşma Açısı / Tool Holder Shape Bar Geometry

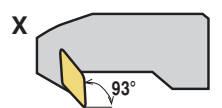
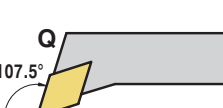
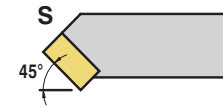
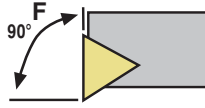
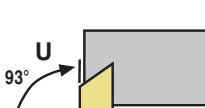
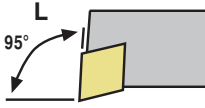

7 Serbest Uç Açısı / Insert Clearance Angle

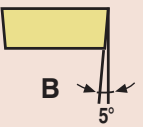
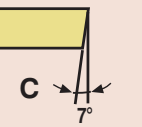
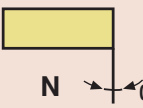

B

C

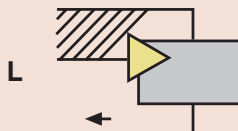
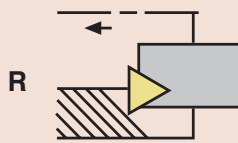
N

P

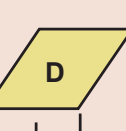
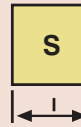
8 Kesme Yönü / Cutting Direction



9 Kesme Kenar Uzunluğu / Cutting Edge Length



9 Baskı Pabucu / Wedge Clamp

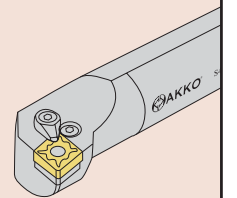



T&C SISTEM

T&C SISTEM DELİK TORNA KATERLERİ
T&C SYSTEM BORING BARS

T&C SISTEM DELİK TORNA KATERLERİ
T&C SYSTEM BORING BARS



T-SİSTEM DELİK TORNA KATERLERİ

T-SYSTEM BORING BARS

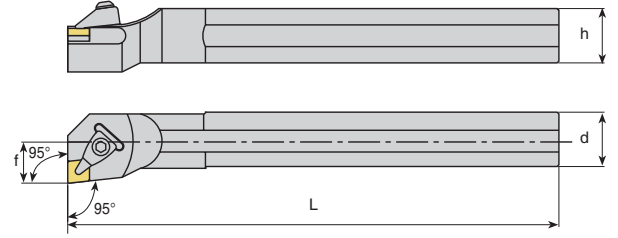

Takım Kodu Ordering Code	Stok Stock		Kater Ölçüleri (mm) Dimension (mm)					Kesici Uç Insert	Yedek Parçaları Spare Parts						
	R	L	d	h	L	f	D min		Baskı Parçası Wedge Clamp	Baskı Vidası Screw	Altlık Shim	Altlık Vidası Shim Screw	Yay Spring	Pul Stamp	Anahtar Allen Key
S25S TCLNR/L 09	●	●	25	23	250	17	ø32	CNM. 09 03..	ATK-01	AKV-01-M5x20	AACN-2-0001	AAV-04-M5x12	-	ABPL-01	AAL-03-3
S25S TCLNR/L 12	●	●	25	23	250	17	ø32		ATK-02	AKV-02-M6x20	AACN-3-0001	AAV-02-M5x12	AKY-01		
S32T TCLNR/L 12	●	●	32	30	300	22	ø40	CNM. 12 04..	ATK-02	AKV-02-M6x20	AACN-3-0001	AAV-02-M5x12	AKY-01	ABPL-01	AAL-03-3
S40U TCLNR/L 12	●	●	40	37	350	27	ø50		ATK-02	AKV-02-M6x20	AACN-3-0001	AAV-02-M5x12	AKY-01		
S50V TCLNR/L 12	●	●	50	47	400	35	ø63	CNM. 16 06..	ATK-04	AKV-05-M6x25	AACN-3-0002	AAV-05-M6x15	-	-	AAL-05-4
S32T TCLNR/L 16	●	●	32	30	300	22	ø40		ATK-04	AKV-05-M6x25	AACN-3-0002	AAV-05-M6x15	-		
S40U TCLNR/L 16	●	●	40	37	350	27	ø50	CNM. 16 06..	ATK-04	AKV-05-M6x25	AACN-3-0002	AAV-05-M6x15	-	-	AAL-05-4
S50V TCLNR/L 16	●	●	50	47	400	35	ø63		ATK-04	AKV-05-M6x25	AACN-3-0002	AAV-05-M6x15	-		

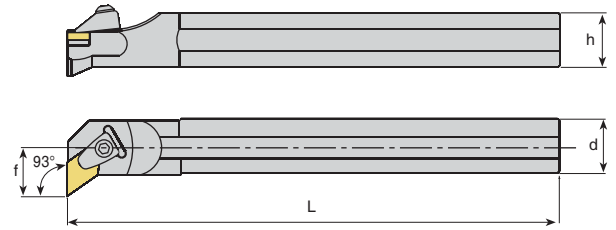

Takım Kodu Ordering Code	Stok Stock		Kater Ölçüleri (mm) Dimension (mm)					Kesici Uç Insert	Yedek Parçaları Spare Parts						
	R	L	d	h	L	f	D min		Baskı Parçası Wedge Clamp	Baskı Vidası Screw	Altlık Shim	Altlık Vidası Shim Screw	Yay Spring	Pul Stamp	Anahtar Allen Key
S25S TDUNR/L 11	●	●	25	23	250	17	ø32	DNM. 11 04..	ATK-01	AKV-01-M5x20	AADN-2-0001	AAV-04-M5x12	-	ABPL-01	AAL-03-3
S32T TDUNR/L 11	●	●	32	30	300	22	ø40		ATK-02	AKV-02-M6x20	AADN-3-0001	AAV-02-M5x12	AKY-01		
S25S TDUNR/L 15	●	●	25	23	250	17	ø32	DNM. 15 06..	ATK-01	AKV-01-M5x20	AADN-2-0001	AAV-04-M5x12	-	ABPL-01	AAL-03-3
S32T TDUNR/L 15	●	●	32	30	300	22	ø40		ATK-02	AKV-02-M6x20	AADN-3-0001	AAV-02-M5x12	AKY-01		
S40U TDUNR/L 15	●	●	40	37	350	27	ø50	DNM. 15 06..	ATK-02	AKV-02-M6x20	AADN-3-0001	AAV-02-M5x12	AKY-01	ABPL-01	AAL-03-3
S50V TDUNR/L 15	●	●	50	47	400	35	ø63		ATK-02	AKV-02-M6x20	AADN-3-0001	AAV-02-M5x12	AKY-01		

R: Sağ/Right L: Sol/Left ● Stokta/In Stock ○ Stokta Yok/Non Stock Item

Sipariş Örneği/Ordering Example : 1 ad./pcs. S25S TDUNR 11

T-SİSTEM DELİK TORNA KATERLERİ

T-SYSTEM BORING BARS

62.5°

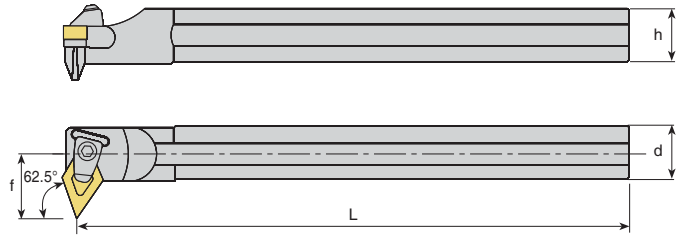

Takım Kodu Ordering Code	Stok Stock		Kater Ölçüleri (mm) Dimension (mm)				Kesici Uç Insert	Yedek Parçaları Spare Parts							
	R	L	d	h	L	f		D min	Baskı Parçası Wedge Clamp	Baskı Vidası Screw	Altlık Shim	Altlık Vidası Shim Screw	Yay Spring	Pul Stamp	Anahtar Allen Key
S32T TD-NR/L 15	●	●	32	30	300	26	∅44	DNM. 15 06..							
S40U TD-NR/L 15	●	●	40	37	350	29	∅52		ATK-02	AKV-02-M6x20	AADN-3-0001	AAV-02-M5x12	AKY-01	ABPL-01	AAL-03-3
S50V TD-NR/L 15	●	●	50	47	400	35	∅67								

107.5°

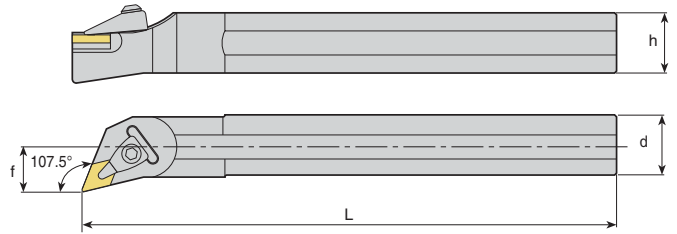

Takım Kodu Ordering Code	Stok Stock		Kater Ölçüleri (mm) Dimension (mm)				Kesici Uç Insert	Yedek Parçaları Spare Parts							
	R	L	d	h	L	f		D min	Baskı Parçası Wedge Clamp	Baskı Vidası Screw	Altlık Shim	Altlık Vidası Shim Screw	Yay Spring	Pul Stamp	Anahtar Allen Key
S25S TDQNR/L 11	●	●	25	23	250	17	∅32	DNM. 11 04..					-		
S32T TDQNR/L 11	●	●	32	30	300	22	∅40		ATK-01	AKV-01-M5x20	AADN-2-0001	AAV-04-M5x12			
S32T TDQNR/L 15	●	●	32	30	300	22	∅40							ABPL-01	AAL-03-3
S40U TDQNR/L 15	●	●	40	37	350	27	∅50	DNM. 15 06..							
S50V TDQNR/L 15	●	●	50	47	400	35	∅63		ATK-02	AKV-02-M6x20	AADN-3-0001	AAV-02-M5x12	AKY-01		

R: Sağ/Right L: Sol/Left ● Stokta/In Stock ○ Stokta Yok/Non Stock Item

Sipariş Örneği/Ordering Example : 1 ad./pcs. S25S TDQNR 11

T-SİSTEM DELİK TORNA KATERLERİ

T-SYSTEM BORING BARS

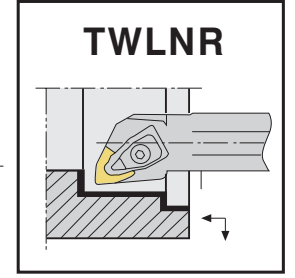
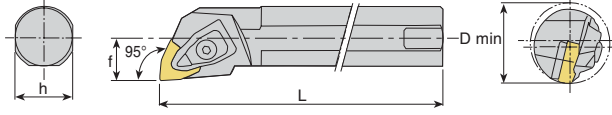

Takım Kodu Ordering Code	Stok Stock		Kater Ölçüleri (mm) Dimension (mm)					Kesici Uç Insert	Yedek Parçaları Spare Parts						
	R	L	d	h	L	f	D min		Baskı Parçası Wedge Clamp	Baskı Vidası Screw	Altlık Shim	Altlık Vidası Shim Screw	Yay Spring	Pul Stamp	Anahtar Allen Key
S25S TWLNR/L 06	●	●	25	23	250	17	ø32	WNM. 06 04..	ATK-01	AKV-01-M5x20	AAWN-SW317	AAV-01-M3x10	-	ABPL-01	AAL-03-3
S32T TWLNR/L 06	●	●	32	30	300	22	ø40								
S25S TWLNR/L 08	●	●	25	23	250	17	ø32	WNM. 08 04..	ATK-02	AKV-02-M6x20	AAWN-3-0001	AAV-02-M5x12	AKY-01	ABPL-01	AAL-03-3
S32T TWLNR/L 08	●	●	32	30	300	22	ø40								
S40U TWLNR/L 08	●	●	40	37	350	27	ø50								
S50V TWLNR/L 08	●	●	50	47	400	35	ø63								

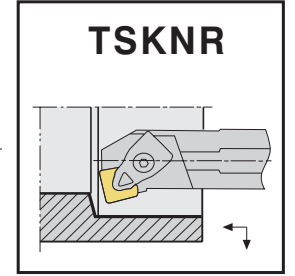
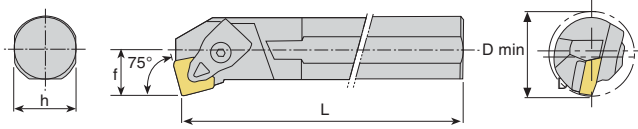

Takım Kodu Ordering Code	Stok Stock		Kater Ölçüleri (mm) Dimension (mm)					Kesici Uç Insert	Yedek Parçaları Spare Parts						
	R	L	d	h	L	f	D min		Baskı Parçası Wedge Clamp	Baskı Vidası Screw	Altlık Shim	Altlık Vidası Shim Screw	Yay Spring	Pul Stamp	Anahtar Allen Key
S25S TSKNR/L 12	●	●	25	23	250	17	ø32	SNM. 12 04..	ATK-02	AKV-02-M6x20	AASN-3-0004	AAV-02-M5x12	AKY-01	ABPL-01	AAL-03-3
S32T TSKNR/L 12	●	●	32	30	300	22	ø40								
S40U TSKNR/L 12	●	●	40	37	350	27	ø50								

R: Sağ/Right L: Sol/Left ● Stokta/In Stock ○ Stokta Yok/Non Stock Item

Sipariş Örneği/Ordering Example : 1 ad./pcs. S25S TSKNR 12

T-SİSTEM DELİK TORNA KATERLERİ

T-SYSTEM BORING BARS

93°

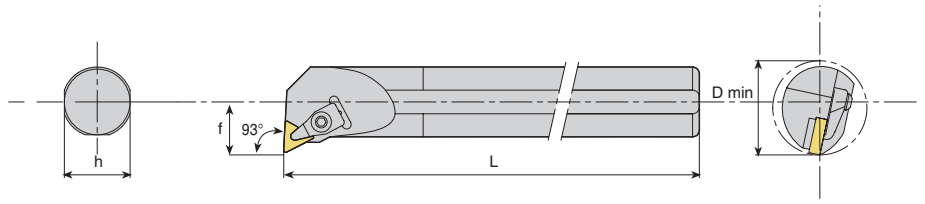

Takım Kodu Ordering Code	Stok Stock		Kater Ölçüleri (mm) Dimension (mm)				Kesici Uç Insert	Yedek Parçaları Spare Parts							
	R	L	d	h	L	f		D min	Baskı Parçası Wedge Clamp	Baskı Vidası Screw	Altılık Shim	Altılık Vidası Shim Screw	Yay Spring	Pul Stamp	Anahtar Allen Key
S25S TTUNR/L 16	●	●	25	23	250	17	32	TNM. 16 04..	ATK-01	AKV-01-M5x20	AATN-2-0002	AAV-03-M5x12	-	ABPL-01	AAL-03-3
S32T TTUNR/L 16	●	●	32	30	300	22	40								
S32T TTUNR/L 22	○	○	32	30	300	22	40	TNM. 22 04..	ATK-02	AKV-02-M6x20	AATN-3-0015	AAV-02-M5x12	AKY-01	ABPL-01	AAL-03-3
S40U TTUNR/L 22	●	●	40	37	350	27	50								
S50V TTUNR/L 22	●	●	50	47	400	35	63								

60°

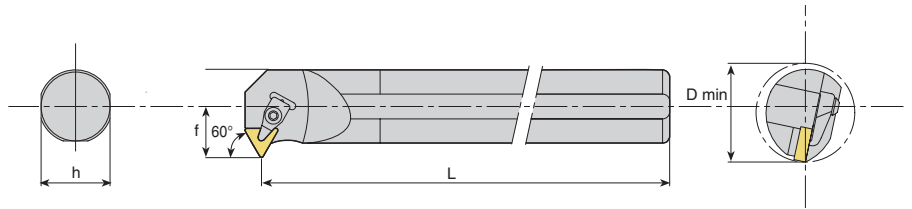

Takım Kodu Ordering Code	Stok Stock		Kater Ölçüleri (mm) Dimension (mm)				Kesici Uç Insert	Yedek Parçaları Spare Parts							
	R	L	d	h	L	f		D min	Baskı Parçası Wedge Clamp	Baskı Vidası Screw	Altılık Shim	Altılık Vidası Shim Screw	Yay Spring	Pul Stamp	Anahtar Allen Key
S25S TT-NR/L 16	●	●	25	23	250	17	32	TNM. 16 04..	ATK-01	AKV-01-M5x20	AATN-2-0002	AAV-03-M5x12	-	ABPL-01	AAL-03-3
S32T TT-NR/L 16	●	●	32	30	300	22	40								

R: Sağ/Right L: Sol/Left ● Stokta/In Stock ○ Stokta Yok/Non Stock Item

Sipariş Örneği/Ordering Example : 1 ad./pcs. S25S TT-NR 16

T-SİSTEM DELİK TORNA KATERLERİ

T-SYSTEM BORING BARS

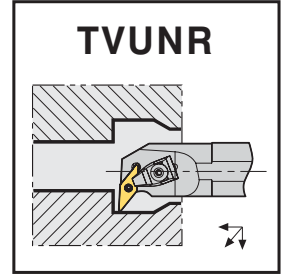
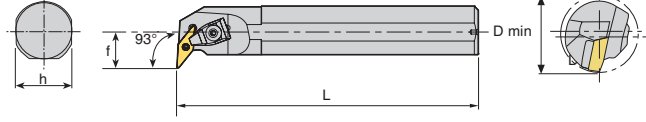

Takım Kodu Ordering Code	Stok Stock		Kater Ölçüleri (mm) Dimension (mm)					Kesici Uç Insert	Yedek Parçaları Spare Parts													
	R	L	d	h	L	f	D min		Baskı Parçası Wedge Clamp	Baskı Vidası Screw	Altık Shim	Altık Vidası Shim Screw	Yay Spring	Pul Stamp	Anahtar Allen Key							
S25S TVUNR/L 16	●	○	25	23	250	17	32															
S32T TVUNR/L 16	●	○	32	30	300	22	VNM. 16 04..									ATK-01	AKV-01-M5x20	AAVN-2-0002	AAV-04-M5x12	-	ABPL-01	AAL-03-3
S40U TVUNR/L 16	●	○	40	37	350	27	350															

C-SİSTEM DELİK TORNA KATERLERİ

C-SYSTEM BORING BARS

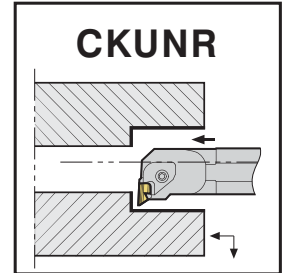
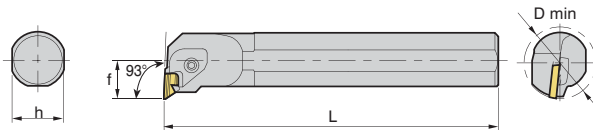

Takım Kodu Ordering Code	Stok Stock		Kater Ölçüleri (mm) Dimension (mm)					Kesici Uç Insert	Yedek Parçaları Spare Parts						
	R	L	d	h	L	f	D min		Baskı Parçası Wedge Clamp	Baskı Vidası Screw	Altık Shim	Altık Vidası Shim Screw	Yay Spring	Pul Stamp	Anahtar Allen Key
S25S CKUNR/L 16	●	●	25	23	250	19	34								
S32T CKUNR/L 16	●	●	32	30	300	22	340								
S40U CKUNR/L 16	●	●	40	37	350	27	350								
S50V CKUNR/L 16	●	●	50	47	400	35	363								

R: Sağ/Right L: Sol/Left ● Stokta/In Stock ○ Stokta Yok/Non Stock Item

Sipariş Örneği/Ordering Example : 1 ad./pcs. S25S CKUNR 16



M SİSTEM

M SİSTEM DELİK TORNA KATERLERİ
M SYSTEM BORING BARS



M-SİSTEM DELİK TORNA KATERLERİ

M-SYSTEM BORING BARS

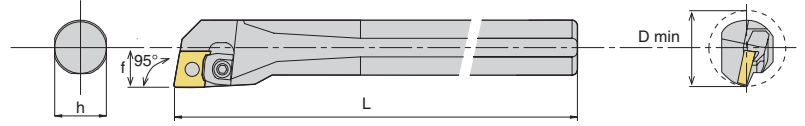

Takım Kodu Ordering Code	Stok Stock		Kater Ölçüleri (mm) Dimension (mm)					Kesici Uç Insert	Yedek Parçaları Spare Parts					
	R	L	d	h	L	f	D min		Baskı Parçası Wedge Clamp	Baskı Vidası Screw	Altlık Shim	Pim Pin	Pul Stamp	Anahtar Allen Key
S20R MCLNR/L 12	●	●	20	18	200	13	≈25	CNM. 12 04..	AMK-03	AKV-04-M5x20	-	APM-04	-	AAL-03-3
S25S MCLNR/L 12	●	●	25	23	250	17	≈32				AACN-3-0001			
S32T MCLNR/L 12	○	○	32	30	300	22	≈40							

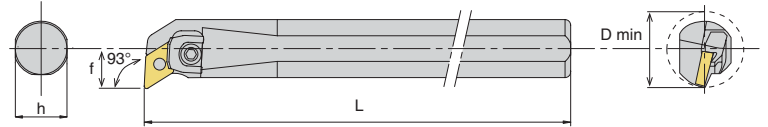

Takım Kodu Ordering Code	Stok Stock		Kater Ölçüleri (mm) Dimension (mm)					Kesici Uç Insert	Yedek Parçaları Spare Parts					
	R	L	d	h	L	f	D min		Baskı Parçası Wedge Clamp	Baskı Vidası Screw	Altlık Shim	Pim Pin	Pul Stamp	Anahtar Allen Key
S20R MDUNR/L 11	●	●	20	18	200	13	≈25	DNM. 11 04..	AMK-03	AKV-04-M5x20	-	APM-03	-	AAL-03-3
S25S MDUNR/L 11	○	○	25	23	250	17	≈32							
S32T MDUNR/L 11	○	○	32	30	300	22	≈40							
S25S MDUNR/L 15	●	●	25	23	250	17	≈32	DNM. 15 06..	AMK-04	AKV-02-M6x20	AADN-3-0001	APM-04	ABPL-01	AAL-03-3
S32T MDUNR/L 15	○	○	32	30	300	22	≈40							
S40U MDUNR/L 15	○	○	40	37	350	27	≈50							
S50V MDUNR/L 15	●	●	50	47	400	35	≈63							

R: Sağ/Right L: Sol/Left ● Stokta/In Stock ○ Stokta Yok/Non Stock Item

Sipariş Örneği/Ordering Example : 1 ad./pcs. S20R MDUNR 11

M-SİSTEM DELİK TORNA KATERLERİ

M-SYSTEM BORING BARS

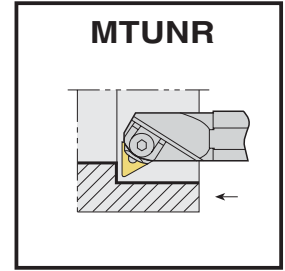
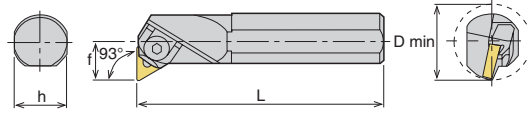

Takım Kodu Ordering Code	Stok Stock		Kater Ölçüleri (mm) Dimension (mm)				Kesici Uç Insert	Yedek Parçaları Spare Parts						
	R	L	d	h	L	f		D min	Baskı Parçası Wedge Clamp	Baskı Vidası Screw	Altlık Shim	Pim Pin	Pul Stamp	Anahtar Allen Key
S20R MTUNR/L 16	●	●	20	18	200	13	≥25	TNM. 16 04..	AMK-02	AKV-04-M5x20	-	APM-03	-	
S25S MTUNR/L 16	●	●	25	23	250	17	≥32				AATN-2-0002	APM-01		
S32T MTUNR/L 16	●	●	32	30	300	22	≥40							
S40U MTUNR/L 16	●	●	40	37	350	27	≥50		AMK-04	AKV-02-M6x20			ABPL-01	AAL-03-3
S32T MTUNR/L 22	●	●	32	30	300	22	≥40	TNM. 22 04..			AATN-3-0015	APM-02		
S40U MTUNR/L 22	●	●	40	37	350	27	≥50							
S50V MTUNR/L 22	●	●	50	47	400	35	≥63							

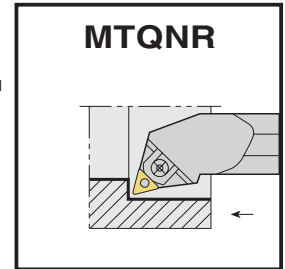
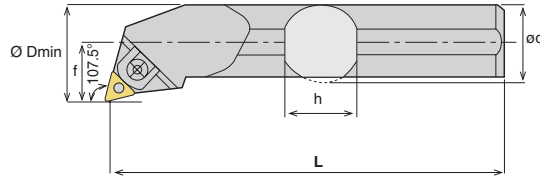

Takım Kodu Ordering Code	Stok Stock		Kater Ölçüleri (mm) Dimension (mm)				Kesici Uç Insert	Yedek Parçaları Spare Parts						
	R	L	d	h	L	f		D min	Baskı Parçası Wedge Clamp	Baskı Vidası Screw	Altlık Shim	Pim Pin	Pul Stamp	Anahtar Allen Key
S20R MTQNR/L 16	●	●	20	18	200	13	≥25	TNM. 16 04..	AMK-02	AKV-04-M5x20	-	APM-03	-	
S25S MTQNR/L 16	●	●	25	23	250	17	≥32				AATN-2-0002	APM-01		
S32T MTQNR/L 16	●	●	32	30	300	22	≥40							
S40U MTQNR/L 16	●	●	40	37	350	27	≥50		AMK-04	AKV-02-M6x20			ABPL-01	AAL-03-3
S32T MTQNR/L 22	●	●	32	30	300	22	≥40	TNM. 22 04..			AATN-3-0015	APM-02		
S40U MTQNR/L 22	●	●	40	37	350	27	≥50							
S50V MTQNR/L 22	●	●	50	47	400	35	≥63							

R: Sağ/Right L: Sol/Left ● Stokta/In Stock ○ Stokta Yok/Non Stock Item

Sipariş Örneği/Ordering Example : 1 ad./pcs. S20R MTQNR 16

M-SİSTEM DELİK TORNA KATERLERİ

M-SYSTEM BORING BARS

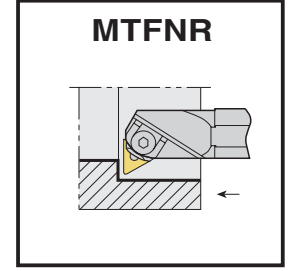
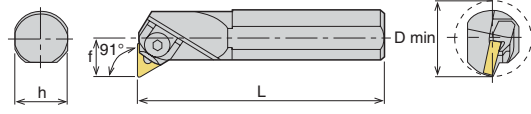

Takım Kodu Ordering Code	Stok Stock	Kater Ölçüleri (mm) Dimension (mm)						Kesici Uç Insert	Yedek Parçaları Spare Parts						
		R	L	d	h	L	f		D min	Baskı Parçası Wedge Clamp	Baskı Vidası Screw	Altlık Shim	Pim Pin	Pul Stamp	Anahtar Allen Key
S20R MTFNR/L 16	● ○	20	18	200	13	±25	TNM. 16 04..			AKV-04-M5x20	-	APM-03	-		
S25S MTFNR/L 16	● ●	25	23	250	17	±32					AATN-2-0002	APM-01			
S32T MTFNR/L 16	● ●	32	30	300	22	±40						AATN-3-0015	APM-02		
S40U MTFNR/L 16	○ ○	40	37	350	27	±50	TNM. 22 04..		AKV-02-M6x20	-	ABPL-01		AAL-03-3		
S32T MTFNR/L 22	○ ○	32	30	300	22	±40				AATN-3-0015	APM-02				
S40U MTFNR/L 22	○ ○	40	37	350	27	±50									
S50V MTFNR/L 22	○ ○	50	47	400	35	±63									

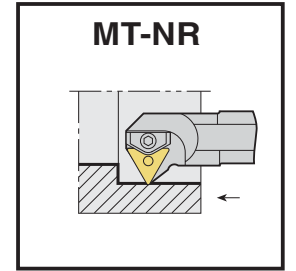
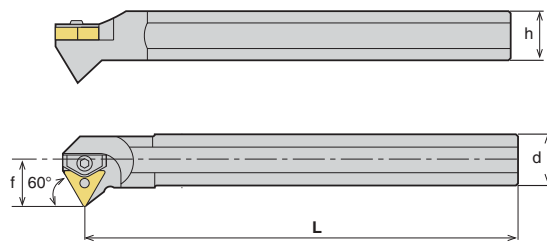

Takım Kodu Ordering Code	Stok Stock	Kater Ölçüleri (mm) Dimension (mm)						Kesici Uç Insert	Yedek Parçaları Spare Parts						
		R	L	d	h	L	f		D min	Baskı Parçası Wedge Clamp	Baskı Vidası Screw	Altlık Shim	Pim Pin	Pul Stamp	Anahtar Allen Key
S20R MT-NR/L 16	● ●	20	18	200	13	±25	TNM. 16 04..			AKV-04-M5x20	-	APM-03	-		
S25S MT-NR/L 16	● ●	25	23	250	17	±32					AATN-2-0002	APM-01	ABPL-01		AAL-03-3
S32T MT-NR/L 16	● ●	32	30	300	22	±40						AATN-3-0015	APM-02		
S40U MT-NR/L 16	● ●	40	37	350	27	±50	TNM. 22 04..		AKV-02-M6x20	-	ABPL-01		AAL-03-3		
S40U MT-NR/L 22	● ●	40	37	350	27	±50				AATN-3-0015	APM-02				

R: Sağ/Right L: Sol/Left ● Stokta/In Stock ○ Stokta Yok/Non Stock Item

Sipariş Örneği/Ordering Example : 1 ad./pcs. S20R MT-NR 16

M-SİSTEM DELİK TORNA KATERLERİ

M-SYSTEM BORING BARS

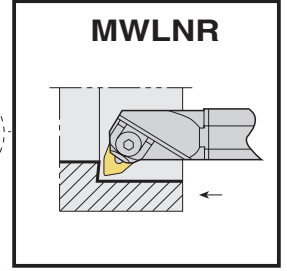
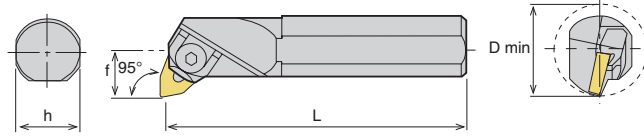

Takım Kodu Ordering Code	Stok Stock		Kater Ölçüleri (mm) Dimension (mm)					Kesici Uç Insert	Yedek Parçaları Spare Parts					
	R	L	d	h	L	f	D min		Baskı Parçası Wedge Clamp	Baskı Vidası Screw	Altılık Shim	Pim Pin	Pul Stamp	Anahtar Allen Key
S16P MWLNR/L 06	●	●	16	15	170	11	321	WNM. 06 04..	AMK-01	AKV-17-M5x18	-	APM-03	-	AAL-03-3
S20R MWLNR/L 06	●	●	20	18	200	13	325			AKV-04-M5x20				
S25S MWLNR/L 06	●	●	25	23	250	17	332	WNM. 08 04..	AMK-05	AKV-03-M6x20	AAWN-3-0001	APM-02	ABPL-01	
S25S MWLNR/L 08	●	●	25	23	250	17	332							
S32T MWLNR/L 08	●	●	32	30	300	22	340							
S40U MWLNR/L 08	●	●	40	37	350	27	350							

R: Sağ/Right L: Sol/Left ● Stokta/In Stock ○ Stokta Yok/Non Stock Item

Sipariş Örneği/Ordering Example : 1 ad./pcs. S16P MWLNR 06

Konuşulan Kalite

The Spoken Quality



 **AKKO**[®]



S SISTEM

S SISTEM DELİK TORNA KATERLERİ
S SYSTEM BORING BARS



S-SİSTEM DELİK TORNA KATERLERİ

S-SYSTEM BORING BARS

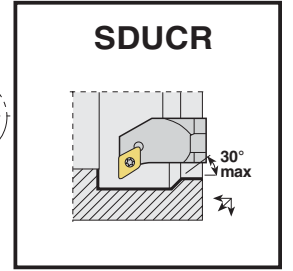
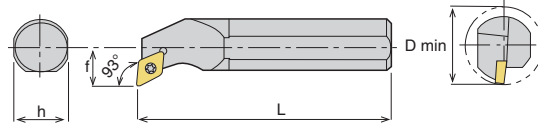

Takım Kodu Ordering Code	Stok Stock	Kater Ölçüleri (mm) Dimension (mm)						Kesici Uç Insert	Yedek Parçaları Spare Parts			
		R	L	d	h	L	f		D min	Sıkma Vidası Clamp Screw	Altık Shim	Altık Vidası Shim Screw
S10K SDUCR/L 07	●	●	10	09	125	07	φ13	DCM. 07 02..	1008-M2.5X7	-	-	80-T08
S12K SDUCR/L 07	●	●	12	11	125	09	φ16					
S16P SDUCR/L 07	●	●	16	15	170	11	φ21					
S20R SDUCR/L 07	●	●	20	18	200	13	φ25					
A10H SDUCR/L 07	●	●	10	09	100	07	φ13					
A12H SDUCR/L 07	●	●	12	11	100	09	φ16					
A16M SDUCR/L 07	●	●	16	15	150	11	φ21					
A20P SDUCR/L 07	●	●	20	18	170	13	φ25					
S16P SDUCR/L 11	●	●	16	15	170	11	φ21	DCM. 11 T3..	1015-M3.5X9	-	-	80-T15
S20R SDUCR/L 11	●	●	20	18	200	13	φ25					
S25S SDUCR/L 11	●	●	25	23	250	17	φ32					
S32T SDUCR/L 11	●	●	32	30	300	22	φ40					
S40U SDUCR/L 11	●	●	40	37	350	27	φ50					
A16M SDUCR/L 11	●	●	16	15	150	11	φ21					
A20P SDUCR/L 11	●	●	20	18	170	13	φ25					
A25R SDUCR/L 11	●	●	25	23	200	17	φ32	1015-M3.5X14	AADN-2-0001	AAV-06-M3.5x11		
A32S SDUCR/L 11	●	●	32	30	250	22	φ40					

R: Sağ/Right L: Sol/Left ● Stokta/In Stock ○ Stokta Yok/Non Stock Item

Sipariş Örneği/Ordering Example : 1 ad./pcs. S10K SDUCR 07

S-SİSTEM DELİK TORNA KATERLERİ

S-SYSTEM BORING BARS

107.5 °

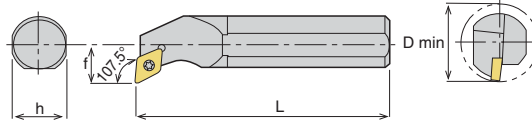

SDQCR

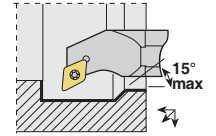

Takım Kodu Ordering Code	Stok Stock		Kater Ölçüleri (mm) Dimension (mm)					Kesici Uç Insert	Yedek Parçaları Spare Parts			
	R	L	d	h	L	f	D min		Sıkma Vidası Clamp Screw	AAltık Shim	AAltık Vidası Shim Screw	Tork Anahtar Torx Key
S10K SDQCR/L 07	●	●	10	09	125	07	φ13	DCM. 07 02..	1008-M2.5x7	-	-	80-T08
S12K SDQCR/L 07	●	●	12	11	125	09	φ16					
S16P SDQCR/L 07	●	●	16	15	170	11	φ21					
S20R SDQCR/L 07	●	●	20	18	200	13	φ25					
A10H SDQCR/L 07	●	●	10	09	100	07	φ13					
A12H SDQCR/L 07	●	●	12	11	100	09	φ16					
A16M SDQCR/L 07	●	●	16	15	150	11	φ21					
A20P SDQCR/L 07	●	●	20	18	170	13	φ25					
S16P SDQCR/L 11	●	●	16	15	170	11	φ21	DCM. 11 T3..	1015-M3.5x9	-	-	80-T15
S20R SDQCR/L 11	●	●	20	18	200	13	φ25					
S25S SDQCR/L 11	●	●	25	23	250	17	φ32					
S32T SDQCR/L 11	●	●	32	30	300	22	φ40					
S40U SDQCR/L 11	○	○	40	37	350	27	φ50					
A16M SDQCR/L 11	●	●	16	15	150	11	φ21					
A20P SDQCR/L 11	●	●	20	18	170	13	φ25					
A25R SDQCR/L 11	●	●	25	23	200	17	φ32	1015-M3.5x9	-	-		
A32S SDQCR/L 11	●	●	32	30	250	22	φ40	1015-M3.5x14	AADN-2-0001	AAV-06-M3.5x11		

R: Sağ/Right L: Sol/Left ● Stokta/In Stock ○ Stokta Yok/Non Stock Item

Sipariş Örneği/Ordering Example : 1 ad./pcs. S10K SDQCR 07



S-SİSTEM DELİK TORNA KATERLERİ

S-SYSTEM BORING BARS

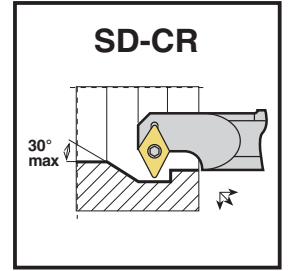
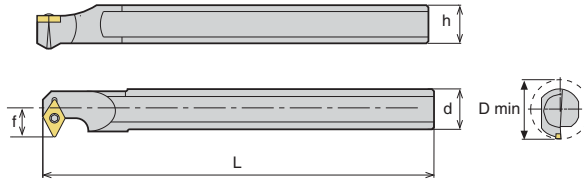

Takım Kodu Ordering Code	Stok Stock		Kater Ölçüleri (mm) Dimension (mm)					Kesici Uç Insert	Yedek Parçaları Spare Parts			
	R	L	d	h	L	f	D min		Sıkma Vidası Clamp Screw	Altık Shim	Altık Vidası Shim Screw	Tork Anahtar Torx Key
S12K SD-CR/L 07	●	●	12	11	125	09	ø17	DCM. 07 02..	1008-M2.5x7	-	-	80-T08
S16P SD-CR/L 07	○	○	16	15	170	11	ø21					
S20R SD-CR/L 07	○	○	20	18	200	13	ø25	DCM. 11 T3..	1015-M3.5x9	-	-	80-T15
S16P SD-CR/L 11	●	●	16	15	170	11	ø21					
S20R SD-CR/L 11	●	●	20	18	200	13	ø25					
S25S SD-CR/L 11	●	●	25	23	250	17	ø32					
S32T SD-CR/L 11	●	●	32	30	300	22	ø40	1015-M3.5X14	AADN-2-0001	AAV-06-M3.5x11	80-T15	
S40U SD-CR/L 11	●	●	40	37	350	27	ø50					

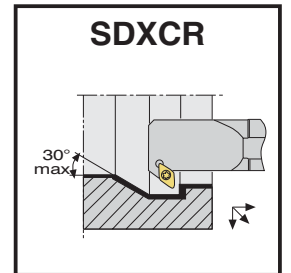
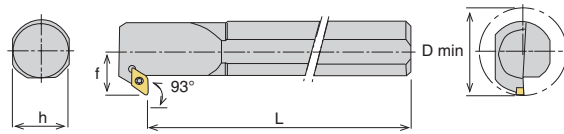

Takım Kodu Ordering Code	Stok Stock		Kater Ölçüleri (mm) Dimension (mm)					Kesici Uç Insert	Yedek Parçaları Spare Parts			
	R	L	d	h	L	f	D min		Sıkma Vidası Clamp Screw	Altık Shim	Altık Vidası Shim Screw	Tork Anahtar Torx Key
S12K SDXCR/L 07	●	●	12	11	125	09	ø17	DCM. 07 02..	1008-M2.5x7	-	-	80-T08
S16P SDXCR/L 07	●	●	16	15	170	11	ø21					
S20R SDXCR/L 07	○	○	20	18	200	13	ø25	DCM. 11 T3..	1015-M3.5x9	-	-	80-T15
S16P SDXCR/L 11	○	○	16	15	170	11	ø21					
S20R SDXCR/L 11	●	●	20	18	200	13	ø25					
S25S SDXCR/L 11	●	●	25	23	250	17	ø32					
S32T SDXCR/L 11	●	●	32	30	300	22	ø40	1015-M3.5X14	AADN-2-0001	AAV-06-M3.5x11	80-T15	
S40U SDXCR/L 11	●	●	40	37	350	27	ø50					

R: Sağ/Right L: Sol/Left ● Stokta/In Stock ○ Stokta Yok/Non Stock Item

Sipariş Örneği/Ordering Example : 1 ad./pcs. S12K SDXCR 07

S-SİSTEM DELİK TORNA KATERLERİ

S-SYSTEM BORING BARS

117.5 °

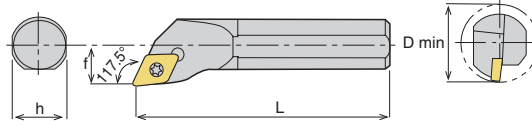

SDPCR

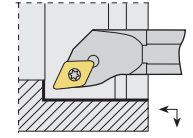

Takım Kodu Ordering Code	Stok Stock		Kater Ölçüleri (mm) Dimension (mm)				Kesici Uç Insert	Yedek Parçaları Spare Parts				
	R	L	d	h	L	f		D min	Sıkma Vidası Clamp Screw	Altık Shim	Altık Vidası Shim Screw	Tork Anahtar Torx Key
S10K SDPCR/L 07	●	●	10	09	125	07	ø13	DCM. 07 02..	1008-M2.5x7	-	-	80-T08
S12K SDPCR/L 07	●	●	12	11	125	09	ø16					
S16P SDPCR/L 11	●	●	16	15	170	11	ø21	DCM. 11 T3..	1015-M3.5x9	-	-	80-T15
S20R SDPCR/L 11	●	●	20	18	200	13	ø25					
S25S SDPCR/L 11	●	●	25	23	250	17	ø32		1015-M3.5X14	AADN-2-0001	AAV-06-M3.5x11	

95 °

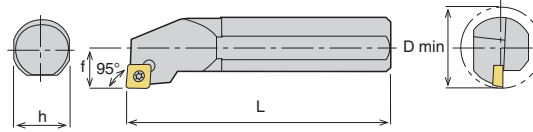

SCLCR

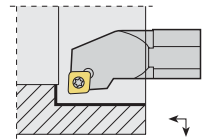

Takım Kodu Ordering Code	Stok Stock		Kater Ölçüleri (mm) Dimension (mm)				Kesici Uç Insert	Yedek Parçaları Spare Parts				
	R	L	d	h	L	f		D min	Sıkma Vidası Clamp Screw	Altık Shim	Altık Vidası Shim Screw	Tork Anahtar Torx Key
S0608H SCLCR/L 06	●	●	06	07	100	4,5	ø8	CCM. 06 02..	1008-M2.5x5	-	-	80-T08
S08H SCLCR/L 06	●	●	08	07	100	06	ø11					
S10K SCLCR/L 06	●	●	10	09	125	07	ø13					
S12K SCLCR/L 06	●	●	12	11	125	09	ø16					
A08H SCLCR/L 06	●	●	08	07	100	06	ø11					
A10H SCLCR/L 06	●	●	10	09	100	07	ø13					
A12H SCLCR/L 06	●	●	12	11	100	09	ø16	1008-M2.5x7				
S12K SCLCR/L 09	●	●	12	11	125	09	ø16	CCM. 09 T3..	1015-M3.5x9	-	-	80-T15
S16P SCLCR/L 09	●	●	16	15	170	11	ø21					
S20R SCLCR/L 09	●	●	20	19	200	13	ø25					
S25S SCLCR/L 09	●	●	25	23	250	17	ø32					
S32T SCLCR/L 09	○	○	32	30	300	22	ø40					
A16M SCLCR/L 09	●	●	16	15	150	11	ø21					
A20P SCLCR/L 09	●	●	20	19	170	13	ø25					
A25R SCLCR/L 09	●	●	25	23	200	17	ø32					
A32S SCLCR/L 09	●	●	32	30	250	22	ø40					
S25S SCLCR/L 12	●	●	25	23	250	17	ø32		1015-M3.5X14			
S32T SCLCR/L 12	●	●	32	30	300	22	ø40	CCM. 12 04..	1020-M4.5x16	AACN-2-0003	AAV-07-M4.5x11	80-T20
S40U SCLCR/L 12	○	○	40	37	350	27	ø50					
A25R SCLCR/L 12	●	●	25	23	200	17	ø32					

R: Sağ/Right L: Sol/Left ● Stokta/In Stock ○ Stokta Yok/Non Stock Item

Sipariş Örneği/Ordering Example : 1 ad./pcs. S0608H SCLCR 06

S-SİSTEM DELİK TORNA KATERLERİ

S-SYSTEM BORING BARS

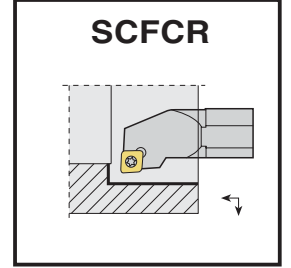
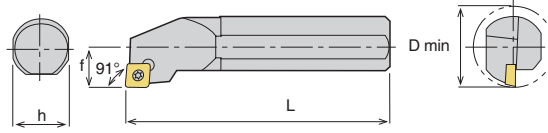

Takım Kodu Ordering Code	Stok Stock		Kater Ölçüleri (mm) Dimension (mm)					Kesici Uç Insert	Yedek Parçaları Spare Parts			
	R	L	d	h	L	f	D min		Sıkma Vidası Clamp Screw	Altık Shim	Altık Vidası Shim Screw	Tork Anahtar Torx Key
S08H SCFCR/L 06	●	●	08	07	100	06	φ11	CCM. 06 02..	1008-M2.5x5			80-T08
S10K SCFCR/L 06	●	●	10	09	125	07	φ13		1008-M2.5x7	-	-	
S12K SCFCR/L 06	●	●	12	11	125	09	φ16					
S16P SCFCR/L 09	●	●	16	15	170	11	φ21	CCM. 09 T3..	1015-M3.5x9	-	-	80-T15
S20R SCFCR/L 09	●	●	20	19	200	13	φ25					
S25S SCFCR/L 09	●	●	25	23	250	17	φ32		1015-M3.5x14	AACN-2-0001	AAV-06-M3.5x11	
S25S SCFCR/L 12	○	○	25	23	250	17	φ32	CCM. 12 04..				80-T20
S32T SCFCR/L 12	○	○	32	30	300	22	φ40		1020-M4.5x16	AACN-2-0003	AAV-07-M4.5x11	
S40U SCFCR/L 12	○	○	40	37	350	27	φ50					

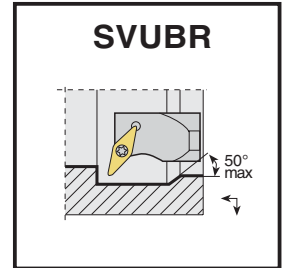
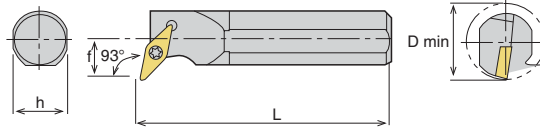

Takım Kodu Ordering Code	Stok Stock		Kater Ölçüleri (mm) Dimension (mm)					Kesici Uç Insert	Yedek Parçaları Spare Parts			
	R	L	d	h	L	f	D min		Sıkma Vidası Clamp Screw	Altık Shim	Altık Vidası Shim Screw	Tork Anahtar Torx Key
S16P SVUBR/L 11	●	●	16	15	170	11	φ21	VBM. 11 03..	1008-M2.5x7	-	-	80-T08
S20R SVUBR/L 11	●	●	20	18	200	13	φ25					
S25S SVUBR/L 16	●	●	25	23	250	17	φ32	VBM. 16 04..				80-T15
S32T SVUBR/L 16	●	●	32	30	300	22	φ40		1015-M3.5x14	AAVN-2-0002	AAV-06-M3.5x11	
S40U SVUBR/L 16	●	●	40	37	350	27	φ50					

R: Sağ/Right L: Sol/Left ● Stokta/In Stock ○ Stokta Yok/Non Stock Item

Sipariş Örneği/Ordering Example : 1 ad./pcs. S16P SVUBR 11

S-SİSTEM DELİK TORNA KATERLERİ

S-SYSTEM BORING BARS

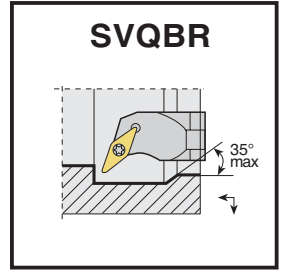
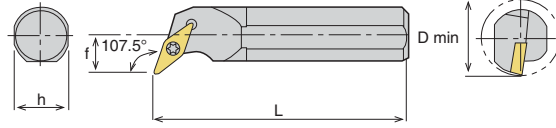

Takım Kodu Ordering Code	Stok Stock		Kater Ölçüleri (mm) Dimension (mm)				Kesici Uç Insert	Yedek Parçaları Spare Parts				
	R	L	d	h	L	f		D min	Sıkma Vidası Clamp Screw	Altık Shim	Altık Vidası Shim Screw	Tork Anahtar Torx Key
S16P SVQBR/L 11	●	●	16	15	170	11	∅21	VBM. 11 03..	1008-M2.5x7	-	-	80-T08
S20R SVQBR/L 11	●	●	20	18	200	13	∅25					
S25S SVQBR/L 16	●	●	25	23	250	17	∅32	VBM. 16 04..	1015-M3.5X14	AAVN-2-0002	AAV-06-M3.5x11	80-T15
S32T SVQBR/L 16	●	●	32	30	300	22	∅40					
S40U SVQBR/L 16	●	●	40	37	350	27	∅50					

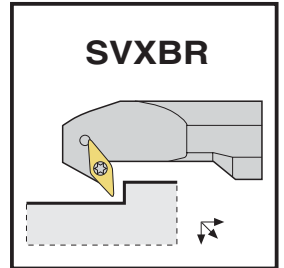
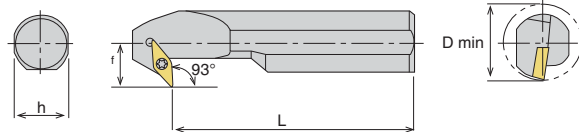

Takım Kodu Ordering Code	Stok Stock		Kater Ölçüleri (mm) Dimension (mm)				Kesici Uç Insert	Yedek Parçaları Spare Parts				
	R	L	d	h	L	f		D min	Sıkma Vidası Clamp Screw	Altık Shim	Altık Vidası Shim Screw	Tork Anahtar Torx Key
S16P SVXBR/L 11	○	○	16	15	170	11	∅21	VBM. 11 03..	1008-M2.5x7	-	-	80-T08
S20R SVXBR/L 11	○	○	20	18	200	13	∅25					
S25S SVXBR/L 16	●	●	25	23	250	17	∅32	VBM. 16 04..	1015-M3.5X14	AAVN-2-0002	AAV-06-M3.5x11	80-T15
S32T SVXBR/L 16	●	●	32	30	300	22	∅40					
S40U SVXBR/L 16	●	●	40	37	350	27	∅50					

R: Sağ/Right L: Sol/Left ● Stokta/In Stock ○ Stokta Yok/Non Stock Item

Sipariş Örneği/Ordering Example : 1 ad./pcs. S16P SVXBR 11

S-SİSTEM DELİK TORNA KATERLERİ

S-SYSTEM BORING BARS

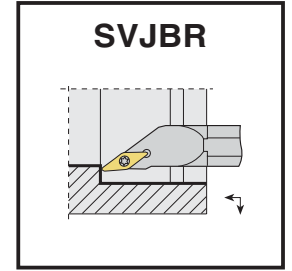
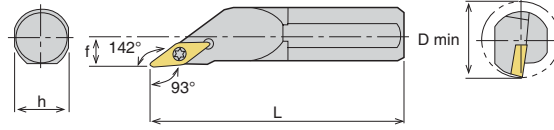

Takım Kodu
Ordering Code

Stok
Stock

Kater Ölçüleri (mm)
Dimension (mm)

Kesici Uç
Insert

Sıkma Vidası
Clamp Screw

Yedek Parçaları
Spare Parts

Aitlik
Shim

Aitlik Vidası
Shim Screw

Tork Anahtar
Torx Key

R L

d

h

L

f

D min

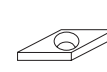

S25S SVJBR/L 16

● ●

25

23

250

17

≈32

S32T SVJBR/L 16

● ●

32

30

300

22

≈40

S40U SVJBR/L 16

● ●

40

37

350

27

≈50

VBM. 16 04..

1015-M3.5X14

AAVN-2-0002

AAV-06-M3.5x11

80-T15

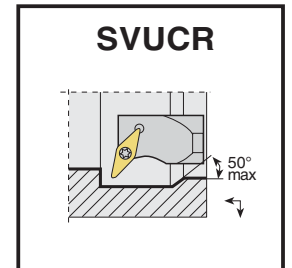
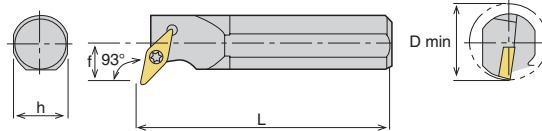

Takım Kodu
Ordering Code

Stok
Stock

Kater Ölçüleri (mm)
Dimension (mm)

Kesici Uç
Insert

Sıkma Vidası
Clamp Screw

Yedek Parçaları
Spare Parts

Aitlik
Shim

Aitlik Vidası
Shim Screw

Tork Anahtar
Torx Key

R L

d

h

L

f

D min

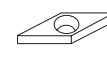

S16P SVUCR/L 11

● ●

16

15

170

11

≈21

S20R SVUCR/L 11

● ●

20

18

200

13

≈25

S25S SVUCR/L 16

● ●

25

23

250

17

≈32

S32T SVUCR/L 16

● ●

32

30

300

22

≈40

S40U SVUCR/L 16

● ●

40

37

350

27

≈50

VCM. 11 03..

1008-M2.5x7

-

-

80-T08

VCM. 16 04..

1015-M3.5X14

AAVN-2-0002

AAV-06-M3.5x11

80-T15

R: Sağ/Right L: Sol/Left ● Stokta/In Stock ○ Stokta Yok/Non Stock Item

Sipariş Örneği/Ordering Example : 1 ad./pcs. S16P SVUCR 11

S-SİSTEM DELİK TORNA KATERLERİ

S-SYSTEM BORING BARS

107.5°

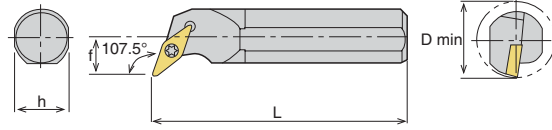

SVQCR

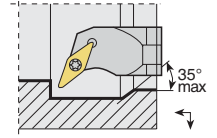

Takım Kodu Ordering Code	Stok Stock		Kater Ölçüleri (mm) Dimension (mm)					Kesici Uç Insert	Yedek Parçaları Spare Parts			
	R	L	d	h	L	f	D min		Sıkma Vidası Clamp Screw	Altık Shim	Altık Vidası Shim Screw	Tork Anahtar Torx Key
S16P SVQCR/L 11	●	●	16	15	170	11	∅21	VCM. 11 03..	1008-M2.5x7	-	-	80-T08
S20R SVQCR/L 11	●	●	20	18	200	13	∅25					
S25S SVQCR/L 16	●	●	25	23	250	17	∅32	VCM. 16 04..	1015-M3.5x14	AAVN-2-0002	AAV-06-M3.5x11	80-T15
S32T SVQCR/L 16	●	●	32	30	300	22	∅40					
S40U SVQCR/L 16	●	●	40	37	350	27	∅50					

93°

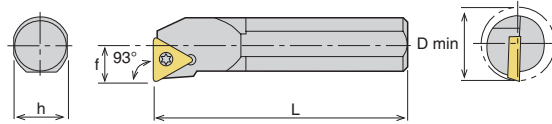

STUCR

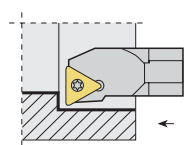

Takım Kodu Ordering Code	Stok Stock		Kater Ölçüleri (mm) Dimension (mm)					Kesici Uç Insert	Yedek Parçaları Spare Parts			
	R	L	d	h	L	f	D min		Sıkma Vidası Clamp Screw	Altık Shim	Altık Vidası Shim Screw	Tork Anahtar Torx Key
S10K STUCR/L 09	●	●	10	9	125	07	∅13	TCM. 0902..	3007-M2.2x5	-	-	80-T07
S12K STUCR/L 09	●	●	12	11	125	09	∅17					
S12K STUCR/L 11	●	●	12	11	125	09	∅17	TCM. 11 02..	1008-M2.5x7	-	-	80-T08
S16P STUCR/L 11	●	●	16	15	170	11	∅21					
S20R STUCR/L 11	●	●	20	18	200	13	∅25	TCM. 16 T3..	1015-M3.5x9	-	-	80-T15
S16P STUCR/L 16	●	●	16	15	170	11	∅21					
S20R STUCR/L 16	●	●	20	18	200	13	∅25					
S25S STUCR/L 16	●	●	25	23	250	17	∅32	1015-M3.5x14	AATN-2-0001	AAV-06-M3.5x11	80-T15	
S32T STUCR/L 16	●	●	32	30	300	22	∅40					
S40U STUCR/L 16	●	●	40	37	350	27	∅50					

R: Sağ/Right L: Sol/Left ● Stokta/In Stock ○ Stokta Yok/Non Stock Item

Sipariş Örneği/Ordering Example : 1 ad./pcs. S10K STUCR 09

S-SİSTEM DELİK TORNA KATERLERİ

S-SYSTEM BORING BARS

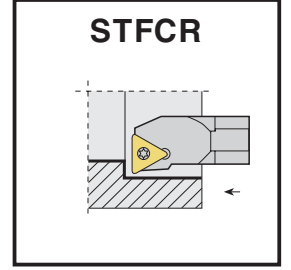
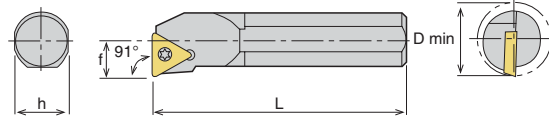

Takım Kodu Ordering Code	Stok Stock	Kater Ölçüleri (mm) Dimension (mm)						Kesici Uç Insert	Yedek Parçaları Spare Parts				
		R	L	d	h	L	f		D min	Sıkma Vidası Clamp Screw	Altılık Shim	Altılık Vidası Shim Screw	Tork Anahtar Torx Key
S0610FSTFCR/L 06	●	●	10	9	125	04	ø08	TCM. 06T1..	3006-M2x4				80-T06
S10K STFCR/L 09	●	●	10	9	125	07	ø13	TCM. 0902..	3007-M2.2x5				80-T07
S12K STFCR/L 09	●	●	12	11	125	09	ø17			-	-		
S12K STFCR/L 11	●	●	12	11	125	09	ø17						
S16P STFCR/L 11	●	●	16	15	170	11	ø21	TCM. 11 02..	1008-M2.5x7				80-T08
S20R STFCR/L 11	●	●	20	18	200	13	ø25						
S16P STFCR/L 16	●	●	16	15	170	11	ø21		1015-M3.5x9	-	-		
S20R STFCR/L 16	●	●	20	18	200	13	ø25						
S25S STFCR/L 16	●	●	25	23	250	17	ø32	TCM. 16 T3..					80-T15
S32T STFCR/L 16	○	○	32	30	300	22	ø40		1015-M3.5X14	AATN-2-0001	AAV-06-M3.5x11		
S40U STFCR/L 16	○	○	40	37	350	27	ø50						

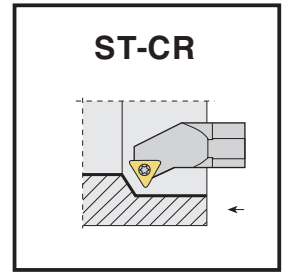
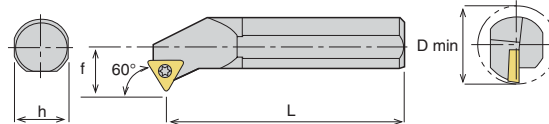

Takım Kodu Ordering Code	Stok Stock	Kater Ölçüleri (mm) Dimension (mm)						Kesici Uç Insert	Yedek Parçaları Spare Parts				
		R	L	d	h	L	f		D min	Sıkma Vidası Clamp Screw	Altılık Shim	Altılık Vidası Shim Screw	Tork Anahtar Torx Key
S12K ST-CR/L 11	○	○	12	11	125	09	ø17						
S16P ST-CR/L 11	○	○	16	15	170	11	ø21	TCM. 11 02..	1008-M2.5x7	-	-		80-T08
S20R ST-CR/L 11	○	○	20	18	200	13	ø25						
S16P ST-CR/L 16	●	●	16	15	170	11	ø21		1015-M3.5x9	-	-		
S20R ST-CR/L 16	●	●	20	18	200	13	ø25						
S25S ST-CR/L 16	●	●	25	23	250	17	ø32	TCM. 16 T3..					80-T15
S32T ST-CR/L 16	●	●	32	30	300	22	ø40		1015-M3.5X14	AATN-2-0001	AAV-06-M3.5x11		
S40U ST-CR/L 16	●	●	40	37	350	27	ø50						

R: Sağ/Right L: Sol/Left ● Stokta/In Stock ○ Stokta Yok/Non Stock Item

Sipariş Örneği/Ordering Example : 1 ad./pcs. S12K ST-CR 11

S-SİSTEM DELİK TORNA KATERLERİ

S-SYSTEM BORING BARS

45°

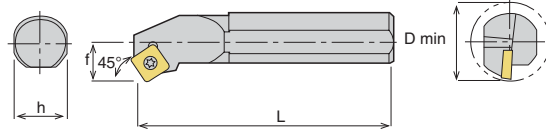

SSSCR

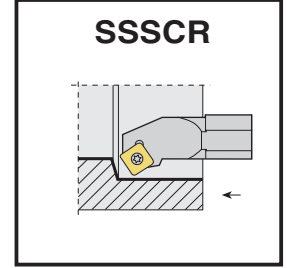

Takım Kodu Ordering Code	Stok Stock		Kater Ölçüleri (mm) Dimension (mm)					Kesici Uç Insert	Yedek Parçaları Spare Parts			
	R	L	d	h	L	f	D min		Sıkma Vidası Clamp Screw	Altılık Shim	Altılık Vidası Shim Screw	Tork Anahtar Torx Key
S16P SSSCR/L 09	●	●	16	15	170	11	ø21	SCM. 09 T3..	1015-M3.5x9	-	-	80-T15
S20R SSSCR/L 09	●	●	20	18	200	13	ø25		1015-M3.5x14	AASN-2-0001	AAV-06-M3.5x11	
S25S SSSCR/L 09	○	○	25	23	250	17	ø32	SCM. 12 04..	1020-M4.5x16	AASN-2-0004	AAV-07-M4.5x11	80-T20
S32T SSSCR/L 12	○	○	32	30	300	22	ø40					
S40U SSSCR/L 12	○	○	40	37	350	27	ø50					

95°

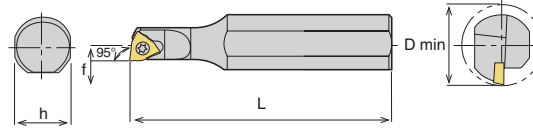

SWLCR

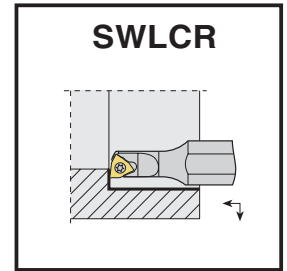

Takım Kodu Ordering Code	Stok Stock		Kater Ölçüleri (mm) Dimension (mm)					Kesici Uç Insert	Yedek Parçaları Spare Parts			
	d	h	L	f	D min	Sıkma Vidası Clamp Screw	Altılık Shim		Altılık Vidası Shim Screw	Tork Anahtar Torx Key		
S0608H SWLCR 03	●	●	08	05	100	04	ø08	WCM. 03 02..	1008-M2.5x5	-	-	80-T08
S0810K SWLCR 03	●	●	10	07	125	07	ø10					

R: Sağ/Right L: Sol/Left ● Stokta/In Stock ○ Stokta Yok/Non Stock Item

Sipariş Örneği/Ordering Example : 1 ad./pcs. S0608H SWLCR 03



P SİSTEM

P SİSTEM DELİK TORNA KATERLERİ

P SYSTEM BORING BARS

P-SİSTEM DELİKTORNA KATERLERİ



P-SİSTEM DELİK TORNA KATERLERİ

P-SYSTEM BORING BARS

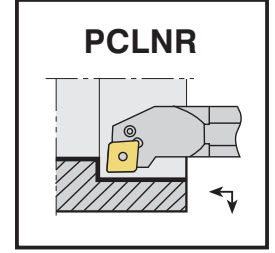
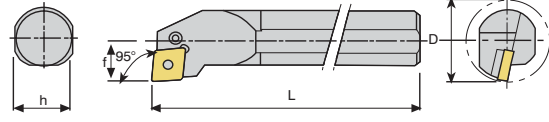

Takım Kodu Ordering Code	Stok Stock		Kater Ölçüleri (mm) Dimension (mm)					Kesici Uç Insert	Yedek Parçaları Spare Parts							
	R	L	d	h	L	f	D min		Levyeye Lever	Levyeye Vidası Lever Screw	Aitlik Shim	Aitlik Yayı Shim Spring	Baskı Parçası Wedge Clamp	Baskı Vidası Screw	Anahtar Allen Key	
S16P PCLNR/L 09	○	○	16	15	170	11	321	CNM. 09 03..								
S20R PCLNR/L 09	○	○	20	18	200	13	325									
S25S PCLNR/L 09	○	○	25	23	250	17	332									
S25S PCLNR/L 12C	●	●	25	23	250	17	332	CNM. 12 04..	APL-02	ALV-03-M8x19	AACN-3-0001	AAAY-02	ACK-05	1515-M4x11	AAL-03-3	
S32T PCLNR/L 12C	●	●	32	30	300	22	340									
S40U PCLNR/L 12C	●	●	40	37	350	27	350									
S50V PCLNR/L 12C	●	●	50	47	400	35	363									
A25R PCLNR/L 12C	●	●	25	23	200	17	332									
A32S PCLNR/L 12C	●	●	32	30	250	22	340									
A40T PCLNR/L 12C	●	●	40	37	300	27	350	CNM. 16 06..	APL-04	ALV-04-M8x22	AACN-3-0002	AAAY-03	ACK-09	AAV-05-M6x15	AAL-05-4	
A50U PCLNR/L 12C	●	●	50	47	350	35	363									
S32T PCLNR/L 16	●	●	32	30	300	22	340									
S40U PCLNR/L 16	●	●	40	37	350	27	350									
S50V PCLNR/L 16	●	●	50	47	400	35	363									
A32S PCLNR/L 16C	●	●	32	30	250	22	340	CNM. 19 06..	APL-05	ALV-05-M10x27	AACN-3-0003	AAAY-04	ACK-09	AAV-05-M6x15	AAL-05-4	
A40T PCLNR/L 16	●	●	40	37	300	27	350									
A50U PCLNR/L 16C	●	●	50	47	350	35	363									
S40U PCLNR/L 19C	●	●	40	37	350	27	350									
S50V PCLNR/L 19C	●	●	50	47	400	35	363	CNM. 19 06..	APL-05	ALV-05-M10x27	AACN-3-0003	AAAY-04	ACK-09	AAV-05-M6x15	AAL-05-4	
A40T PCLNR/L 19C	○	○	40	37	300	27	350									
A50U PCLNR/L 19C	●	●	50	47	350	35	363									

R: Sağ/Right L: Sol/Left ● Stokta/In Stock ○ Stokta Yok/Non Stock Item

Sipariş Örneği/Ordering Example : 1 ad./pcs. S25S PCLNR 12C

P-SİSTEM DELİK TORNA KATERLERİ

P-SYSTEM BORING BARS

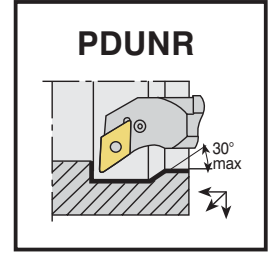
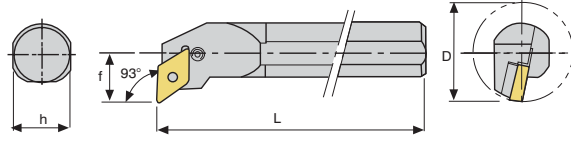

Takım Kodu Ordering Code	Stok Stock		Kater Ölçüleri (mm) Dimension (mm)					Kesici Uç Insert	Yedek Parçaları Spare Parts						
	R	L	d	h	L	f	D min		Levyeye	Levyeye Vidası	Altılık	Altılık Yayı	Baskı Parçası	Baskı Vidası	Anahtar
									Lever	Lever Screw	Shim	Shim Spring	Wedge Clamp	Screw	Allen Key
S20R PDUNR/L 11	●	●	20	18	200	13	325	DNM. 11 04..	APL-01	ALV-01-M6x15 ALV-02-M6x17	AADN-SD317	AAY-01	-	-	AAL-02-2.5
S25S PDUNR/L 11	●	●	25	23	250	17	332								
A20P PDUNR/L 11	●	●	20	18	170	13	325								
A25R PDUNR/L 11	●	●	25	23	200	17	332								
S32T PDUNR/L 15	●	●	32	30	300	22	340	DNM. 15 06..	APL-03	ALV-03-M8x19	AADN-3-0001	AAY-02	-	-	AAL-03-3
S40U PDUNR/L 15	●	●	40	37	350	27	350								
S50V PDUNR/L 15	●	●	50	47	400	35	363								
A32S PDUNR/L 15	●	●	32	30	250	22	340								
A40T PDUNR/L 15	●	●	40	37	300	27	350								
A50U PDUNR/L 15	●	●	50	47	350	35	363								

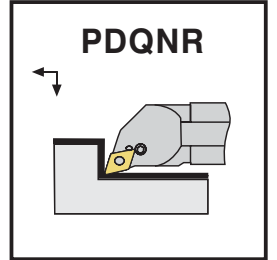
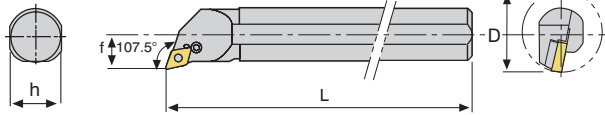

Takım Kodu Ordering Code	Stok Stock		Kater Ölçüleri (mm) Dimension (mm)					Kesici Uç Insert	Yedek Parçaları Spare Parts						
	R	L	d	h	L	f	D min		Levyeye	Levyeye Vidası	Altılık	Altılık Yayı	Baskı Parçası	Baskı Vidası	Anahtar
									Lever	Lever Screw	Shim	Shim Spring	Wedge Clamp	Screw	Allen Key
S20R PDQNR/L 11	○	○	20	18	200	13	325	DNM. 11 04..	APL-01	ALV-01-M6x15 ALV-02-M6x17	AADN-SD317	AAY-01	-	-	AAL-02-2.5
S25S PDQNR/L 11	●	●	25	23	250	17	332								
A20P PDQNR/L 11	●	●	20	18	170	13	325								
A25R PDQNR/L 11	●	●	25	23	200	17	332								
S32T PDQNR/L 15	●	●	32	30	300	22	340	DNM. 15 06..	APL-03	ALV-03-M8x19	AADN-3-0001	AAY-02	-	-	AAL-03-3
S40U PDQNR/L 15	●	●	40	37	350	27	350								
S50V PDQNR/L 15	●	●	50	47	400	35	363								
A32S PDQNR/L 15	●	●	32	30	250	22	340								
A40T PDQNR/L 15	●	●	40	37	300	27	350								
A50U PDQNR/L 15	●	●	50	47	350	35	363								

R: Sağ/Right L: Sol/Left ● Stokta/In Stock ○ Stokta Yok/Non Stock Item

Sipariş Örneği/Ordering Example : 1 ad./pcs. S25S PDQNR 11

P-SİSTEM DELİK TORNA KATERLERİ

P-SYSTEM BORING BARS

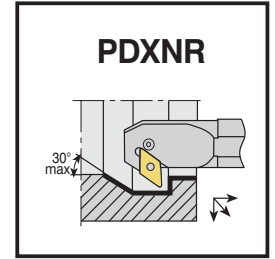
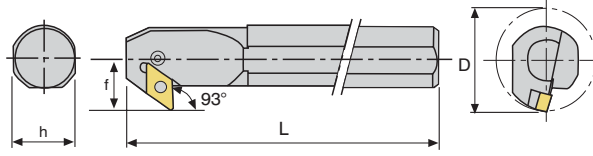

Takım Kodu Ordering Code	Stok Stock		Kater Ölçüleri (mm) Dimension (mm)					Kesici Uç Insert	Yedek Parçaları Spare Parts						
	R	L	d	h	L	f	D min		Levyeye Lever	Levyeye Vidası Lever Screw	Altılık Shim	Altılık Yayı Shim Spring	Baskı Parçası Wedge Clamp	Baskı Vidası Screw	Anahtar Allen Key
S32T PDXNR/L 15	●	●	32	30	300	25	≥45	DNM. 15 06..	APL-03	ALV-03-M8x19	AADN-3-0001	AAY-02	-	-	AAL-03-3
S40U PDXNR/L 15	●	●	40	37	350	27	≥50								
S50V PDXNR/L 15	●	●	50	47	400	35	≥63								

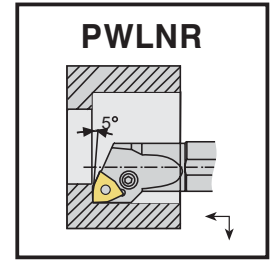
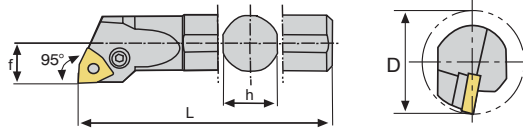

Takım Kodu Ordering Code	Stok Stock		Kater Ölçüleri (mm) Dimension (mm)					Kesici Uç Insert	Yedek Parçaları Spare Parts						
	R	L	d	h	L	f	D min		Levyeye Lever	Levyeye Vidası Lever Screw	Altılık Shim	Altılık Yayı Shim Spring	Baskı Parçası Wedge Clamp	Baskı Vidası Screw	Anahtar Allen Key
S20R PWLNR/L 06	●	●	20	18	200	13	≥25	WNM. 06 04..	APL-01	ALV-02-M6x17	AAWN-SW317	AAY-01	-	-	AAL-02-2.5
S25S PWLNR/L 06	○	○	25	23	250	17	≥32								
A20P PWLNR/L 06	●	●	20	18	170	13	≥25								
A25R PWLNR/L 06	●	●	25	23	200	17	≥32								
A32S PWLNR/L 06	●	●	32	30	250	22	≥40								
S25S PWLNR/L 08C	●	●	25	23	250	17	≥32	WNM. 08 04..	APL-02	ALV-03-M8x19	AAWN-3-0001	AAY-02	ACK-05	1515-M4x11	AAL-03-3
S32T PWLNR/L 08C	●	●	32	30	300	22	≥40								
S40U PWLNR/L 08C	●	●	40	37	350	27	≥50								
S50V PWLNR/L 08C	●	●	50	47	400	35	≥63								
A25R PWLNR/L 08C	●	●	25	23	200	17	≥32								
A32S PWLNR/L 08C	●	●	32	30	250	22	≥40								
A40T PWLNR/L 08C	●	●	40	37	300	27	≥50								
A50U PWLNR/L 08C	●	●	50	47	350	35	≥63								

R: Sağ/Right L: Sol/Left ● Stokta/In Stock ○ Stokta Yok/Non Stock Item

Sipariş Örneği/Ordering Example : 1 ad./pcs. S20R PWLNR 06

P-SİSTEM DELİK TORNA KATERLERİ

P-SYSTEM BORING BARS

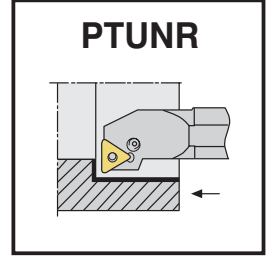
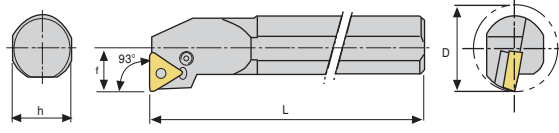

Takım Kodu Ordering Code	Stok Stock		Kater Ölçüleri (mm) Dimension (mm)					Kesici Uç Insert	Yedek Parçaları Spare Parts						
	R	L	d	h	L	f	D min		Leyve Lever	Leyve Vidası Lever Screw	Altlık Shim	Altlık Yayı Shim Spring	Baskı Parçası Wedge Clamp	Baskı Vidası Screw	Anahtar Allen Key
	●	○	●	○	●	○	●		○	●	○	●	○	●	○
S16P PTUNR/L 16	○	○	16	15	170	11	ø21	TNM. 16 04..	APL-01	ALV-01-M6x15	AATN-3-0025	AAY-01	-	-	AAL-02-2.5
S20R PTUNR/L 16	●	●	20	18	200	13	ø25								
S25S PTUNR/L 16C	●	●	25	23	250	17	ø32								
S32T PTUNR/L 16C	●	●	32	30	300	22	ø40								
S40U PTUNR/L 16C	●	●	40	37	350	27	ø50								
S32T PTUNR/L 22C	●	●	32	30	300	22	ø40	TNM. 22 04..	APL-02	ALV-03-M8x19	AATN-3-0015	AAY-02	ACK-05	1515-M4x11	AAL-03-3
S40U PTUNR/L 22C	●	●	40	37	350	27	ø50								
S50V PTUNR/L 22C	●	●	50	47	400	35	ø63								

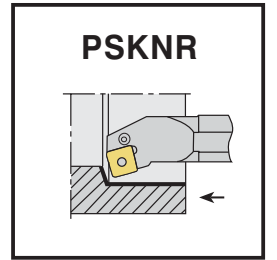
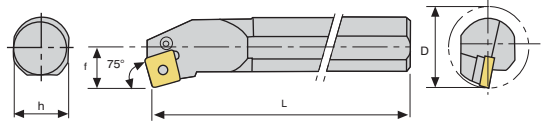

Takım Kodu Ordering Code	Stok Stock		Kater Ölçüleri (mm) Dimension (mm)					Kesici Uç Insert	Yedek Parçaları Spare Parts						
	R	L	d	h	L	f	D min		Leyve Lever	Leyve Vidası Lever Screw	Altlık Shim	Altlık Yayı Shim Spring	Baskı Parçası Wedge Clamp	Baskı Vidası Screw	Anahtar Allen Key
	●	○	●	○	●	○	●		○	●	○	●	○	●	○
S25S PSKNR/L 12C	●	●	25	23	250	17	ø32	SNM. 12 04..	APL-02	ALV-03-M8x19	AASN-3-0004	AAY-02	ACK-05	1515-M4x11	AAL-03-3
S32T PSKNR/L 12C	●	●	32	30	300	22	ø40								
S40U PSKNR/L 12C	●	●	40	37	350	27	ø50								
S50V PSKNR/L 12C	●	●	50	47	400	35	ø63								
S32T PSKNR/L 15	○	○	32	30	300	22	ø40	SNM. 15 06..	APL-04	ALV-04-M8x22	AASN-3-0023	AAY-03	-	-	AAL-05-4
S40U PSKNR/L 15	○	○	40	37	350	27	ø50								
S50V PSKNR/L 15	○	○	50	47	400	35	ø63								

R: Sağ/Right L: Sol/Left ● Stokta/In Stock ○ Stokta Yok/Non Stock Item

Sipariş Örneği/Ordering Example : 1 ad./pcs. S25S PSKNR 12C



KARTUŞLAR

KARTUŞLAR
CARTRIDGE

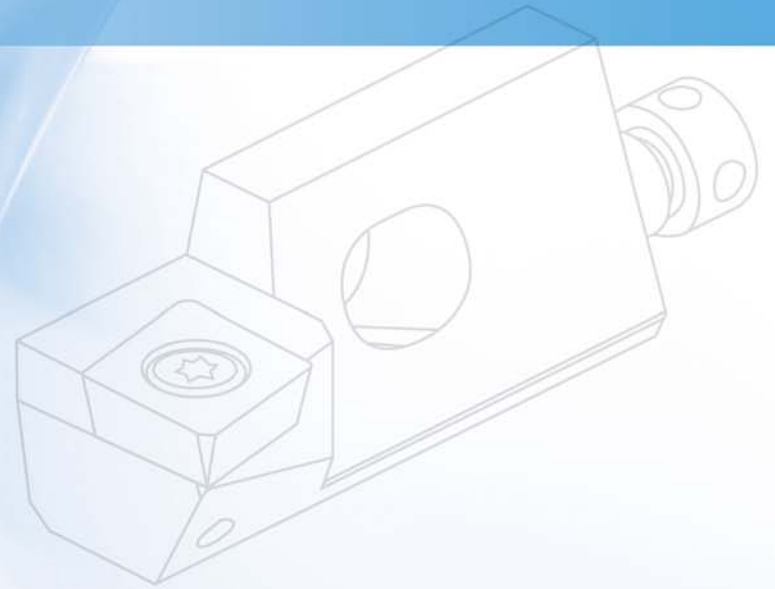

S

1

T

2

F

3

C

4

R

5

12

6

C

7

A

8

16

9

1 Sıkma Tipi / Method of Mounting of Insert

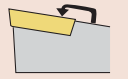

Deliksiz Üstten Sıkma
Top clamping without hole

C

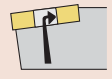

Delikten Laveyle Sıkma
Hole Clamping (Lever Lock)

P

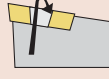

Vıdla ile Sıkma
Screw on

S

2 Uç Tipi / Insert Shape



C



S



T

3 Yanaşma Açısı / ToolHolder Shape

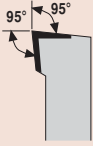

L



S



F

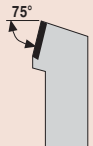

R



K

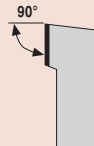

G

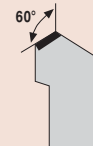

W



T

4 Serbest Uç Açısı / Clearance angle of Insert



C



P



N

5 Kesme Yönü / Cutting Direction

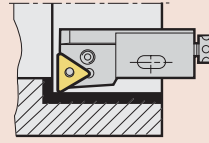

R

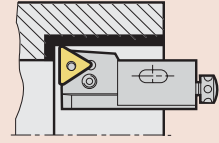

L

6 Kesme Kenar Yüksekliği / Cutting Edge Height

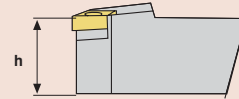

7 Kartuş Kodu / Cartridge Code

C
(Kartuş / Cartridge)

8 Kartuş Tipi / Type of Cartridge

A
(ISO 5611)

9 Kesme Kenar Uzunluğu / Cutting Edge Length



S-TİP HONLAMA KARTUŞLARI

S-TYPE HONING CARTRIDGE

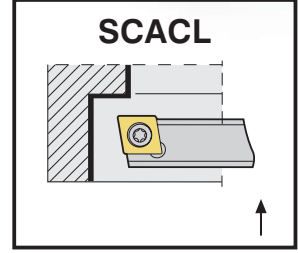
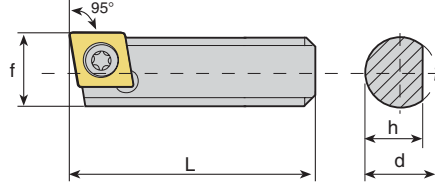

Takım Kodu Ordering Code	Stok Stock		Kater Ölçüleri (mm) Dimension (mm)				Kesici Uç Insert	Yedek Parçaları Spare Parts		
	R	L	d	h	L	f		Sıkma Vidası Clamp Screw	Anahtar Allen Key	
S10X SCACR/L 06	○	●	10	8.5	25	10.5	CCM. 0602..			
S10A SCACR/L 06	○	○	10	8.5	32	10.5				
S10C SCACR/L 06	○	●	10	8.5	50	10.5				
S12B SCACR/L 06	○	●	12	10.5	40	12.5				
S16A SCACR/L 09	○	●	16	14	32	16.5	CCM. 09T3..			
S16B SCACR/L 09	○	●	16	14	40	16.5				
S16C SCACR/L 09	○	●	16	14	50	16.5				
S16D SCACR/L 09	○	●	16	14	60	16.5				
S16E SCACR/L 09	○	●	16	14	70	16.5				
S16G SCACR/L 09	○	●	16	14	90	16.5				
S16H SCACR/L 09	○	○	16	14	100	16.5				

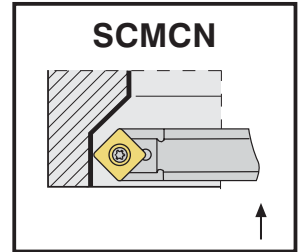
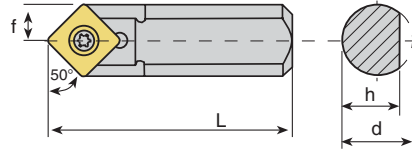

Takım Kodu Ordering Code	Stok Stock		Kater Ölçüleri (mm) Dimension (mm)				Kesici Uç Insert	Yedek Parçaları Spare Parts		
	R	L	d	h	L	f		Sıkma Vidası Clamp Screw	Anahtar Allen Key	
S10X SCMCN 06	●	○	10	8.5	25	5	CCM. 0602..			
S16C SCMCN 09	○	○	16	14	50	8				
S16D SCMCN 09	●	○	16	14	60	8	CCM. 09T3..			
S16D SCMCN 09-R	●	○	16	14	60	8				
S16D SCMCN 09-L	●	○	16	14	60	8				



R: Sağ/Right L: Sol/Left ● Stokta/In Stock ○ Stokta Yok/Non Stock Item

Sipariş Örneği/Ordering Example : 1 ad./pcs. S10X SCMCN 06

S-TİP HONLAMA KARTUŞLARI

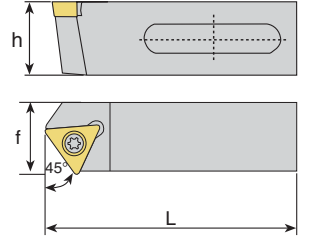
S-TYPE HONING CARTRIDGE





Takım Kodu Ordering Code	Stok Stock		Kater Ölçüleri (mm) Dimension (mm)				Kesici Uç Insert	Yedek Parçaları Spare Parts		
	R	L	d	h	L	f		Sıkma Vidası Clamp Screw	Anahtar Allen Key	
STXCR/L 2020 B16	○	●	20	20	40	20	 TCM. 16T3..	 1015-M3.5x9	 80-T15	
STXCR/L 2020 E16	○	●	20	20	70	20				

S-SİSTEM KARTUŞLAR

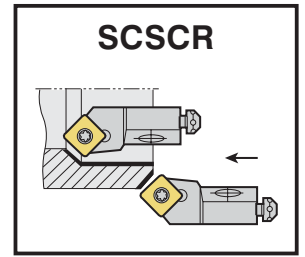
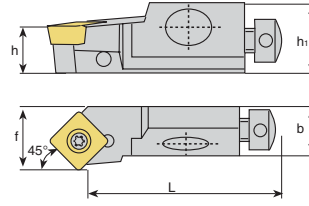
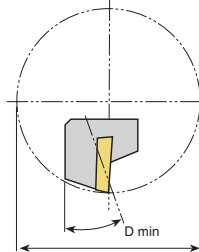
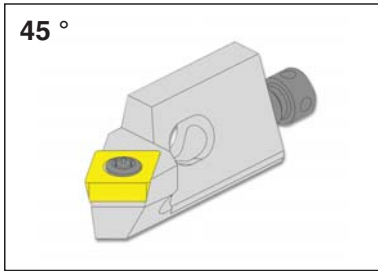
S-SYSTEM CARTRIDGE



Takım Kodu Ordering Code	Stok Stock		Kater Ölçüleri (mm) Dimension (mm)						Kesici Uç Insert	Yedek Parçaları Spare Parts			
	R	L	h	h ₁	b	L	f	D min		Altık Shim	Altık Vidası Shim Screw	Sıkma Vidası Clamp Screw	Anahtar Allen Key
SCSCR/L 06CA 06	○	○	6	8	6	21	8	≈20	 CCM. 0602..	-	-	1008-M2.5x7	80-T08
SCSCR/L 10CA 09	○	○	10	15	11	44	14	≈40	 CCM. 09T3..	AACN-2-0001	AAV-06-M3.5x11	1015-M3.5x14	80-T15
SCSCR/L 12CA 12	○	○	12	18	15	47	20	≈50	 CCM. 1204..	AACN-2-0003	AAV-07-M4.5x11	1020-M4.5x16	80-T20

R: Sağ/Right L: Sol/Left ● Stokta/In Stock ○ Stokta Yok/Non Stock Item

Sipariş Örneği/Ordering Example : 1 ad./pcs. SCSCR 06CA 06

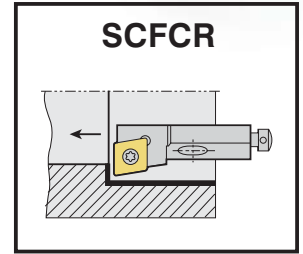
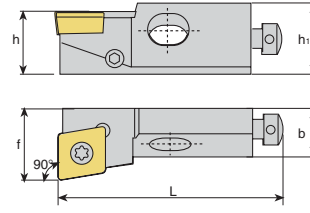
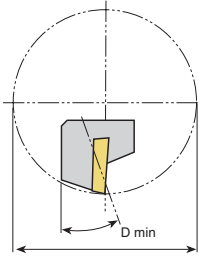

Takım Kodu Ordering Code	Stok Stock		Kater Ölçüleri (mm) Dimension (mm)						Kesici Uç Insert	Yedek Parçaları Spare Parts			
	R	L	h	h ₁	b	L	f	D min		Altık Shim	Altık Vidası Shim Screw	Sıkma Vidası Clamp Screw	Anahtar Allen Key
SCFCR/L 06CA 06	○	○	6	8.5	6	25	8	320					
SCFCR/L 08CA 06	○	○	8	11	8	32	10	320	CCM. 0602..	-	-	1008-M2.5x7	80-T08
SCFCR/L 10CA 09	●	●	10	15	11	50	14	340	CCM. 09T3..	-	-	1015-M3.5x9	80-T15
SCFCR/L 12CA 12	○	○	12	18	15	55	20	350	CCM. 1204..	AACN-2-0003	AAV-07-M4.5x11	1020-M4.5x16	80-T20
SCFCR/L 16CA 12	○	○	16	21	20	63	25	360					

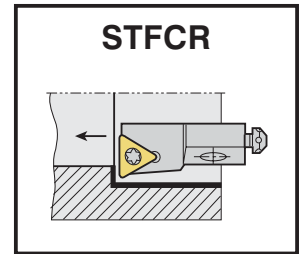
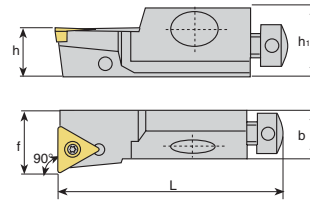
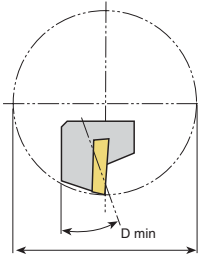

Takım Kodu Ordering Code	Stok Stock		Kater Ölçüleri (mm) Dimension (mm)						Kesici Uç Insert	Yedek Parçaları Spare Parts			
	R	L	h	h ₁	b	L	f	D min		Altık Shim	Altık Vidası Shim Screw	Sıkma Vidası Clamp Screw	Anahtar Allen Key
STFCR/L 10CA 11	●	●	10	15	11	50	14	340					
STFCR/L 12CA 16	○	○	12	20	15	55	20	350	TCM. 16T3..	AATN-2-0001	AAV-06-M3.5x11	1015-M3.5x14	80-T15
STFCR/L 16CA 16	○	○	16	21	20	63	20	360					

R: Sağ/Right L: Sol/Left ● Stokta/In Stock ○ Stokta Yok/Non Stock Item

Sipariş Örneği/Ordering Example : 1 ad./pcs. STFCR 10CA 11

S-SİSTEM KARTUŞLAR

S-SYSTEM CARTRIDGE

45 °

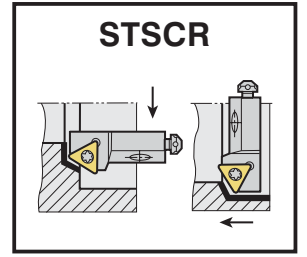
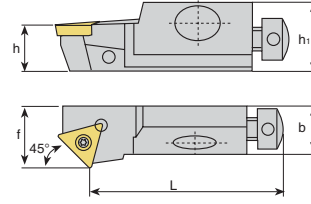
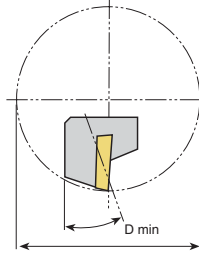

Takım Kodu Ordering Code	Stok Stock		Kater Ölçüleri (mm) Dimension (mm)						Kesici Uç Insert	Yedek Parçaları Spare Parts			
	R	L	h	h ₁	b	L	f	D min		Altık Shim	Altık Vidası Shim Screw	Sıkma Vidası Clamp Screw	Anahtar Allen Key
STSCR/L 08CA 09	○	○	8	11	8	28	10	≈20	TCM. 0902..	-	-	3007-M2.2x5	80-T07
STSCR/L 10CA 11	●	●	10	15	11	44	14	≈40	TCM. 1102..	-	-	1008-M2.5x7	80-T08

60 °

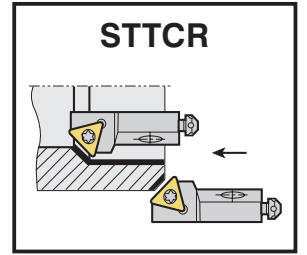
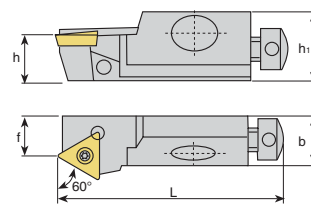
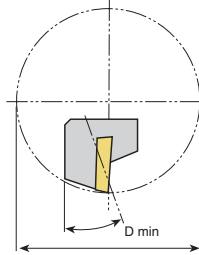
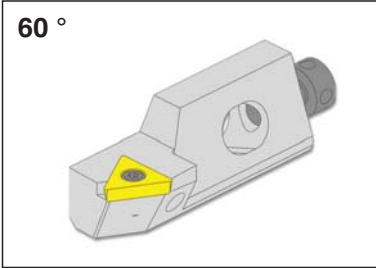

Takım Kodu Ordering Code	Stok Stock		Kater Ölçüleri (mm) Dimension (mm)						Kesici Uç Insert	Yedek Parçaları Spare Parts			
	R	L	h	h ₁	b	L	f	D min		Altık Shim	Altık Vidası Shim Screw	Sıkma Vidası Clamp Screw	Anahtar Allen Key
STTCR/L 08CA 09	○	○	8	9.5	6.5	25.7	10	≈20	TCM. 0902..	-	-	3007-M2.2x5	80-T07
STTCR/L 10CA 11	○	○	10	15	11	42	13.9	≈40	TCM. 1102..	-	-	1008-M2.5x7	80-T08

R: Sağ/Right L: Sol/Left ● Stokta/In Stock ○ Stokta Yok/Non Stock Item

Sipariş Örneği/Ordering Example : 1 ad./pcs. STTCR 08CA 09

45 °

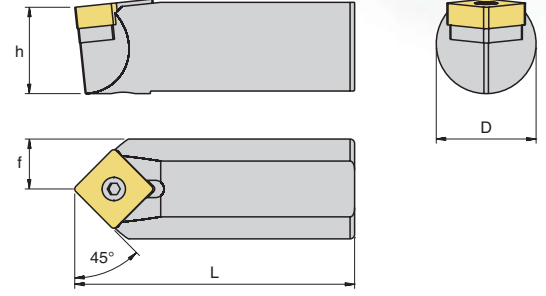

Takım Kodu Ordering Code	Stok Stock	Kater Ölçüleri (mm) Dimension (mm)				Kesici Uç Insert	Yedek Parçaları Spare Parts				
		d	h	L	f		Altlık Shim	Sıkma Vidası Clamp Screw	Baskı Parçası Wedge Clamp	Baskı Vidası Screw	Anahtar Allen Key
S22D PSDNN 12C	●	22	19.5	60	11						
						SNM. 1204..	AASN-20020	AEV-01-M6x16	ACK-05	1515-M4x11	AAL-02-2.5

R: Sağ/Right L: Sol/Left ● Stokta/In Stock ○ Stokta Yok/Non Stock Item

Sipariş Örneği/Ordering Example : 1 ad./pcs. S22D PSDNN 12C





DIŞ AÇMA

DIŞ AÇMA TAKIMLARI
THREADING TOOLHOLDERS



S

1

E

2

R

3

25 25

4-5

M

6

16

7

C

8

1 Sıkma Tipi
Method of Mounting of Insert

S: Vida Sıkmalı
S: Screw Clamping

2 İşlem Tipi
Application

E: Dış / External
I: İç / Internal

3 Kesme Yönü
Cutting Direction

R: Sağ Yan / Right - Hand
L: Sol Yan / Left - Hand

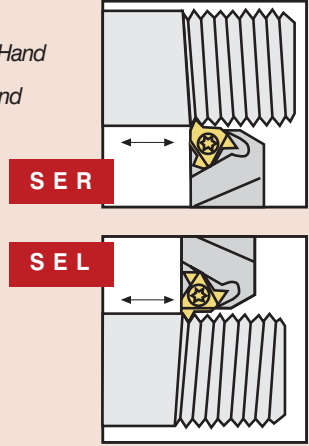

4 Takım Malzemesi / Type of Boring Bar

"A" Yekpare çelik gövde soğutma suyu kanallı / "A" Solid steel with coolant hole
"E" Çelik başlıkla sert metal gövde ve soğutma suyu kanallı /
"E" Carbide bar with fixed steel head and coolant hole
"C" KARBÜR ŞAFT / "C" Carbide shank
"S" Çelik Şaft / "S" Steel shank

4-5 Dış Çap Şaft Ölçüleri
External Shank Size

Şaft : hxb / Shank : hxb
2525 - 25 x 25 mm

5 Şaft Çapı / Shank Diameter

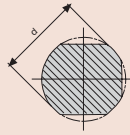

6 Şaft Boyu / Shank Length

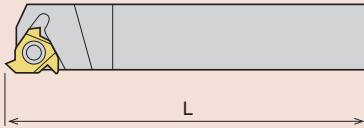

			(mm)
A - 32	H - 100	Q - 180	x-special
B - 40	J - 110	R - 200	
C - 50	K - 125	S - 250	
D - 60	L - 140	T - 300	
E - 70	M - 150	U - 350	
F - 80	N - 160	V - 400	
G - 90	P - 170	W - 450	

7 Elmas Ölçüsü
Insert Size

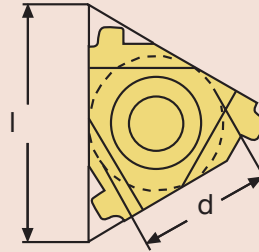

l (mm)	d
06	5/32"
08	3/16"
11	1/4"
16	3/8"
22	1/2"
27	5/8"

8 Baskı Pabucu
Wedge Clamp

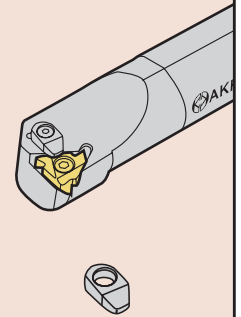

S

1

I

2

R

3

S

4

25

5

R

6

16

7

C

8

DIŞ ÇAP DIŞ AÇMA TAKIMLARI

EXTERNAL THREADING TOOLHOLDERS

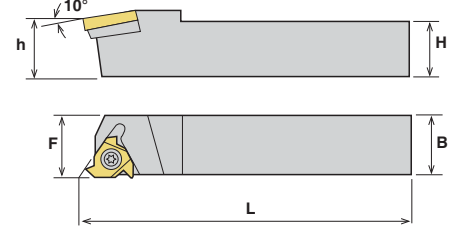
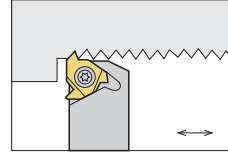

Takım Kodu Ordering Code	Stok Stock		Kater Ölçüleri (mm) Dimension (mm)				Kesici Uç Insert	Yedek Parçaları Spare Parts					
	R	L	h=H	B	L	F		Sıkma Vidası Clamp Screw	Altlık Shim	Altlık Vidası Shim Screw	Baskı Parçası Wedge Clamp	Baskı Vidası Screw	Tork Anahtar Torx Key
SER/L 0808 E 11	●	●	08	08	70	11	11 ER/EL	1008-M2.5x7	-	-	-	-	80-T08
SER/L 1010 E 11	●	●	10	10	70	11							
SER/L 1616 H 11	●	●	16	16	100	16							
SER/L 1616 H 16C	●	●	16	16	100	16	16 ER/EL	1015-M3.5x14	AATN-2-0020	AAV-06-M3.5x11	ACK-05	1515-M4x11	80-T15
SER/L 2020 K 16C	●	●	20	20	125	20							
SER/L 2525 M 16C	●	●	25	25	150	25							
SER/L 3232 P 16C	●	●	32	32	170	32							
SER/L 2525 M 22C	●	●	25	25	150	25	22 ER/EL	1020-M4.5x16	AATN-2-0004	AAV-07-M4.5x11	-	-	80-T20
SER/L 3232 P 22C	●	●	32	32	170	32							
SER/L 4040 S 22C	●	●	40	40	250	40							
SER/L 2525 M 16C-T	●	●	25	25	150	25	16 ER/L (1.5-3 TR)	1015-M3.5x9	-	-	-	-	80-T15
SER/L 2525 M 22C-T	●	●	25	25	150	25	22 ER/L (4-6 TR)	1020-M4.5x16	-	-	-	-	80-T20

R: Sağ/Right L: Sol/Left ● Stokta/In Stock ○ Stokta Yok/Non Stock Item

Sipariş Örneği/Ordering Example : 1 ad./pcs. SER 0808 E11

DELİK İÇİ DİŞ AÇMA TAKIMLARI

INTERNAL THREADING TOOLHOLDERS

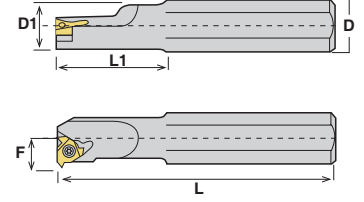
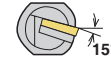
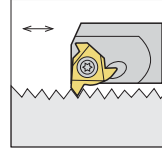

Takım Kodu Ordering Code	Stok Stock	Kater Ölçüleri (mm) Dimension (mm)						Kesici Uç Insert	Yedek Parçaları Spare Parts						
		R	L	D	D1	L	L1		F	D min	Sıkma Vidası Clamp Screw	Altık Shim	Altık Vidası Shim Screw	Baskı Parçası Wedge Clamp	Baskı Vidası Screw
SIR/L S16X07M 08	●●	16	07	150	18	5.3	7.8	08 IR/L	3007-M2.2x5	-	-	-	-	-	80-T07
SIR/L S10H 11	●●	10	10	100	-	7.4	12	11 IR/L	1008-M2.5x7	-	-	-	-	80-T08	
SIR/L S12K 11	●●	12	12	125	-	8.4	16								
SIR/L S16X10M 11	●●	16	10	150	25	7.4	12								
SIR/L S16X13M 11	●●	16	13	150	32	8.9	15	16 IR/L	1015-M3.5x9	-	-	-	-	80-T15	
SIR/L S16X13M 16	○	16	13	150	32	10.2	16								
SIR/L S16M 16	●●	16	16	150	-	11.7	19								
SIR/L S20X16P 16	○	20	16	170	40	11.7	19								
SIR/L S20P 16	●●	20	20	170	-	13.7	24								
SIR/L S25R 16C	●●	25	25	200	-	16.2	29								
SIR/L S32S 16C	●●	32	32	250	-	19.7	36	22 IR/L	1020-M4.5x16	AATN-2-0020	AAV-06-M3.5x11	ACK-05	1515-M4x11	80-T20	
SIR/L S40T 16C	●●	40	40	300	-	23.7	44								
SIR/L S50U 16C	●●	50	50	350	-	28.7	54								
SIR/L S20P 22	●●	20	20	170	-	14	24								
SIR/L S25R 22C	●●	25	25	200	-	18.1	29								
SIR/L S32S 22C	●●	32	32	250	-	21.6	38	16 IR/L (1.5-3 TR)	1015-M3.5x9	-	-	-	-	80-T15	
SIR/L S40T 22C	●●	40	40	300	-	25.6	46								
SIR/L S50U 22C	●●	50	50	350	-	30.6	58	22 IR/L (4-6 TR)	1020-M4.5x16	-	-	-	-	80-T20	
SIR/L S25R 16C-T	●●	25	25	200	-	16.2	29								
SIR/L S32S 16C-T	●●	32	32	250	-	19.7	36								
SIR/L S25R 22C-T	●●	25	25	200	-	18.1	29								
SIR/L S32S 22C-T	●●	32	32	250	-	21.6	38								

R: Sağ/Right L: Sol/Left ● Stokta/In Stock ○ Stokta Yok/Non Stock Item

Sipariş Örneği/Ordering Example : 1 ad./pcs. SIR S16x07M 08



KANAL AÇMA

KANAL AÇMA TAKIMLARI

GROOVING TOOLHOLDERS



AKKO®
ADKT-ZCC2-R-25X25-3-T22
160508

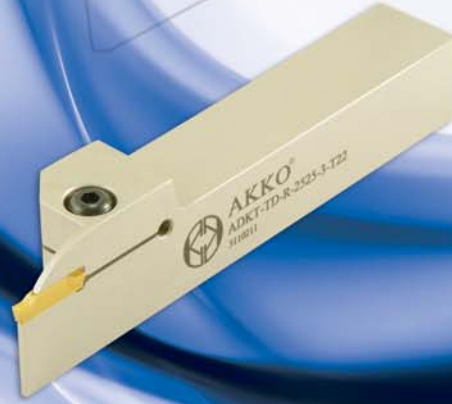



AKKO **A** **AKT** - **K** - **R** - **2525**

1 2 3 4 5

Ø(100-150) - **4** - **T22**

6 7 8

2 Kesiş Stili / Cutter Style

DKT : Dış Çap Kanal Açma Takımı - *External Grooving Toolholders*
IKT : Delik İçi Kanal Açma Takımı - *Internal Grooving Toolholders*
AKT : Dış Çap Alın Kanal Açma Takımı - *Face Grooving Toolholders*

3 Uç Tipi / Insert Type

KRLY / MGM.
HRN / S312, S229, S224, S223
ISCR / DGN, GI, GTN
SNDVK / 123, 151, 154.91
ZCC
KM / A4.
ARN / LOMR.

TGTC / TD.

4 Kesme Yönü / Cutting Direction

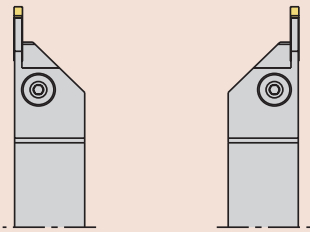

R

L

5 Kesme Kenar Yüksekliği ve Şaft Genişliği
Cutting Edge Height and Shank Width

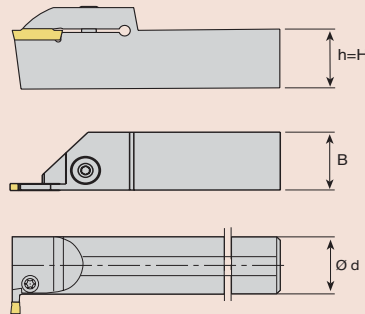

6 Kesme Aralığı / Cutting Diameter

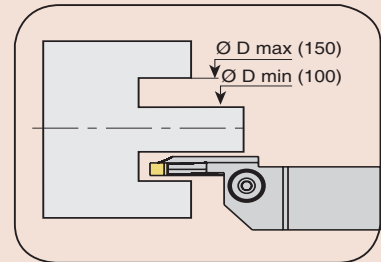

7 Kesme Kenar Genişliği / Cutting Width Edge

ÖR/E.G :
2 = 2.0 mm
3 = 3.0 mm
4 = 4.0 mm
5 = 5.0 mm
6 = 6.0 mm
8 = 8.0 mm



8 Kesme Derinliği / Cutting Depth

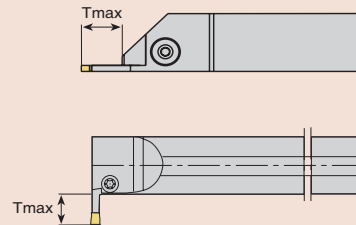

DIŞ ÇAP KANAL AÇMA TAKIMLARI

EXTERNAL GROOVING TOOLHOLDERS

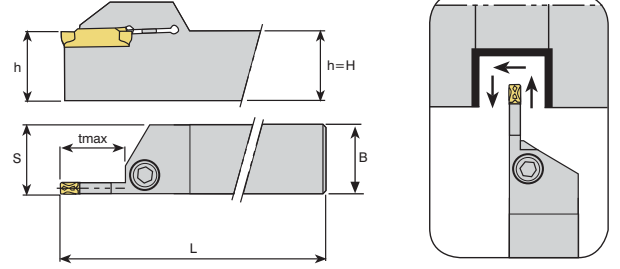

Takım Kodu Ordering Code	Stok Stock		Kater Ölçüleri (mm) Dimension (mm)					Kesici Uç Insert KRLY / MGM.	Yedek Parçaları Spare Parts						
	R	L	h=H	B	L	S	t max		Sıkma Vidası Clamp Screw	Pul Stamp	Anahtar Allen Key				
ADKT-K-R/L- 1212-2-T15	●	●	12	12	100	12.3	15	2	AKV-02-M6x20	ABPL-01	AAL-03-3				
ADKT-K-R/L- 1616-2-T15	●	●	16	16	100	16.3	15								
ADKT-K-R/L- 2020-2-T15	●	●	20	20	125	20.3	15								
ADKT-K-R/L- 2525-2-T15	●	●	25	25	150	25.3	15								
ADKT-K-R/L- 3232-2-T15	○	○	32	32	170	32.3	15								
ADKT-K-R/L- 1212-3-T15	●	●	12	12	100	12.3	15					3	2004-M8x1x20	-	AAL-05-4
ADKT-K-R/L- 1616-3-T15	●	●	16	16	100	16.4	15								
ADKT-K-R/L- 2020-3-T20	●	●	20	20	125	20.4	20								
ADKT-K-R/L- 2525-3-T22	●	●	25	25	150	25.4	22								
ADKT-K-R/L- 3232-3-T22	●	●	32	32	170	32.4	22								
ADKT-K-R/L- 2020-4-T20	●	●	20	20	125	20.4	20	4	2004-M8x1x20	-	AAL-05-4				
ADKT-K-R/L- 2525-4-T22	●	●	25	25	150	25.4	22								
ADKT-K-R/L- 3232-4-T22	●	●	32	32	170	32.4	22								
ADKT-K-R/L- 2020-5-T20	●	●	20	20	125	20.5	20					5	2004-M8x1x20	-	AAL-05-4
ADKT-K-R/L- 2525-5-T25	●	●	25	25	150	25.5	25								
ADKT-K-R/L- 3232-5-T25	●	●	32	32	170	32.5	25								
ADKT-K-R/L- 2525-6-T25	●	○	25	25	150	25.6	25	6	2004-M8x1x20	-	AAL-05-4				
ADKT-K-R/L- 3232-6-T25	●	●	32	32	170	32.6	25								
ADKT-K-R/L- 3232-8-T32	●	●	32	32	170	32.8	32	8	2004-M8x1x20	-	AAL-05-4				

R: Sağ/Right L: Sol/Left ● Stokta/In Stock ○ Stokta Yok/Non Stock Item

Sipariş Örneği/Ordering Example : 1 ad./pcs. ADKT-K-R-1212-2-T15

DIŞ ÇAP KANAL AÇMA TAKIMLARI

EXTERNAL GROOVING TOOLHOLDERS

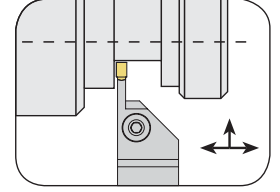
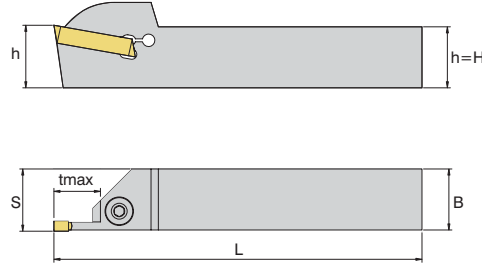

Takım Kodu Ordering Code	Stok Stock		Kater Ölçüleri (mm) Dimension (mm)					Kesici Uç Insert HRN / S229	Yedek Parçaları Spare Parts		
	R	L	h=H	B	L	S	t max		Sıkma Vidası Clamp Screw	Pul Stamp	Anahtar Allen Key
ADKT-H-R/L-2020-3-T20	●	●	20	20	125	20.5	20	3	2004-M8x1x20	-	AAL-05-4
ADKT-H-R/L-2525-3-T22	●	●	25	25	150	25.5	22				
ADKT-H-R/L-2020-4-T20	●	●	20	20	125	20.5	20	4			
ADKT-H-R/L-2525-4-T22	●	●	25	25	150	25.5	22				
ADKT-H-R/L-3232-4-T22	●	●	32	32	170	32.5	22	5			
ADKT-H-R/L-2020-5-T20	●	●	20	20	125	20.5	20				
ADKT-H-R/L-2525-5-T25	●	●	25	25	150	25.5	25	6			
ADKT-H-R/L-2525-6-T25	●	●	25	25	150	25.6	25				

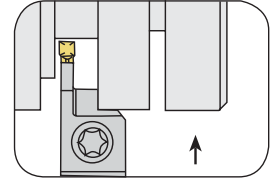
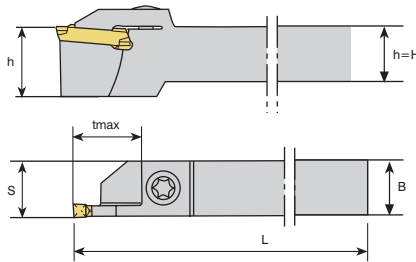

Takım Kodu Ordering Code	Stok Stock		Kater Ölçüleri (mm) Dimension (mm)					Kesici Uç Insert HRN / S224-S223	Yedek Parçaları Spare Parts		
	R	L	h=H	B	L	S	t max		Sıkma Vidası Clamp Screw	Pul Stamp	Anahtar Allen Key
ADKT-HK-R/L-1616 -2-T15	●	●	16	16	100	16.3	15	2	AKV-02-M6x20	ABPL-01	AAL-03-3
ADKT-HK-R/L-2020 -2-T15	●	●	20	20	125	20.3	15				
ADKT-HK-R/L-2525 -2-T15	●	●	25	25	150	25.3	15				
ADKT-HK-R/L-1616 -3-T15	○	○	16	16	100	16.3	15	3	2004-M8x1x20	-	AAL-05-4
ADKT-HK-R/L-2020 -3-T20	●	●	20	20	125	20.4	20				
ADKT-HK-R/L-2525 -3-T22	●	●	25	25	150	25.4	22	4			
ADKT-HK-R/L-2020 -4-T20	●	●	20	20	125	20.4	20				
ADKT-HK-R/L-2525 -4-T22	●	●	25	25	150	25.4	22	2			
ADKT-HS223-R/L-2020-2-T15	●	○	20	20	125	20.4	15				





R: Sağ/Right L: Sol/Left ● Stokta/In Stock ○ Stokta Yok/Non Stock Item

Sipariş Örneği/Ordering Example : 1 ad./pcs. ADKT-HK-R-1616-2-T15

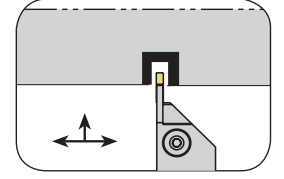
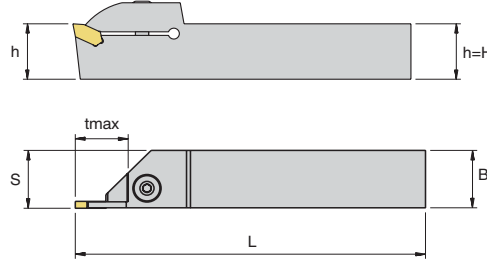





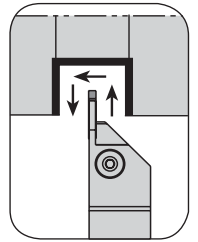
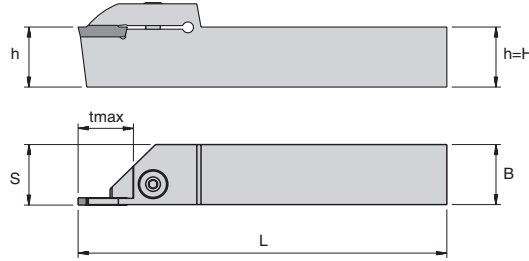

DIŞ ÇAP KANAL AÇMA TAKIMLARI

EXTERNAL GROOVING TOOLHOLDERS



Takım Kodu Ordering Code	Stok Stock		Kater Ölçüleri (mm) Dimension (mm)					Kesici Uç Insert	Yedek Parçaları Spare Parts		
	R	L	h=H	B	L	S	tmax		Sıkma Vidası Clamp Screw	Pul Stamp	Anahtar Allen Key
ADKT-ZCC1-R/L-2020-3-T20	●	○	20	20	125	20.3	20	ZCC1 			
ADKT-ZCC1-R/L-2525-3-T22	●	○	25	25	150	25.3	22				
ADKT-ZCC1-R/L-2020-4-T20	●	○	20	20	125	20.4	20	ZCC1 	2004-M8x1x20	-	AAL-05-4
ADKT-ZCC1-R/L-2525-4-T22	●	○	25	25	150	25.4	22				



Takım Kodu Ordering Code	Stok Stock		Kater Ölçüleri (mm) Dimension (mm)					Kesici Uç Insert	Yedek Parçaları Spare Parts		
	R	L	h=H	B	L	S	tmax		Sıkma Vidası Clamp Screw	Pul Stamp	Anahtar Allen Key
ADKT-ZCC2-R/L-2020-3-T20	●	●	20	20	125	20.3	20	ZCC2 			
ADKT-ZCC2-R/L-2525-3-T22	●	●	25	25	150	25.3	22				
ADKT-ZCC2-R/L-2020-4-T20	●	●	20	20	125	20.5	20	ZCC2 	2004-M8x1x20	-	AAL-05-4
ADKT-ZCC2-R/L-2525-4-T22	●	●	25	25	150	25.5	22				
ADKT-ZCC2-R/L-2020-5-T20	●	●	20	20	125	20.5	20	ZCC2 	2004-M8x1x20	-	AAL-05-4
ADKT-ZCC2-R/L-2525-5-T25	●	●	25	25	150	25.5	25				
ADKT-ZCC2-R/L-2020-6-T20	●	●	20	20	125	20.6	20	ZCC2 	2004-M8x1x20	-	AAL-05-4
ADKT-ZCC2-R/L-2525-6-T25	●	●	25	25	150	25.6	25				
ADKT-ZCC2-R/L-3232-6-T25	●	●	32	32	170	32.6	25	ZCC2 	2004-M8x1x20	-	AAL-05-4





R: Sağ/Right L: Sol/Left ● Stokta/In Stock ○ Stokta Yok/Non Stock Item

Sipariş Örneği/Ordering Example : 1 ad./pcs. ADKT-ZCC2-R-2020-3-T20

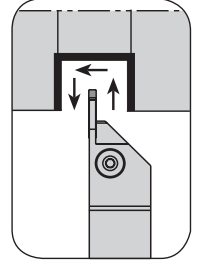
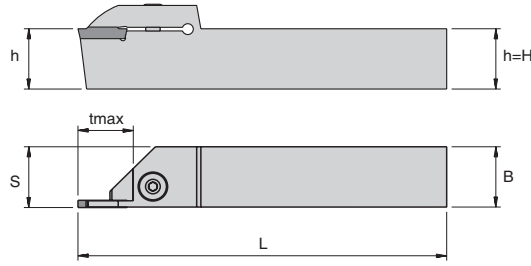



DIŞ ÇAP KANAL AÇMA TAKIMLARI

EXTERNAL GROOVING TOOLHOLDERS

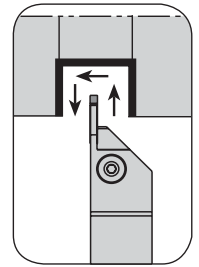
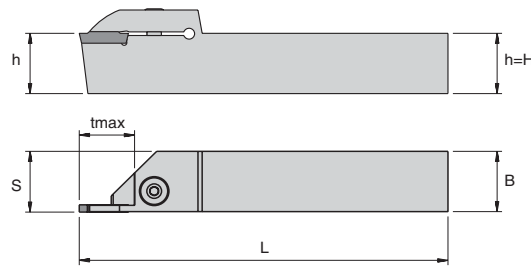

Takım Kodu Ordering Code	Stok Stock		Kater Ölçüleri (mm) Dimension (mm)				Kesici Uç Insert ISCR GIM-GIP-GTN-DGN 	Yedek Parçaları Spare Parts			
	R	L	h=H	B	L	S		Sıkma Vidası Clamp Screw 	Pul Stamp 	Anahtar Allen Key 	
ADKT-I-R/L-1212-2-T15	●	●	12	12	100	12.3	15	2	AKV-02-M6x20	ABPL-01	AAL-03-3
ADKT-I-R/L-1616-2-T15	●	●	16	16	100	16.3	15				
ADKT-I-R/L-2020-2-T15	●	●	20	20	125	20.3	15				
ADKT-I-R/L-2525-2-T15	●	●	25	25	150	25.3	15	3	2004-M8x1x20	-	AAL-05-4
ADKT-I-R/L-1212-3-T15	●	●	12	12	100	12.3	15				
ADKT-I-R/L-1616-3-T15	●	●	16	16	100	16.4	15				
ADKT-I-R/L-2020-3-T20	●	●	20	20	125	20.4	20				
ADKT-I-R/L-2525-3-T22	●	●	25	25	150	25.4	22	4	2004-M8x1x20	-	AAL-05-4
ADKT-I-R/L-2020-4-T20	●	●	20	20	125	20.4	20				
ADKT-I-R/L-2525-4-T22	●	●	25	25	150	25.4	22	5	AKV-02-M6x20	ABPL-01	AAL-03-3
ADKT-IGI-R/L-2020-2-T15	●	●	20	20	125	20.3	15				
ADKT-IGI-R/L-2525-2-T15	●	○	25	25	150	25.4	15				
ADKT-IGI-R/L-1616-3-T15	●	○	16	16	100	16.4	15				
ADKT-IGI-R/L-2525-3-T22	●	●	25	25	150	25.4	22				
ADKT-IGI-R/L-2525-5-T25	●	●	25	25	150	25.6	25	5	2004-M8x1x20	-	AAL-05-4
ADKT-IGTN-R/L-2525-5-T25	●	○	25	25	150	25.6	25				



Takım Kodu Ordering Code	Stok Stock		Kater Ölçüleri (mm) Dimension (mm)				Kesici Uç Insert KM / A4. 	Yedek Parçaları Spare Parts			
	R	L	h=H	B	L	S		Sıkma Vidası Clamp Screw 	Pul Stamp 	Anahtar Allen Key 	
ADKT-KM-R/L-2020-2-T15	●	●	20	20	125	20.3	15	2	AKV-02-M6x20	ABPL-01	AAL-03-3
ADKT-KM-R/L-2525-2-T15	●	●	25	25	150	25.3	15				
ADKT-KM-R/L-2020-3-T20	●	●	20	20	125	20.4	20	3	2004-M8x1x20	-	AAL-05-4
ADKT-KM-R/L-2525-3-T22	●	●	25	25	150	25.4	22				
ADKT-KM-R/L-2525-4-T22	●	○	25	25	150	25.5	22				

R: Sağ/Right L: Sol/Left ● Stokta/In Stock ○ Stokta Yok/Non Stock Item

Sipariş Örneği/Ordering Example : 1 ad./pcs. ADKT-KM-R-2020-2-T15

DIŞ ÇAP KANAL AÇMA TAKIMLARI

EXTERNAL GROOVING TOOLHOLDERS

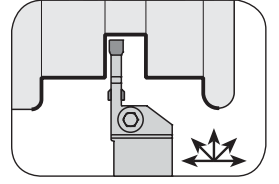
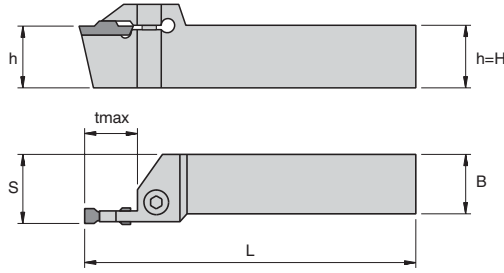

Takım Kodu Ordering Code	Stok Stock		Kater Ölçüleri (mm) Dimension (mm)					Kesici Uç Insert SNDVK / 123	Yedek Parçaları Spare Parts			
	R	L	h=H	B	L	S	t _{max}		Sıkma Vidası Clamp Screw	Pul Stamp	Anahtar Allen Key	
									AKV-02-M6x20	ABPL-01	AAL-03-3	
ADKT-123-R/L-1616-2-T15	●	●	16	16	100	16.3	15	2	AKV-02-M6x20	ABPL-01	AAL-03-3	
ADKT-123-R/L-2020-2-T15	●	●	20	20	125	20.3	15					
ADKT-123-R/L-2525-2-T15	●	●	25	25	150	25.3	15					
ADKT-123-R/L-1616-3-T15	●	●	16	16	100	16.4	15					
ADKT-123-R/L-2020-3-T20	●	●	20	20	125	20.4	20	3	2004-M8x1x20	-	AAL-05-4	
ADKT-123-R/L-2525-3-T22	●	●	25	25	150	25.4	22					
ADKT-123-R/L-2020-4-T20	●	●	20	20	125	20.4	20					
ADKT-123-R/L-2525-4-T22	●	●	25	25	150	25.4	22					
ADKT-123-R/L-2020-5-T20	●	●	20	20	125	20.5	20	4	2004-M8x1x20	-	AAL-05-4	
ADKT-123-R/L-2525-5-T25	●	●	25	25	150	25.5	25					

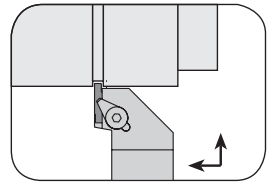
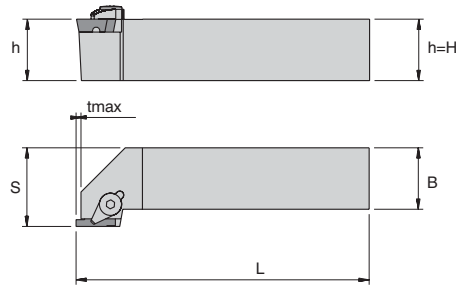

Takım Kodu Ordering Code	Stok Stock		Kater Ölçüleri (mm) Dimension (mm)					Kesici Uç Insert SNDVK / 154.91	Yedek Parçaları Spare Parts				
	R	L	h=H	B	L	S	t _{max}		Baskı Parçası Wedge Clamp	Sıkma Vidası Clamp Screw	Yay Spring	Pul Stamp	Anahtar Allen Key
									ACK-03	AKV-07-M6x20	-	-	AAL-03-3
ADKT-154.91-R/L-2020-3-T4	●	●	20	20	125	20.4	4	3	ACK-03	AKV-07-M6x20	-	-	AAL-03-3
ADKT-154.91-R/L-2525-3-T4	●	●	25	25	150	25.4	4						
ADKT-154.91-R/L-2020-5-T5	●	●	20	20	125	20.5	5	5	ACK-03	AKV-07-M6x20	-	-	AAL-03-3
ADKT-154.91-R/L-2525-5-T5	●	●	25	25	150	25.5	5						

R: Sağ/Right L: Sol/Left ● Stokta/In Stock ○ Stokta Yok/Non Stock Item

Sipariş Örneği/Ordering Example : 1 ad./pcs. ADKT-154.91-R-2020-3-T4

DIŞ ÇAP KANAL AÇMA TAKIMLARI

EXTERNAL GROOVING TOOLHOLDERS

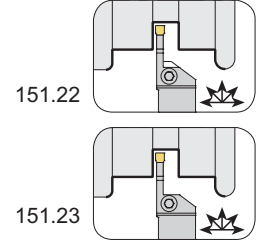
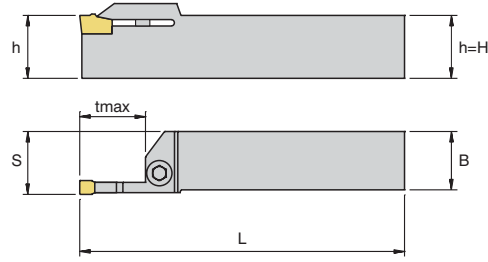

Takım Kodu Ordering Code	Stok Stock		Kater Ölçüleri (mm) Dimension (mm)				Kesici Uç Insert SNDVK / 151.2	Yedek Parçaları Spare Parts			
	R	L	h=H	B	L	S		tmax	Sıkma Vidası Clamp Screw	Pul Stamp	Anahtar Allen Key
ADKT-151.22-R/L-1616-2-T15	●	●	16	16	100	16.3	15	2	AKV-02-M6x20	ABPL-01	AAL-03-3
ADKT-151.22-R/L-2020-2-T15	●	●	20	20	125	20.3	15				
ADKT-151.22-R/L-2525-2-T15	●	●	25	25	150	25.3	15				
ADKT-151.22-R/L-1616-3-T15	●	●	16	16	100	16.4	15				
ADKT-151.22-R/L-2020-3-T20	●	●	20	20	125	20.4	20				
ADKT-151.22-R/L-2525-3-T22	●	●	25	25	150	25.4	22	3	2004-M8x1x20	-	AAL-05-4
ADKT-151.22-R/L-1616-4-T15	○	○	16	16	100	16.4	15				
ADKT-151.22-R/L-2020-4-T20	●	●	20	20	125	20.4	20				
ADKT-151.22-R/L-2525-4-T22	●	●	25	25	150	25.4	22				
ADKT-151.22-R/L-2020-5-T20	●	●	20	20	125	20.5	20				
ADKT-151.22-R/L-2525-5-T25	●	●	25	25	150	25.5	25	5	2004-M8x1x20	-	AAL-05-4
ADKT-151.23-R/L-1616-2-T15	○	○	16	16	100	16.3	15				
ADKT-151.23-R/L-2020-2-T15	●	●	20	20	125	20.3	15				
ADKT-151.23-R/L-2525-2-T15	●	○	25	25	150	25.3	15				
ADKT-151.23-R/L-1616-2.5-T15	○	○	16	16	100	16.3	15				
ADKT-151.23-R/L-2020-2.5-T15	●	○	20	20	125	20.3	15	2.5	2004-M8x1x20	-	AAL-05-4
ADKT-151.23-R/L-2525-2.5-T15	●	●	25	25	150	25.3	15				
ADKT-151.23-R/L-1212-3-T15	●	●	12	12	100	12.4	15				
ADKT-151.23-R/L-1616-3-T15	●	●	16	16	100	16.4	15				
ADKT-151.23-R/L-2020-3-T20	●	●	20	20	125	20.4	20				
ADKT-151.23-R/L-2525-3-T22	●	●	25	25	150	25.4	22	3	2004-M8x1x20	-	AAL-05-4
ADKT-151.23-R/L-1616-4-T15	●	○	16	16	100	16.4	15				
ADKT-151.23-R/L-2020-4-T20	●	●	20	20	125	20.4	20				
ADKT-151.23-R/L-2525-4-T22	●	○	25	25	150	25.4	22				
ADKT-151.23-R/L-2020-5-T20	●	●	20	20	125	20.5	20				
ADKT-151.23-R/L-2525-5-T25	●	●	25	25	150	25.5	25	5	2004-M8x1x20	-	AAL-05-4

R: Sağ/Right L: Sol/Left ● Stokta/In Stock ○ Stokta Yok/Non Stock Item

Sipariş Örneği/Ordering Example : 1 ad./pcs. ADKT-151.22-R-1616-2-T15

DIŞ ÇAP KANAL AÇMA TAKIMLARI

EXTERNAL GROOVING TOOLHOLDERS

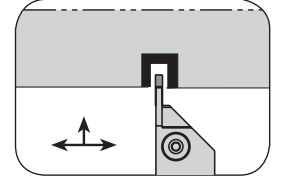
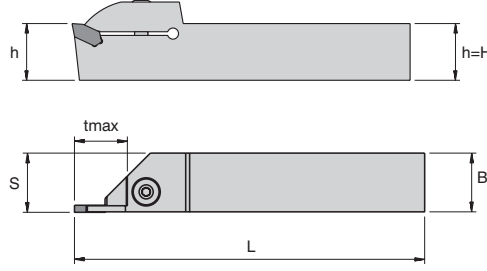

Takım Kodu Ordering Code	Stok Stock		Kater Ölçüleri (mm) Dimension (mm)					Kesici Uç Insert	Yedek Parçaları Spare Parts		
	R	L	h=H	B	L	S	t max		Sıkma Vidası Clamp Screw	Pul Stamp	Anahtar Allen Key
ADKT-ARN-R/L-2020-2-T15	●	●	20	20	125	20.3	15	ARN / LOMR. 			
ADKT-ARN-R/L-2525-2-T15	●	●	25	25	150	25.3	15				
ADKT-ARN-R/L-2020-3-T20	●	●	20	20	125	20.4	20	3	2004-M8x1x20	-	AAL-05-4
ADKT-ARN-R/L-2525-3-T22	●	●	25	25	150	25.4	22				

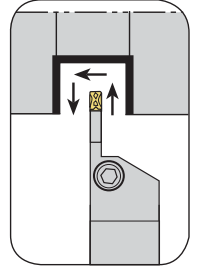
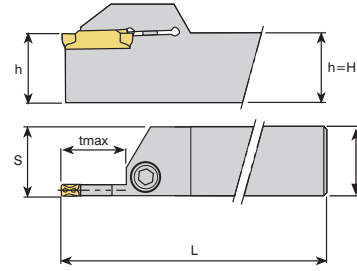





Takım Kodu Ordering Code	Stok Stock		Kater Ölçüleri (mm) Dimension (mm)					Kesici Uç Insert	Yedek Parçaları Spare Parts		
	R	L	h=H	B	L	S	t max		Sıkma Vidası Clamp Screw	Pul Stamp	Anahtar Allen Key
ADKT-TD-R/L-1212-2-T15	●	○	12	12	100	12.3	15	TGTC / TD. 			
ADKT-TD-R/L-1616-2-T15	●	●	16	16	100	16.3	15				
ADKT-TD-R/L-2020-2-T15	●	○	20	20	125	20.3	17	3	2004-M8x1x20	-	AAL-05-4
ADKT-TD-R/L-2525-2-T17	●	○	25	25	150	25.3	17				
ADKT-TD-R/L-1212-3-T15	●	○	12	12	100	12.3	15	3	2004-M8x1x20	-	AAL-05-4
ADKT-TD-R/L-1616-3-T15	●	●	16	16	100	16.4	15				
ADKT-TD-R/L-2020-3-T20	●	●	20	20	125	20.4	22	3	2004-M8x1x20	-	AAL-05-4
ADKT-TD-R/L-2525-3-T22	●	●	25	25	150	25.4	22				

R: Sağ/Right L: Sol/Left ● Stokta/In Stock ○ Stokta Yok/Non Stock Item

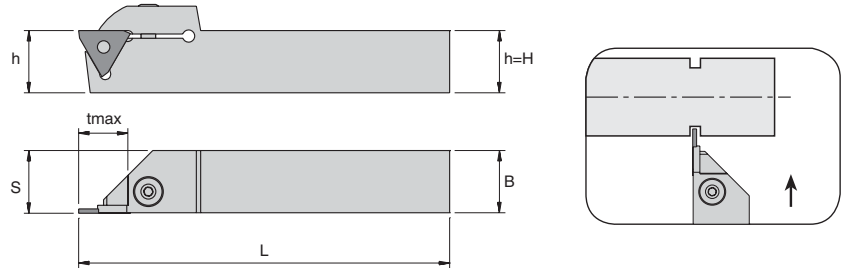
Sipariş Örneği/Ordering Example : 1 ad./pcs. ADKT-TD-R-1212-2-T15

DIŞ ÇAP KANAL AÇMA TAKIMLARI EXTERNAL GROOVING TOOLHOLDERS



Takım Kodu Ordering Code	Stok Stock		Kater Ölçüleri (mm) Dimension (mm)				Kesici Uç Insert	Yedek Parçaları Spare Parts			
	R	L	h=H	B	L	S		t max	Sıkma Vidası Clamp Screw	Pul Stamp	Anahtar Allen Key
ADKT-H22-R/L-1616-(0.5-2)-T6	●	●	16	16	100	16.2	6	HRN / S312 			
ADKT-H22-R/L-2020-(0.5-2)-T6	●	●	20	20	125	20.2	6	(05-2)	2004-M8x1x20	-	AAL-05-4
ADKT-H22-R/L-2525-(0.5-2)-T6	●	●	25	25	150	25.2	6				

R: Sağ/Right L: Sol/Left ● Stokta/In Stock ○ Stokta Yok/Non Stock Item

Sipariş Örneği/Ordering Example : 1 ad./pcs. ADKT-H22-R-1616-(0.5-2)-T6



DIŞ ÇAP ALIN KANAL AÇMA TAKIMLARI

FACE EXTERNAL GROOVING TOOLHOLDERS

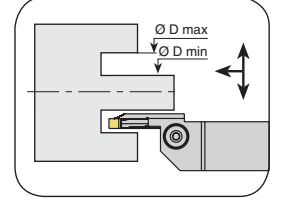
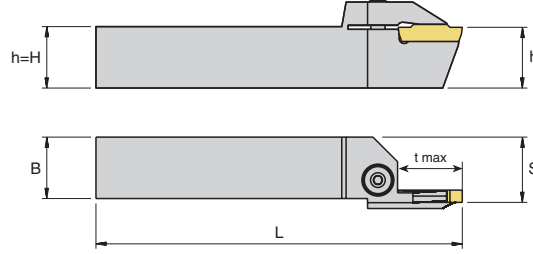

Takım Kodu

Ordering Code

Stok
Stock

Kater Ölçüleri (mm)
Dimension (mm)

Kesici Uç
Insert

Yedek Parçaları
Spare Parts

Sıkma Vidası
Clamp Screw

Pul
Stamp

Anahtar
Allen Key

R	L	h=H	B	L	S	t max	Ø D min	Ø D max
●	●	25	25	150	26.5	17	34	45
●	●	25	25	150	26.5	17	39	55
●	●	25	25	150	26.5	17	49	80
●	●	25	25	150	26.5	17	70	110
●	●	25	25	150	26.5	17	100	150
●	●	25	25	150	26.5	22	50	85
●	●	25	25	150	26.5	22	70	110
●	●	25	25	150	26.5	22	100	150
●	●	25	25	150	26.5	25	70	110
●	●	25	25	150	26.5	25	100	150
●	●	25	25	150	26.5	25	140	200

KRLY / MGM.

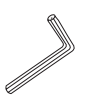
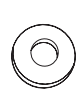
2004-M8x1x20

-

AAL-05-4

R: Sağ/Right L: Sol/Left ● Stokta/In Stock ○ Stokta Yok/Non Stock Item

Sipariş Örneği/Ordering Example : 1 ad./pcs. AAKT-K-R-2525-Ø(34-45)-3-T17

DIŞ ÇAP ALIN KANAL AÇMA TAKIMLARI

FACE EXTERNAL GROOVING TOOLHOLDERS

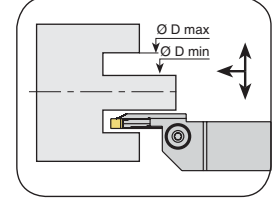
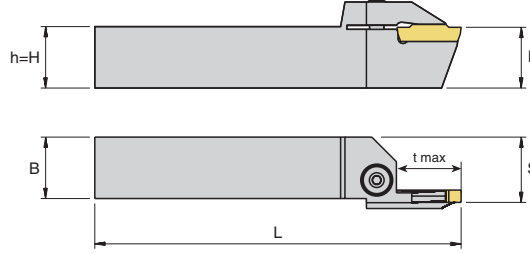

Takım Kodu Ordering Code	Stok Stock		Kater Ölçüleri (mm) Dimension (mm)						Kesici Uç Insert	Yedek Parçaları Spare Parts			
	R	L	h=H	B	L	S	t max	Ø D min		Ø D max	Sıkma Vidası Clamp Screw	Pul Stamp	Anahtar Allen Key
AAKT-ZCC2-R/L-2525-Ø(35-45)-3-T17	●	○	25	25	150	26.5	17	35	45	3			
AAKT-ZCC2-R-2525-Ø(39-55)-3-T17	●	○	25	25	150	26.5	17	39	55				
AAKT-ZCC2-R-2525-Ø(49-80)-3-T17	●	○	25	25	150	26.5	17	49	80				
AAKT-ZCC2-R/L-2525-Ø(70-110)-3-T17	●	○	25	25	150	26.5	17	70	110				
AAKT-ZCC2-R/L-2525-Ø(100-150)-3-T17	●	○	25	25	150	26.5	17	100	150				
AAKT-ZCC2-R/L-2525-Ø(40-60)-4-T22	●	○	25	25	150	26.5	22	40	60	4	2004-M8x1x20	-	AAL-05-4
AAKT-ZCC2-R/L-2525-Ø(52-80)-4-T22	●	○	25	25	150	26.5	22	52	80				
AAKT-ZCC2-R/L-2525-Ø(72-110)-4-T22	●	○	25	25	150	26.5	22	72	110				
AAKT-ZCC2-R/L-2525-Ø(100-150)-4-T22	●	○	25	25	150	26.5	22	100	150				
AAKT-ZCC2-R/L-2525-Ø(140-200)-4-T22	●	○	25	25	150	26.5	22	140	200				
AAKT-ZCC2-R/L-2525-Ø(55-95)-5-T25	●	○	25	25	150	26.5	25	55	95	5			
AAKT-ZCC2-R/L-2525-Ø(85-140)-5-T25	●	○	25	25	150	26.5	25	85	140				
AAKT-ZCC2-R/L-2525-Ø(130-200)-5-T25	●	○	25	25	150	26.5	25	130	200				
AAKT-ZCC2-R/L-2525-Ø(190-400)-5-T25	●	○	25	25	150	26.5	25	190	400				

R: Sağ/Right L: Sol/Left ● Stokta/In Stock ○ Stokta Yok/Non Stock Item

Sipariş Örneği/Ordering Example : 1 ad./pcs. AAKT-ZCC2-R-2525-Ø(35-45)-3-T17

DIŞ ÇAP ALIN KANAL AÇMA TAKIMLARI

FACE EXTERNAL GROOVING TOOLHOLDERS

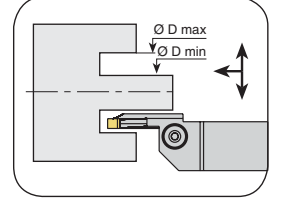
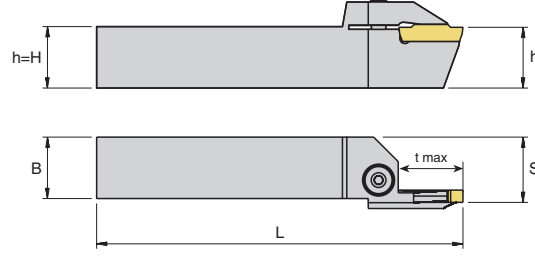

Takım Kodu
Ordering Code

Stok
Stock

Kater Ölçüleri (mm)
Dimension (mm)

Kesici Uç
Insert

Yedek Parçaları
Spare Parts

Sıkma Vidası
Clamp Screw

Pul
Stamp

Anahtar
Allen Key

R

L

h=H

B

L

S

t max

Ø D min

Ø D max

ISCR
GRP-DGN

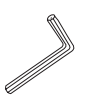
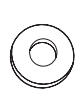

AAKT-IG-R/L-2525-Ø(40-60)-4-T25

○

○

25

25

150

26.5

25

40

60

AAKT-IG-R/L-2525-Ø(52-80)-4-T25

○

○

25

25

150

26.5

25

52

80

AAKT-IG-R/L-2525-Ø(72-110)-4-T25

○

○

25

25

150

26.5

25

72

110

AAKT-IG-R/L-2525-Ø(100-150)-4-T25

○

○

25

25

150

26.5

25

100

150

AAKT-IG-R/L-2525-Ø(140-200)-4-T25

○

○

25

25

150

26.5

25

140

200

AAKT-IG-R/L-2525-Ø(200-800)-4-T25

○

○

25

25

150

26.5

25

200

800

AAKT-IG-R/L-2525-Ø(70-110)-5-T32

●

○

25

25

150

26.5

32

70

110

AAKT-IG-R/L-2525-Ø(110-200)-5-T32

●

○

25

25

150

26.5

32

110

200

AAKT-IG-R/L-2525-Ø(180-800)-5-T32

●

○

25

25

150

26.5

32

180

800

4

2004-M8x1x20

-

AAL-05-4

5

R: Sağ/Right L: Sol/Left ● Stokta/In Stock ○ Stokta Yok/Non Stock Item

Sipariş Örneği/Ordering Example : 1 ad./pcs. AAKT-IG-R/L-2525-Ø(70-110)-5-T32



DELİK İÇİ KANAL AÇMA TAKIMLARI INTERNAL GROOVING TOOLHOLDERS

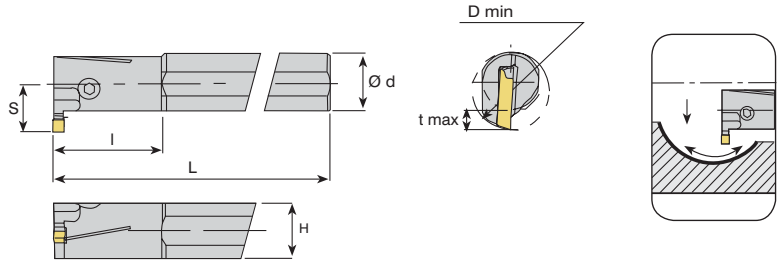

Takım Kodu Ordering Code	Stok Stock		Kater Ölçüleri (mm) Dimension (mm)						Kesici Uç Insert	Yedek Parçaları Spare Parts		
	R	L	d	D	L	I	t _{max}	H		S	Sıkma Vidası Clamp Screw	Anahtar Allen Key
AIKT-K-R/L-16-2-T4	●	●	16	20	150	33	4	15	11.5	KRLY / MGM. 	2503-M4x10	AAL-03-3
AIKT-K-R/L-20-2-T4	●	●	20	25	170	33	4	18	14.5		2503-M4x16	
AIKT-K-R/L-20-3-T6	●	●	20	25	170	33	6	18	15	3	2504-M5x16	AAL-05-4
AIKT-K-R/L-25-3-T6	●	●	25	31	200	45	6	23	18.5		2004-M8x1x20	
AIKT-K-R/L-32-3-T6	●	●	32	37	250	49	6	30	22		2504-M5x16	
AIKT-K-R/L-40-3-T6	●	○	40	45	300	54	6	37	27	2004-M8x1x20		
AIKT-K-R/L-20-4-T6	●	●	20	25	170	34	6	18	14	4	2504-M5x16	
AIKT-K-R/L-25-4-T6	●	●	25	31	200	43	6	23	18.5		2004-M8x1x20	
AIKT-K-R/L-32-4-T6	●	●	32	37	250	43	6	30	22		2504-M5x16	
AIKT-K-R/L-40-4-T6	●	●	40	45	300	54	6	37	27		2004-M8x1x20	
AIKT-K-R/L-25-5-T7	●	●	25	31	200	43	7	23	18.5	5	2504-M5x16	
AIKT-K-R/L-32-5-T7	●	●	32	37	250	50	7	30	22		2004-M8x1x20	
AIKT-K-R/L-40-5-T7	●	●	40	45	300	54	7	37	27		2004-M8x1x20	

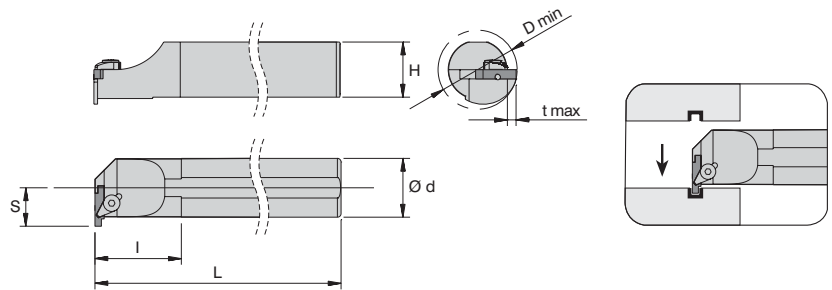

Takım Kodu Ordering Code	Stok Stock		Kater Ölçüleri (mm) Dimension (mm)						Kesici Uç Insert	Yedek Parçaları Spare Parts					
	R	L	d	D	L	I	t _{max}	H		S	Baskı Parçası Wedge Clamp	Sıkma Vidası Clamp Screw	Yay Spring	Anahtar Allen Key	
AIKT-154.91-R/L-16-3-T4	●	●	16	20	150	38	4	15	10.5	SNDVK / 154.91 	ACK-06	AKV-10-M6x15	-	AAL-05-4	
AIKT-154.91-R/L-20-3-T4	●	●	20	25	170	40	4	18	13.5						3
AIKT-154.91-R/L-25-3-T4	●	●	25	31	200	42	4	23	16.5						5
AIKT-154.91-R/L-25-5-T5	●	●	25	31	200	42	5	23	16.5	5	ACK-03	AKV-07-M6x20	-	AAL-03-3	
AIKT-154.91-R/L-32-5-T5	●	●	32	39	250	49	5	30	21.5						

R: Sağ/Right L: Sol/Left ● Stokta/In Stock ○ Stokta Yok/Non Stock Item

Sipariş Örneği/Ordering Example : 1 ad./pcs. AIKT-154.91-R-16-3-T4

DELİK İÇİ KANAL AÇMA TAKIMLARI

INTERNAL GROOVING TOOLHOLDERS

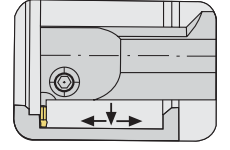
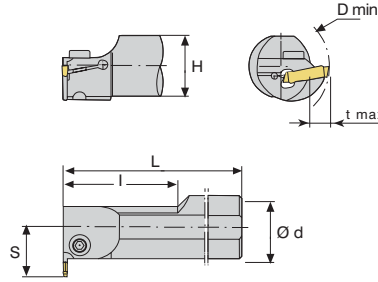

Takım Kodu Ordering Code	Stok Stock		Kater Ölçüleri (mm) Dimension (mm)						Kesici Uç Insert	Yedek Parçaları Spare Parts		
	R	L	d	D	L	I	t max	H		S	Sıkma Vidası Clamp Screw	Anahtar Allen Key
										HRN / S229		
AIKT-H-R/L-25-3-T7	●	●	25	31	200	43	7	23	18.9	3	2504-M5x16	AAL-05-4
AIKT-H-R/L-32-3-T7	●	○	32	37	250	65	7	30	21.5		2004-M8x1x20	
AIKT-H-R/L-40-3-T7	●	○	40	45	300	50	7	37	26.5			
AIKT-H-R/L-25-4-T7	●	○	25	31	200	40	7	23	18.9	4	2504-M5x16	
AIKT-H-R/L-32-4-T7	●	●	32	37	250	65	7	30	21.5		2004-M8x1x20	
AIKT-H-R/L-40-4-T7	●	○	40	45	300	50	7	37	26.5			
AIKT-H-R/L-25-5-T7	●	○	25	31	200	45	7	23	18.9	5	2504-M5x16	
AIKT-H-R/L-32-5-T7	●	○	32	37	250	50	7	30	21.5		2004-M8x1x20	
AIKT-H-R/L-40-5-T7	●	○	40	45	300	70	7	37	26.5			

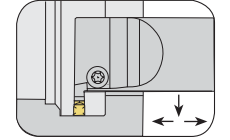
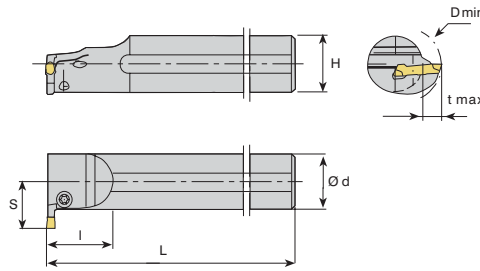

Takım Kodu Ordering Code	Stok Stock		Kater Ölçüleri (mm) Dimension (mm)						Kesici Uç Insert	Yedek Parçaları Spare Parts		
	R	L	d	D	L	I	t max	H		S	Sıkma Vidası Clamp Screw	Anahtar Allen Key
										HRN / S223-S224		
AIKT-HK-R/L-20-2-T6	●	○	20	25	170	32	6	18	15	2	2503-M4x16	AAL-03-3
AIKT-HK-R/L-25-2-T6	●	○	25	31	200	42	6	23	18.9		2504-M5x16	
AIKT-HK-R/L-20-3-T6	●	○	20	25	170	33	6	18	15	3	2504-M5x16	AAL-05-4
AIKT-HK-R/L-25-3-T6	●	○	25	31	200	43	6	23	18.9		2004-M8x1x20	
AIKT-HK-R/L-32-3-T6	●	○	32	37	250	50	6	30	21.5		2504-M5x16	
AIKT-HK-R/L-20-4-T6	●	○	20	25	170	34	6	18	15	4	2504-M5x16	
AIKT-HK-R/L-25-4-T6	●	○	25	31	200	40	6	23	18.9		2004-M8x1x20	
AIKT-HK-R/L-32-4-T6	●	○	32	37	250	50	6	30	21.5			
AIKT-HS223-R/L-20-2-T5	●	○	20	25	170	32	5	18	15	2	2503-M4x16	AAL-03-3
AIKT-HS223-R/L-25-2-T5	●	○	25	31	200	42	5	23	18		2504-M5x16	
AIKT-HS223-R/L-20-3-T6	●	○	20	25	170	32	6	18	15	3	2504-M5x16	AAL-05-4
AIKT-HS223-R/L-20-3-T6	●	○	25	31	200	42	6	23	18			







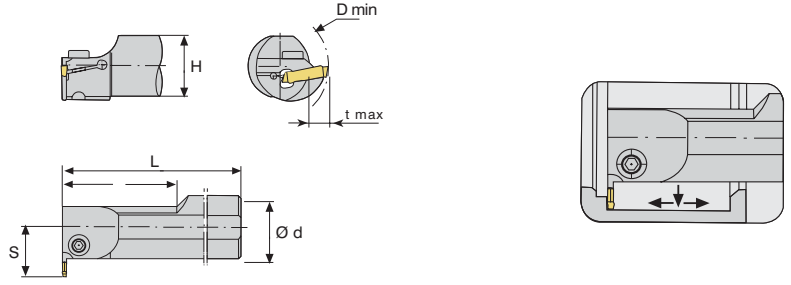

R: Sağ/Right L: Sol/Left ● Stokta/In Stock ○ Stokta Yok/Non Stock Item

Sipariş Örneği/Ordering Example : 1 ad./pcs. AIKT-HK-R-20-2-T6







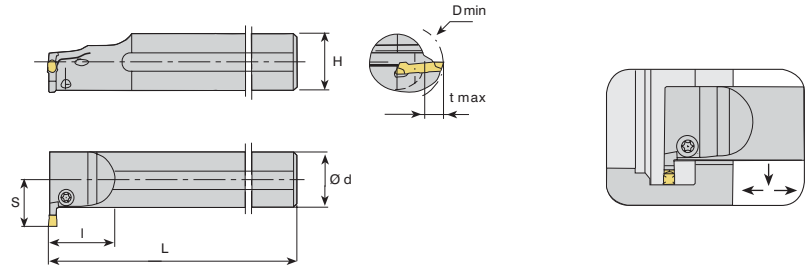

DELİK İÇİ KANAL AÇMA TAKIMLARI

INTERNAL GROOVING TOOLHOLDERS



Takım Kodu Ordering Code	Stok Stock		Kater Ölçüleri (mm) Dimension (mm)						Kesici Uç Insert	Yedek Parçaları Spare Parts		
	R	L	d	D	L	I	t max	H		S	Sıkma Vidası Clamp Screw	Anahtar Allen Key
AIKT-KM-R/L-20-2-T7	●	○	20	25	200	40	7	18	13	2 		
AIKT-KM-R/L-20-3-T7	●	○	20	25	200	40	7	18	13			
AIKT-KM-R/L-25-3-T10	●	○	25	32	200	50	10	23	17	3 		
AIKT-KM-R/L-32-3-T12	●	○	32	40	250	64	12	30	22			
AIKT-KM-R/L-40-3-T12	●	○	40	52	300	80	12	37	30	4 		
AIKT-KM-R/L-20-4-T7	●	○	20	25	200	40	7	18	13			



Takım Kodu Ordering Code	Stok Stock		Kater Ölçüleri (mm) Dimension (mm)						Kesici Uç Insert	Yedek Parçaları Spare Parts		
	R	L	d	D	L	I	t max	H		S	Sıkma Vidası Clamp Screw	Anahtar Allen Key
AIKT-ZCC2-R/L-20-3-T5	●	○	20	25	170	32	5	18	15	3 		
AIKT-ZCC2-R/L-25-3-T5	●	○	25	31	200	42	5	23	18			
AIKT-ZCC2-R/L-32-3-T6	●	○	32	45	250	42	6	30	22	4 		
AIKT-ZCC2-R/L-25-4-T6	●	○	25	31	200	42	6	23	18			
AIKT-ZCC2-R/L-32-4-T7	●	○	32	37	250	42	7	30	22	5 		
AIKT-ZCC2-R/L-32-5-T8	●	○	32	37	250	42	8	30	22			
AIKT-ZCC2-R/L-40-5-T8	●	○	40	45	300	53	8	37	27			

R: Sağ/Right L: Sol/Left ● Stokta/In Stock ○ Stokta Yok/Non Stock Item

Sipariş Örneği/Ordering Example : 1 ad./pcs. AIKT-ZCC2-R-20-3-T5



U-DRILL

TAKMA UÇLU MATKAPLAR
U-DRILL SYSTEM

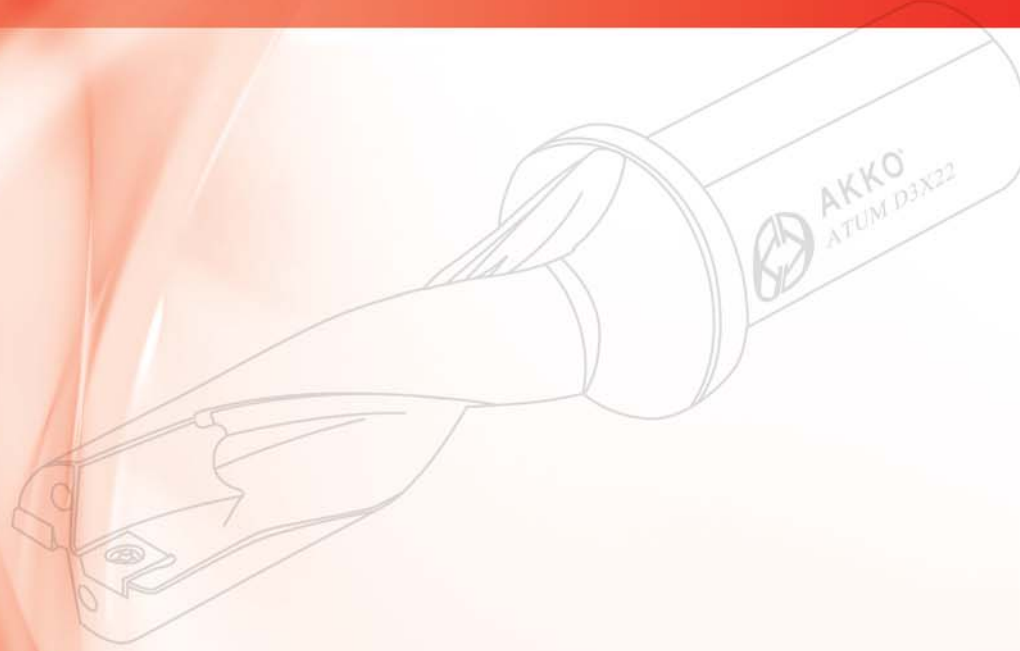



AKKO **A** **TUM** **16** x **D3**

S **P** **M** **T** **06** **02** **04**

2 Kesiş Stili / Cutter Style

TUM : Takma Uçlu Matkap / U-Drill

3 Takım Çapı / Tool Diameter

4 Delme Derinliği / Drilling Depth

5 Uç Şekli / Insert Form

W **S**

6 Serbest Uç Açısı / Clearance angle of Insert

C **P**

8 Uç Tipi / Type of Insert

A J T
 $\beta = 70-90^\circ$ $\beta = 70-90^\circ$ $\beta = 40-60^\circ$

B M U
 $\beta = 70-90^\circ$ $\beta = 40-60^\circ$ $\beta = 40-60^\circ$

C N W
 $\beta = 70-90^\circ$ $\beta = 40-60^\circ$ $\beta = 40-60^\circ$

F Q X Special / Özel

G R

H

$\beta = 70-90^\circ$

10 Kalınlık / Thickness

01 s = 1.59
T1 s = 1.98
02 s = 2.38
T2 s = 2.78
03 s = 3.18
T3 s = 3.97
04 s = 4.76
05 s = 5.56
06 s = 6.35
07 s = 7.94
09 s = 9.52

7 Toleranslar / Tolerance Classes

	d	m	t
A	± 0.025	± 0.005	± 0.025
C	± 0.025	± 0.013	± 0.025
E	± 0.025	± 0.025	± 0.025
F	± 0.013	± 0.005	± 0.025
G	± 0.025	± 0.025	± 0.130
H	± 0.013	± 0.013	± 0.025
J	$\pm 0.05-0.15$	± 0.005	± 0.025
K	$\pm 0.05-0.15$	± 0.013	± 0.025
L	$\pm 0.05-0.15$	± 0.025	± 0.025
M	$\pm 0.05-0.15$	$\pm 0.08-0.20$	± 0.130
N	$\pm 0.05-0.15$	$\pm 0.08-0.20$	± 0.025
U	$\pm 0.08-0.25$	$\pm 0.13-0.38$	± 0.130

d : Daire Ölçüsü / Inscribed Circle
m : Şekle Göre / Refer to Figure
t : Kalınlık / Thickness

9 Kesme Kenar Uzunluğu / Cutting Edge Length

11 Köşe Konfigürasyonu / Corner Radius

01 r = 0.1
02 r = 0.2
04 r = 0.4
08 r = 0.8
12 r = 1.2
16 r = 1.6
24 r = 2.4

TAKMA UÇLU MATKAPLAR

U-DRILL SYSTEM



Delme Derinliği = 2xÇap
Drilling Depth = 2xDiameter

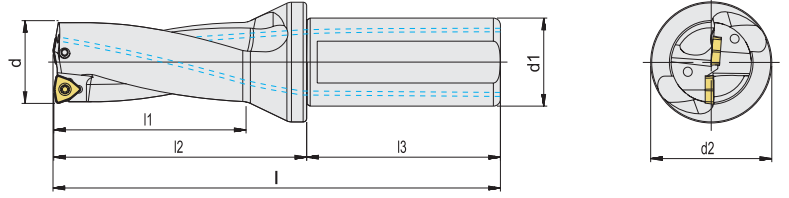

Takım Kodu Ordering Code	Stok Stock	Takım Ölçüleri (mm) Dimension (mm)							Kesici Uç Insert	Yedek Parçaları Spare Parts	
		d	d ₁	d ₂	l	l ₁	l ₂	l ₃		Sıkma Vidası Clamp Screw	Tork Anahtar Torx Key
ATUM 16XD2 WCM. 030208	●	16	25	34	108	32	52	56	WCM. 030208	3008-M2.5x6	80-T08
ATUM 16.5XD2 WCM. 030208	●	16.5	25	34	110	34	54	56			
ATUM 17XD2 WCM. 030208	●	17	25	34	110	34	54	56			
ATUM 17.5XD2 WCM. 030208	●	17.5	25	34	113	36	57	56			
ATUM 18XD2 WCM. 030208	●	18	25	34	113	36	57	56			
ATUM 18.5XD2 WCM. 030208	●	18.5	25	34	115	38	59	56			
ATUM 19XD2 WCM. 030208	●	19	25	34	115	38	59	56			
ATUM 19.5XD2 WCM. 030208	●	19.5	25	34	119	40	63	56			
ATUM 20XD2 WCM. 040208	●	20	25	34	119	40	63	56	WCM. 040208	3008-M2.5x6	80-T08
ATUM 20.5XD2 WCM. 040208	●	20.5	25	34	121	42	65	56			
ATUM 21XD2 WCM. 040208	●	21	25	34	121	42	65	56			
ATUM 21.5XD2 WCM. 040208	●	21.5	25	34	123	44	67	56			
ATUM 22XD2 WCM. 040208	●	22	25	34	123	44	67	56			
ATUM 22.5XD2 WCM. 040208	●	22.5	25	34	127	46	71	56			
ATUM 23XD2 WCM. 040208	●	23	25	34	127	46	71	56			
ATUM 23.5XD2 WCM. 040208	●	23.5	25	34	130	48	74	56			
ATUM 24XD2 WCM. 050308	●	24	25	34	130	48	74	56	WCM. 050308	1008-M3x9	
ATUM 24.5XD2 WCM. 050308	●	24.5	25	34	133	48	77	56			
ATUM 25XD2 WCM. 050308	●	25	25	34	133	50	77	56			
ATUM 25.5XD2 WCM. 050308	●	25.5	25	34	135	52	79	56			
ATUM 26XD2 WCM. 050308	●	26	25	34	135	52	79	56			
ATUM 26.5XD2 WCM. 050308	●	26.5	25	34	137	54	81	56			
ATUM 27XD2 WCM. 050308	●	27	25	34	137	54	81	56			
ATUM 27.5XD2 WCM. 050308	●	27.5	25	34	140	56	84	56			
ATUM 28XD2 WCM. 050308	●	28	25	34	140	56	84	56			
ATUM 28.5XD2 WCM. 050308	●	28.5	25	34	142	58	86	56			
ATUM 29XD2 WCM. 050308	●	29	25	34	142	58	86	56			
ATUM 29.5XD2 WCM. 050308	●	29.5	25	34	151	60	91	56			

R: Sağ/Right L: Sol/Left ● Stokta/In Stock ○ Stokta Yok/Non Stock Item

Sipariş Örneği/Ordering Example : 1 ad./pcs. ATUM 16xD2 WCM. 030208
Takma Uçlu Matkap Kullanım Kılavuzu : S 143 / User's Guide For U-Drills : P 143

TAKMA UÇLU MATKAPLAR

U-DRILL SYSTEM



Delme Derinliği = 2xÇap
Drilling Depth = 2xDiameter

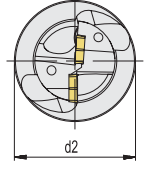
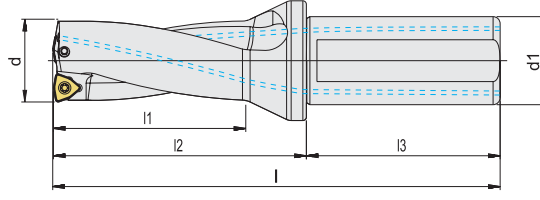

Takım Kodu Ordering Code	Stok Stock	Takım Ölçüleri (mm) Dimension (mm)							Kesici Uç Insert	Yedek Parçaları Spare Parts	
		d	d ₁	d ₂	l	l ₁	l ₂	l ₃		Sıkma Vidası Clamp Screw	Tork Anahtar Torx Key
ATUM 30XD2 WCM. 06T308	●	30	32	44	151	60	91	60	WCM. 06T308	1510-M3.5x9	80-T10
ATUM 31XD2 WCM. 06T308	●	31	32	44	154	62	94	60			
ATUM 32XD2 WCM. 06T308	●	32	32	44	156	64	96	60			
ATUM 33XD2 WCM. 06T308	●	33	32	44	159	66	99	60			
ATUM 34XD2 WCM. 06T308	●	34	32	44	161	68	101	60			
ATUM 35XD2 WCM. 06T308	●	35	32	44	164	70	104	60			
ATUM 36XD2 WCM. 06T308	●	36	32	44	167	72	107	60			
ATUM 37XD2 WCM. 06T308	●	37	32	44	170	74	110	60			
ATUM 38XD2 WCM. 06T308	●	38	32	44	173	76	113	60			
ATUM 39XD2 WCM. 06T308	●	39	32	44	175	78	115	60			
ATUM 40XD2 WCM. 06T308	●	40	32	44	178	80	118	60			
ATUM 41XD2 WCM. 06T308	●	41	32	44	181	82	121	60			
ATUM 42XD2 WCM. 06T308	●	42	32	44	183	84	123	60			
ATUM 43XD2 WCM. 06T308	●	43	32	44	186	86	126	60			
ATUM 44XD2 WCM. 06T308	●	44	32	44	188	88	128	60			
ATUM 45XD2 WCM. 080412	●	45	40	54	202	90	132	70	WCM. 080412	1515-M4x11	80-T15
ATUM 46XD2 WCM. 080412	●	46	40	54	205	92	135	70			
ATUM 47XD2 WCM. 080412	●	47	40	54	207	94	137	70			
ATUM 48XD2 WCM. 080412	●	48	40	54	210	96	140	70			
ATUM 49XD2 WCM. 080412	●	49	40	54	212	98	142	70			
ATUM 50XD2 WCM. 080412	●	50	40	54	215	100	145	70			
ATUM 51XD2 WCM. 080412	●	51	40	60	217	102	147	70			
ATUM 52XD2 WCM. 080412	●	52	40	60	220	104	150	70			
ATUM 53XD2 WCM. 080412	●	53	40	60	222	106	152	70			
ATUM 54XD2 WCM. 080412	●	54	40	60	225	108	155	70			
ATUM 55XD2 WCM. 080412	●	55	40	60	227	110	157	70			
ATUM 56XD2 WCM. 080412	●	56	40	60	230	112	160	70			
ATUM 57XD2 WCM. 080412	●	57	40	60	232	114	162	70			
ATUM 58XD2 WCM. 080412	●	58	40	60	235	116	165	70			
ATUM 59XD2 WCM. 080412	●	59	40	60	237	118	167	70			
ATUM 60XD2 WCM. 080412	●	60	40	60	240	120	170	70			

R: Sağ/Right L: Sol/Left ● Stokta/In Stock ○ Stokta Yok/Non Stock Item

Sipariş Örneği/Ordering Example : 1 ad./pcs. ATUM 30xD2 WCM. 06T308
Takma Uçlu Matkap Kullanım Kılavuzu : S 143 / User's Guide For U-Drills : P 143

TAKMA UÇLU MATKAPLAR

U-DRILL SYSTEM



Delme Derinliği = 3xÇap
Drilling Depth = 3xDiameter

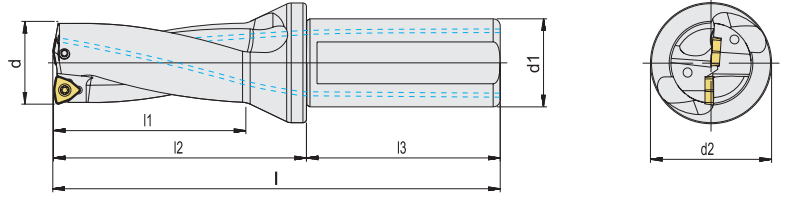

Takım Kodu
Ordering Code

Stok
Stock

Takım Ölçüleri (mm)
Dimension (mm)

Kesici Uç
Insert

Yedek Parçaları
Spare Parts

Sıkma Vidası
Clamp Screw

Tork Anahtar
Torx Key

d d₁ d₂ l l₁ l₂ l₃

WCM. 030208

WCM. 040208

WCM. 050308

3008-M2.5x6

80-T08

1008-M3x9

Takım Kodu Ordering Code	Stok Stock	d	d ₁	d ₂	l	l ₁	l ₂	l ₃	Kesici Uç Insert	Yedek Parçaları Spare Parts	Tork Anahtar Torx Key
ATUM 16XD3 WCM. 030208	●	16	25	34	124	48	68	56	WCM. 030208	3008-M2.5x6	80-T08
ATUM 16.5XD3 WCM. 030208	●	16.5	25	34	127	51	71	56			
ATUM 17XD3 WCM. 030208	●	17	25	34	127	51	71	56			
ATUM 17.5XD3 WCM. 030208	●	17.5	25	34	131	54	75	56			
ATUM 18XD3 WCM. 030208	●	18	25	34	131	54	75	56			
ATUM 18.5XD3 WCM. 030208	●	18.5	25	34	134	57	78	56			
ATUM 19XD3 WCM. 030208	●	19	25	34	134	57	78	56			
ATUM 19.5XD3 WCM. 030208	●	19.5	25	34	139	60	83	56			
ATUM 20XD3 WCM. 040208	●	20	25	34	139	60	83	56			
ATUM 20.5XD3 WCM. 040208	●	20.5	25	34	142	63	86	56			
ATUM 21XD3 WCM. 040208	●	21	25	34	142	63	86	56			
ATUM 21.5XD3 WCM. 040208	●	21.5	25	34	145	66	89	56			
ATUM 22XD3 WCM. 040208	●	22	25	34	145	66	89	56			
ATUM 22.5XD3 WCM. 040208	●	22.5	25	34	150	69	94	56			
ATUM 23XD3 WCM. 040208	●	23	25	34	150	69	94	56			
ATUM 23.5XD3 WCM. 040208	●	23.5	25	34	154	72	98	56			
ATUM 24XD3 WCM. 050308	●	24	25	34	154	72	98	56			
ATUM 24.5XD3 WCM. 050308	●	24.5	25	34	158	75	102	56			
ATUM 25XD3 WCM. 050308	●	25	25	34	158	75	102	56			
ATUM 25.5XD3 WCM. 050308	●	25.5	25	34	161	78	105	56			
ATUM 26XD3 WCM. 050308	●	26	25	34	161	78	105	56			
ATUM 26.5XD3 WCM. 050308	●	26.5	25	34	164	81	108	56			
ATUM 27XD3 WCM. 050308	●	27	25	34	164	81	108	56			
ATUM 27.5XD3 WCM. 050308	●	27.5	25	34	168	84	112	56			
ATUM 28XD3 WCM. 050308	●	28	25	34	168	84	112	56			
ATUM 28.5XD3 WCM. 050308	●	28.5	25	34	171	87	115	56			
ATUM 29XD3 WCM. 050308	●	29	25	34	171	87	115	56			
ATUM 29.5XD3 WCM. 050308	●	29.5	25	34	177	90	121	56			

R: Sağ/Right L: Sol/Left ● Stokta/In Stock ○ Stokta Yok/Non Stock Item

Sipariş Örneği/Ordering Example : 1 ad./pcs. ATUM 16xD3 WCM. 030208
Takma Uçlu Matkap Kullanım Kılavuzu : S 143 / User's Guide For U-Drills : P 143



Delme Derinliği = 3xÇap
Drilling Depth = 3xDiameter

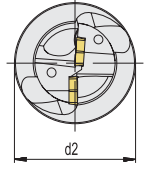
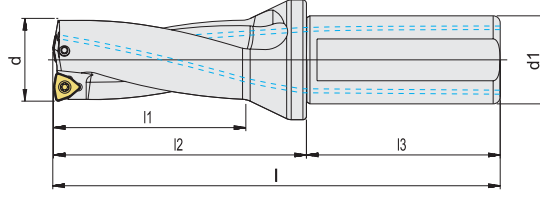

Takım Kodu Ordering Code	Stok Stock	Takım Ölçüleri (mm) Dimension (mm)							Kesici Uç Insert	Yedek Parçaları Spare Parts	
		d	d ₁	d ₂	l	l ₁	l ₂	l ₃		Sıkma Vidası Clamp Screw	Tork Anahtar Torx Key
ATUM 30XD3 WCM. 06T308	●	30	32	44	181	90	121	60	 WCM. 06T308	 1510-M3.5x9	 80-T10
ATUM 31XD3 WCM. 06T308	●	31	32	44	185	93	125	60			
ATUM 32XD3 WCM. 06T308	●	32	32	44	188	96	128	60			
ATUM 33XD3 WCM. 06T308	●	33	32	44	192	99	132	60			
ATUM 34XD3 WCM. 06T308	●	34	32	44	195	102	135	60			
ATUM 35XD3 WCM. 06T308	●	35	32	44	199	105	139	60			
ATUM 36XD3 WCM. 06T308	●	36	32	44	203	108	143	60			
ATUM 37XD3 WCM. 06T308	●	37	32	44	207	111	147	60			
ATUM 38XD3 WCM. 06T308	●	38	32	44	211	114	151	60			
ATUM 39XD3 WCM. 06T308	●	39	32	44	214	117	154	60			
ATUM 40XD3 WCM. 06T308	●	40	32	44	218	120	158	60			
ATUM 41XD3 WCM. 06T308	●	41	32	44	222	123	162	60			
ATUM 42XD3 WCM. 06T308	●	42	32	44	225	126	165	60			
ATUM 43XD3 WCM. 06T308	●	43	32	44	229	129	169	60			
ATUM 44XD3 WCM. 06T308	●	44	32	44	232	132	172	60			
ATUM 45XD3 WCM. 080412	●	45	40	54	247	135	177	70			
ATUM 46XD3 WCM. 080412	●	46	40	54	251	138	181	70			
ATUM 47XD3 WCM. 080412	●	47	40	54	254	141	184	70			
ATUM 48XD3 WCM. 080412	●	48	40	54	258	144	188	70			
ATUM 49XD3 WCM. 080412	●	49	40	54	261	147	191	70			
ATUM 50XD3 WCM. 080412	●	50	40	54	265	150	195	70			
ATUM 51XD3 WCM. 080412	●	51	40	60	268	153	198	70			
ATUM 52XD3 WCM. 080412	●	52	40	60	271	156	201	70			
ATUM 53XD3 WCM. 080412	●	53	40	60	274	159	204	70			
ATUM 54XD3 WCM. 080412	●	54	40	60	277	162	207	70			
ATUM 55XD3 WCM. 080412	●	55	40	60	280	165	210	70			
ATUM 56XD3 WCM. 080412	●	56	40	60	283	168	213	70			
ATUM 57XD3 WCM. 080412	●	57	40	60	286	171	216	70			
ATUM 58XD3 WCM. 080412	●	58	40	60	289	174	219	70			
ATUM 59XD3 WCM. 080412	●	59	40	60	292	177	222	70			
ATUM 60XD3 WCM. 080412	●	60	40	60	295	180	225	70			

R: Sağ/Right L: Sol/Left ● Stokta/In Stock ○ Stokta Yok/Non Stock Item

Sipariş Örneği/Ordering Example : 1 ad./pcs. ATUM 30xD3 WCM. 06T308
Takma Uçlu Matkap Kullanım Kılavuzu : S 143 / User's Guide For U-Drills : P 143

TAKMA UÇLU MATKAPLAR

U-DRILL SYSTEM



Delme Derinliği = 4xÇap
Drilling Depth = 4xDiameter

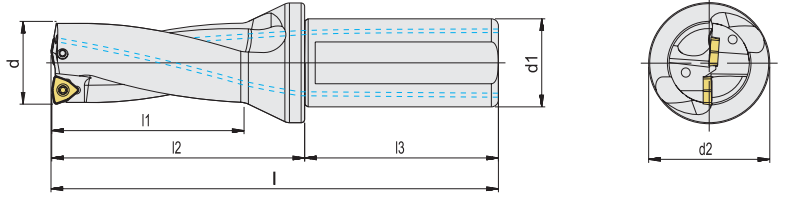

Takım Kodu Ordering Code	Stok Stock	Takım Ölçüleri (mm) Dimension (mm)								Kesici Uç Insert	Yedek Parçaları Spare Parts	
		d	d ₁	d ₂	l	l ₁	l ₂	l ₃	Sıkma Vidası Clamp Screw		Tork Anahtar Torx Key	
ATUM 16XD4 WCM. 030208	●	16	25	34	140	64	84	56	WCM. 030208			
ATUM 16.5XD4 WCM. 030208	○	16.5	25	34	144	68	88	56				
ATUM 17XD4 WCM. 030208	●	17	25	34	144	68	88	56				
ATUM 17.5XD4 WCM. 030208	○	17.5	25	34	149	72	93	56				
ATUM 18XD4 WCM. 030208	●	18	25	34	149	72	93	56				
ATUM 18.5XD4 WCM. 030208	○	18.5	25	34	153	76	97	56				
ATUM 19XD4 WCM. 030208	●	19	25	34	153	76	97	56				
ATUM 19.5XD4 WCM. 030208	○	19.5	25	34	159	80	103	56				
ATUM 20XD4 WCM. 040208	●	20	25	34	159	80	103	56	WCM. 040208	3008-M2.5x6	80-T08	
ATUM 20.5XD4 WCM. 040208	○	20.5	25	34	163	84	107	56				
ATUM 21XD4 WCM. 040208	●	21	25	34	163	84	107	56				
ATUM 21.5XD4 WCM. 040208	○	21.5	25	34	167	88	111	56				
ATUM 22XD4 WCM. 040208	●	22	25	34	167	88	111	56				
ATUM 22.5XD4 WCM. 040208	○	22.5	25	34	173	92	117	56				
ATUM 23XD4 WCM. 040208	●	23	25	34	173	92	117	56				
ATUM 23.5XD4 WCM. 040208	○	23.5	25	34	178	96	122	56				
ATUM 24XD4 WCM. 050308	●	24	25	34	178	96	122	56	WCM. 050308	1008-M3x9		
ATUM 24.5XD4 WCM. 050308	○	24.5	25	34	183	100	127	56				
ATUM 25XD4 WCM. 050308	●	25	25	34	183	100	127	56				
ATUM 25.5XD4 WCM. 050308	○	25.5	25	34	187	104	131	56				
ATUM 26XD4 WCM. 050308	●	26	25	34	187	104	131	56				
ATUM 26.5XD4 WCM. 050308	○	26.5	25	34	191	108	135	56				
ATUM 27XD4 WCM. 050308	●	27	25	34	191	108	135	56				
ATUM 27.5XD4 WCM. 050308	○	27.5	25	34	196	112	140	56				
ATUM 28XD4 WCM. 050308	●	28	25	34	196	112	140	56	WCM. 06T308	1510-M3.5x9	80-T10	
ATUM 28.5XD4 WCM. 050308	○	28.5	25	34	200	116	144	56				
ATUM 29XD4 WCM. 050308	●	29	25	34	200	116	144	56				
ATUM 29.5XD4 WCM. 050308	○	29.5	25	34	207	120	151	56				
ATUM 30XD4 WCM. 06T308	●	30	32	44	211	120	151	60				
ATUM 31XD4 WCM. 06T308	●	31	32	44	216	124	156	60				
ATUM 32XD4 WCM. 06T308	●	32	32	44	220	128	160	60				
ATUM 33XD4 WCM. 06T308	●	33	32	44	225	132	165	60				
ATUM 34XD4 WCM. 06T308	●	34	32	44	229	136	169	60	WCM. 080412	1515-M4x11	80-T15	
ATUM 35XD4 WCM. 06T308	●	35	32	44	234	140	174	60				
ATUM 36XD4 WCM. 06T308	●	36	32	44	239	144	179	60				
ATUM 37XD4 WCM. 06T308	●	37	32	44	244	148	184	60				
ATUM 38XD4 WCM. 06T308	●	38	32	44	249	152	189	60				
ATUM 39XD4 WCM. 06T308	●	39	32	44	253	156	193	60				
ATUM 40XD4 WCM. 06T308	●	40	32	44	258	160	198	60				
ATUM 41XD4 WCM. 06T308	●	41	32	44	263	164	203	60				
ATUM 42XD4 WCM. 06T308	●	42	32	44	267	168	207	60	WCM. 080412	1515-M4x11	80-T15	
ATUM 43XD4 WCM. 06T308	●	43	32	44	272	172	212	60				
ATUM 44XD4 WCM. 06T308	●	44	32	44	276	176	216	60				
ATUM 45XD4 WCM. 080412	●	45	40	54	292	180	222	70				
ATUM 46XD4 WCM. 080412	●	46	40	54	297	184	227	70				
ATUM 47XD4 WCM. 080412	●	47	40	54	301	188	231	70				
ATUM 48XD4 WCM. 080412	●	48	40	54	306	192	236	70				
ATUM 49XD4 WCM. 080412	●	49	40	54	310	196	240	70				
ATUM 50XD4 WCM. 080412	●	50	40	54	315	200	245	70				

R: Sağ/Right L: Sol/Left ● Stokta/In Stock ○ Stokta Yok/Non Stock Item

Sipariş Örneği/Ordering Example : 1 ad./pcs. ATUM 16XD4 WCM. 030208
Takma Uçlu Matkap Kullanım Kılavuzu : S 143 / User's Guide For U-Drills : P 143



Delme Derinliği = 2xÇap
Drilling Depth = 2xDiameter

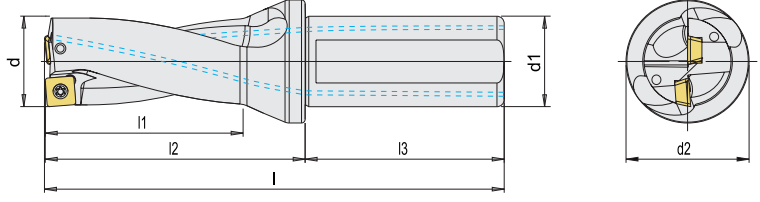

Takım Kodu Ordering Code	Stok Stock	Takım Ölçüleri (mm) Dimension (mm)							Kesici Uç Insert	Yedek Parçaları Spare Parts	
		d	d ₁	d ₂	l	l ₁	l ₂	l ₃		Sıkma Vidası Clamp Screw	Tork Anahtar Torx Key
ATUM 13XD2 SPMT 050203	○	13	20	25	94	26	44	50	SPMT 050203	3006-M2x4	80-T06
ATUM 13.5xD2 SPMT 050203	○	13.5	20	25	96	28	46	50			
ATUM 14XD2 SPMT 050203	○	14	20	25	96	28	46	50			
ATUM 14.5XD2 SPMT 050203	○	14.5	20	25	99	30	49	50			
ATUM 15XD2 SPMT 050203	○	15	20	25	99	30	49	50			
ATUM 15.5XD2 SPMT 050203	○	15.5	20	25	102	32	52	50	SPMT 060204	3007-M2.2x5	80-T07
ATUM 16XD2 SPMT 060204	○	16	25	34	108	32	52	56			
ATUM 16.5XD2 SPMT 060204	○	16.5	25	34	110	34	54	56			
ATUM 17XD2 SPMT 060204	○	17	25	34	110	34	54	56			
ATUM 17.5XD2 SPMT 060204	○	17.5	25	34	113	36	57	56			
ATUM 18XD2 SPMT 060204	○	18	25	34	113	36	57	56			
ATUM 18.5XD2 SPMT 060204	○	18.5	25	34	115	38	59	56			
ATUM 19XD2 SPMT 060204	○	19	25	34	115	38	59	56			
ATUM 19.5XD2 SPMT 060204	○	19.5	25	34	119	40	63	56			
ATUM 20XD2 SPMT 060204	○	20	25	34	119	40	63	56			
ATUM 20.5XD2 SPMT 060204	○	20.5	25	34	121	42	65	56	SPMT 070204	3008-M2.5x6	80-T08
ATUM 21XD2 SPMT 060204	○	21	25	34	121	42	65	56			
ATUM 21.5XD2 SPMT 060204	○	21.5	25	34	123	44	67	56			
ATUM 22XD2 SPMT 070204	○	22	25	34	123	44	67	56			
ATUM 22.5XD2 SPMT 070204	○	22.5	25	34	127	46	71	56			
ATUM 23XD2 SPMT 070204	○	23	25	34	127	46	71	56			
ATUM 23.5XD2 SPMT 070204	○	23.5	25	34	130	48	74	56			
ATUM 24XD2 SPMT 070204	○	24	25	34	130	48	74	56			
ATUM 24.5XD2 SPMT 070204	○	24.5	25	34	133	50	77	56			
ATUM 25XD2 SPMT 070204	○	25	25	34	133	50	77	56			

R: Sağ/Right L: Sol/Left ● Stokta/In Stock ○ Stokta Yok/Non Stock Item

Sipariş Örneği/Ordering Example : 1 ad./pcs. ATUM 13xD2 SPMT 050203
Takma Uçlu Matkap Kullanım Kılavuzu : S 143 / User's Guide For U-Drills : P 143



TAKMA UÇLU MATKAPLAR

U-DRILL SYSTEM



Delme Derinliği = 3xÇap
4xÇap
Drilling Depth = 3xDiameter
4xDiameter

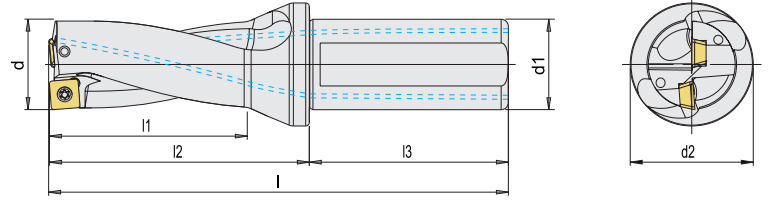

Takım Kodu Ordering Code	Stok Stock	Takım Ölçüleri (mm) Dimension (mm)									Kesici Uç Insert	Yedek Parçaları Spare Parts				
		d	d ₁	d ₂	l	l ₁	l ₂	l ₃	Sıkma Vidası Clamp Screw	Tork Anahtar Torx Key						
ATUM 13XD3 SPMT 050203	●	13	20	25	107	39	57	50	SPMT 050203		3006-M2x4	80-T06				
ATUM 13.5XD3 SPMT 050203	●	13.5	20	25	110	42	60	50								
ATUM 14XD3 SPMT 050203	●	14	20	25	110	42	60	50								
ATUM 14.5XD3 SPMT 050203	●	14.5	20	25	113	45	63	50								
ATUM 15XD3 SPMT 050203	●	15	20	25	113	45	63	50								
ATUM 15.5XD3 SPMT 050203	●	15.5	20	25	118	48	68	50								
ATUM 16XD3 SPMT 060204	●	16	25	34	124	48	68	56	SPMT 060204		3007-M2.2x5	80-T07				
ATUM 16.5XD3 SPMT 060204	○	16.5	25	34	127	51	71	56								
ATUM 17XD3 SPMT 060204	●	17	25	34	127	51	71	56								
ATUM 17.5XD3 SPMT 060204	●	17.5	25	34	131	54	75	56								
ATUM 18XD3 SPMT 060204	●	18	25	34	131	54	75	56								
ATUM 18.5XD3 SPMT 060204	○	18.5	25	34	134	57	78	56								
ATUM 19XD3 SPMT 060204	●	19	25	34	134	57	78	56								
ATUM 19.5XD3 SPMT 060204	●	19.5	25	34	139	60	83	56								
ATUM 20XD3 SPMT 060204	●	20	25	34	139	60	83	56								
ATUM 20.5XD3 SPMT 060204	○	20.5	25	34	144	63	86	56								
ATUM 21XD3 SPMT 060204	●	21	25	34	144	63	86	56	SPMT 070204		3008-M2.5x6	80-T08				
ATUM 21.5XD3 SPMT 060204	●	21.5	25	34	145	66	89	56								
ATUM 22XD3 SPMT 070204	●	22	25	34	145	66	89	56								
ATUM 22.5XD3 SPMT 070204	○	22.5	25	34	150	69	94	56								
ATUM 23XD3 SPMT 070204	●	23	25	34	150	69	94	56								
ATUM 23.5XD3 SPMT 070204	●	23.5	25	34	154	72	98	56								
ATUM 24XD3 SPMT 070204	●	24	25	34	154	72	98	56	SPMT 060204		3007-M2.2x5	80-T07				
ATUM 24.5XD3 SPMT 070204	●	24.5	25	34	158	75	102	56								
ATUM 25XD3 SPMT 070204	●	25	25	34	158	75	102	56								
ATUM 13XD4 SPMT 050203	●	13	20	25	120	52	70	50					SPMT 050203		3006-M2x4	80-T06
ATUM 14XD4 SPMT 050203	●	14	20	25	124	56	74	50								
ATUM 15XD4 SPMT 050203	●	15	20	25	128	60	78	50								
ATUM 16XD4 SPMT 060204	●	16	25	34	140	64	84	56	SPMT 060204		3007-M2.2x5	80-T07				
ATUM 17XD4 SPMT 060204	●	17	25	34	144	68	88	56								
ATUM 18XD4 SPMT 060204	●	18	25	34	149	72	93	56								
ATUM 19XD4 SPMT 060204	●	19	25	34	153	76	97	56								
ATUM 20XD4 SPMT 060204	●	20	25	34	159	80	103	56								
ATUM 21XD4 SPMT 060204	●	21	25	34	163	84	107	56								
ATUM 22XD4 SPMT 070204	●	22	25	34	167	88	111	56	SPMT 070204		3008-M2.5x6	80-T08				
ATUM 23XD4 SPMT 070204	●	23	25	34	173	92	117	56								
ATUM 24XD4 SPMT 070204	●	24	25	34	178	96	122	56								
ATUM 25XD4 SPMT 070204	●	25	25	34	183	100	127	56								

R: Sağ/Right L: Sol/Left ● Stokta/In Stock ○ Stokta Yok/Non Stock Item

Sipariş Örneği/Ordering Example : 1 ad./pcs. ATUM 13xD3 SPMT 050203
Takma Uçlu Matkap Kullanım Kılavuzu : S 143 / User's Guide For U-Drills : P 143



Delme Derinliği = 2xÇap
Drilling Depth = 2xDiameter

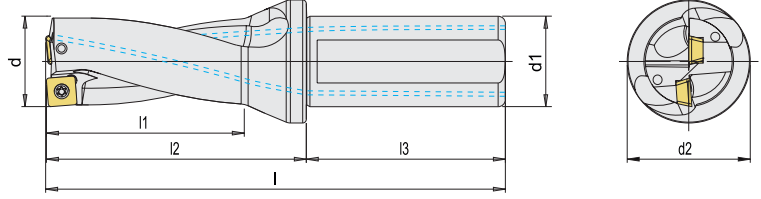

Takım Kodu Ordering Code	Stok Stock	Takım Ölçüleri (mm) Dimension (mm)							Kesici Uç Insert	Yedek Parçaları Spare Parts		
		d	d ₁	d ₂	l	l ₁	l ₂	l ₃		Sıkma Vidası Clamp Screw	Tork Anahtar Torx Key	
									SPMG-SPKX-SPGT			
ATUM 12.5XD2 SP.. 050204	○	12.5	20	25	94	26	44	50	SP.. 050204			
ATUM 13XD2 SP.. 050204	○	13	20	25	94	26	44	50				
ATUM 13.5XD2 SP.. 050204	○	13.5	20	25	96	28	46	50				
ATUM 14XD2 SP.. 050204	●	14	20	25	96	28	46	50				
ATUM 14.5XD2 SP.. 050204	○	14.5	20	25	99	30	49	50				
ATUM 15XD2 SP.. 050204	○	15	20	25	99	30	49	50				
ATUM 15.5XD2 SP.. 060204	○	15.5	20	25	102	32	52	50	SP.. 060204			
ATUM 16XD2 SP.. 060204	○	16	25	34	108	32	52	56				
ATUM 16.5XD2 SP.. 060204	●	16.5	25	34	110	34	54	56				
ATUM 17XD2 SP.. 060204	○	17	25	34	110	34	54	56				
ATUM 17.5XD2 SP.. 060204	○	17.5	25	34	113	36	57	56				
ATUM 18XD2 SP.. 060204	○	18	25	34	113	36	57	56				
ATUM 18.5D2 SP.. 060204	●	18.5	25	34	115	38	59	56				
ATUM 19XD2 SP.. 060204	●	19	25	34	115	38	59	56				
ATUM 19.5XD2 SP.. 060204	○	19.5	25	34	119	40	63	56				
ATUM 20XD2 SP.. 060204	●	20	25	34	119	40	63	56				
ATUM 20.5XD2 SP.. 060204	○	20.5	25	34	121	42	65	56	SP.. 07T308			
ATUM 21XD2 SP.. 060204	●	21	25	34	121	42	65	56				
ATUM 21.5XD2 SP.. 060204	○	21.5	25	34	123	44	67	56				
ATUM 22XD2 SP.. 07T308	●	22	25	34	123	44	67	56				
ATUM 22.5XD2 SP.. 07T308	○	22.5	25	34	127	46	71	56				
ATUM 23XD2 SP.. 07T308	●	23	25	34	127	46	71	56				
ATUM 23.5XD2 SP.. 07T308	●	23.5	25	34	130	48	74	56				
ATUM 24XD2 SP.. 07T308	●	24	25	34	130	48	74	56				
ATUM 24.5XD2 SP.. 07T308	○	24.5	25	34	133	48	77	56				
ATUM 25XD2 SP.. 07T308	●	25	25	34	133	50	77	56				
ATUM 25.5XD2 SP.. 07T308	○	25.5	25	34	135	52	79	56				
ATUM 26XD2 SP.. 07T308	●	26	25	34	135	52	79	56				

R: Sağ/Right L: Sol/Left ● Stokta/In Stock ○ Stokta Yok/Non Stock Item

Sipariş Örneği/Ordering Example : 1 ad./pcs. ATUM 12.5xD2 SP.. 050204
Takma Uçlu Matkap Kullanım Kılavuzu : S 143 / User's Guide For U-Drills : P 143

TAKMA UÇLU MATKAPLAR

U-DRILL SYSTEM



Delme Derinliği = 2xÇap
Drilling Depth = 2xDiameter

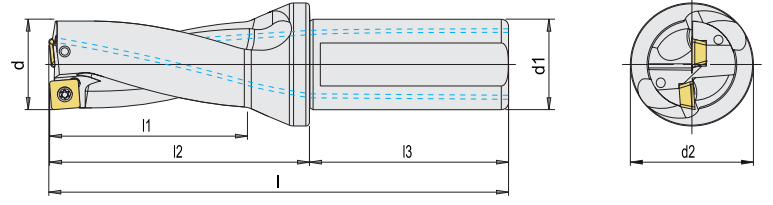

Takım Kodu Ordering Code	Stok Stock	Takım Ölçüleri (mm) Dimension (mm)							Kesici Uç Insert SPMG-SPKX-SPGT	Yedek Parçaları Spare Parts	
		d	d ₁	d ₂	l	l ₁	l ₂	l ₃		Sıkma Vidası Clamp Screw	Tork Anahtar Torx Key
ATUM 26.5XD2 SP.. 07T308	○	26.5	25	34	137	54	81	56	SP.. 07T308	3208-M2.5x6.4	80-T08
ATUM 27XD2 SP.. 07T308	●	27	25	34	137	54	81	56			
ATUM 27.5XD2 SP.. 07T308	○	27.5	25	34	140	56	84	56			
ATUM 28XD2 SP.. 090408	●	28	25	34	140	56	84	56			
ATUM 28.5XD2 SP.. 090408	○	28.5	25	34	142	58	86	56	SP.. 090408	1015-M3.5x9	80-T15
ATUM 29XD2 SP.. 090408	○	29	25	34	142	58	86	56			
ATUM 29.5XD2 SP.. 090408	○	29.5	25	34	151	60	91	56			
ATUM 30XD2 SP.. 090408	●	30	32	44	151	60	91	60			
ATUM 31XD2 SP.. 090408	○	31	32	44	154	62	94	60			
ATUM 32XD2 SP.. 090408	●	32	32	44	156	64	96	60			
ATUM 33XD2 SP.. 090408	○	33	32	44	159	66	99	60			
ATUM 34XD2 SP.. 110408	●	34	32	44	161	68	101	60			
ATUM 35XD2 SP.. 110408	○	35	32	44	164	70	104	60			
ATUM 36XD2 SP.. 110408	●	36	32	44	167	72	107	60			
ATUM 37XD2 SP.. 110408	○	37	32	44	170	74	110	60	SP.. 110408	1515-M4x11	80-T15
ATUM 38XD2 SP.. 110408	○	38	32	44	173	76	113	60			
ATUM 39XD2 SP.. 110408	○	39	32	44	175	78	115	60			
ATUM 40XD2 SP.. 110408	○	40	32	44	178	80	118	60			
ATUM 41XD2 SP.. 110408	○	41	32	44	181	82	121	60			
ATUM 42XD2 SP.. 140512	○	42	32	44	183	84	123	60			
ATUM 43XD2 SP.. 140512	○	43	32	44	186	86	126	60	SP.. 140512	1020-M5x11	80-T20
ATUM 44XD2 SP.. 140512	○	44	32	44	188	88	128	60			
ATUM 45XD2 SP.. 140512	○	45	40	54	202	90	132	70			
ATUM 46XD2 SP.. 140512	○	46	40	54	205	92	135	70			
ATUM 47XD2 SP.. 140512	○	47	40	54	207	94	137	70			
ATUM 48XD2 SP.. 140512	○	48	40	54	210	96	140	70			
ATUM 49XD2 SP.. 140512	○	49	40	54	212	98	142	70			
ATUM 50XD2 SP.. 140512	○	50	40	54	215	100	145	70			

R: Sağ/Right L: Sol/Left ● Stokta/In Stock ○ Stokta Yok/Non Stock Item

Sipariş Örneği/Ordering Example : 1 ad./pcs. ATUM 26.5xD2 SP.. 07T308
Takma Uçlu Matkap Kullanım Kılavuzu : S 143 / User's Guide For U-Drills : P 143



Delme Derinliği = 3xÇap
Drilling Depth = 3xDiameter

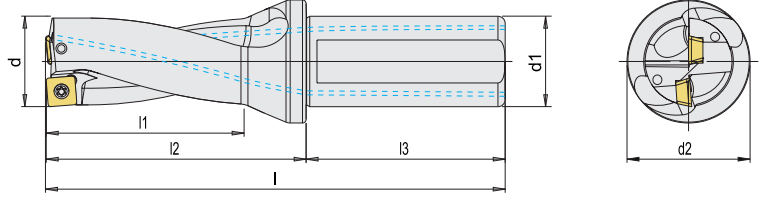

Takım Kodu Ordering Code	Stok Stock	Takım Ölçüleri (mm) Dimension (mm)							Kesici Uç Insert	Yedek Parçaları Spare Parts	
		d	d ₁	d ₂	l	l ₁	l ₂	l ₃		Sıkma Vidası Clamp Screw	Tork Anahtar Torx Key
									SPMG-SPKX-SPGT		
ATUM 12.5XD3 SP.. 050204	●	12.5	20	25	107	39	57	50	SP.. 050204	3006-M2x4	80-T06
ATUM 13XD3 SP.. 050204	●	13	20	25	107	39	57	50			
ATUM 13.5XD3 SP.. 050204	●	13.5	20	25	110	42	60	50			
ATUM 14XD3 SP.. 050204	●	14	20	25	110	42	60	50			
ATUM 14.5XD3 SP.. 050204	●	14.5	20	25	113	45	63	50			
ATUM 15XD3 SP.. 050204	●	15	20	25	113	45	63	50			
ATUM 15.5XD3 SP.. 060204	○	15.5	20	25	118	48	68	50	SP.. 060204	3007-M2.2x5	80-T07
ATUM 16XD3 SP.. 060204	●	16	25	34	124	48	68	56			
ATUM 16.5XD3 SP.. 060204	●	16.5	25	34	127	51	71	56			
ATUM 17XD3 SP.. 060204	●	17	25	34	127	51	71	56			
ATUM 17.5XD3 SP.. 060204	●	17.5	25	34	131	54	75	56			
ATUM 18XD3 SP.. 060204	●	18	25	34	131	54	75	56			
ATUM 18.5XD3 SP.. 060204	●	18.5	25	34	134	57	78	56			
ATUM 19XD3 SP.. 060204	●	19	25	34	134	57	78	56			
ATUM 19.5XD3 SP.. 060204	●	19.5	25	34	139	60	83	56			
ATUM 20XD3 SP.. 060204	●	20	25	34	139	60	83	56			
ATUM 20.5XD3 SP.. 060204	●	20.5	25	34	142	63	86	56			
ATUM 21XD3 SP.. 060204	●	21	25	34	142	63	86	56			
ATUM 21.5XD3 SP.. 060204	○	21.5	25	34	145	66	89	56			
ATUM 22XD3 SP.. 07T308	●	22	25	34	145	66	89	56	SP.. 07T308	3208-M2.5x6.4	80-T08
ATUM 22.5XD3 SP.. 07T308	○	22.5	25	34	150	69	94	56			
ATUM 23XD3 SP.. 07T308	●	23	25	34	150	69	94	56			
ATUM 23.5XD3 SP.. 07T308	●	23.5	25	34	154	72	98	56			
ATUM 24XD3 SP.. 07T308	○	24	25	34	154	72	98	56			
ATUM 24.5XD3 SP.. 07T308	●	24.5	25	34	158	75	102	56			
ATUM 25XD3 SP.. 07T308	●	25	25	34	158	75	102	56			
ATUM 25.5XD3 SP.. 07T308	●	25.5	25	34	161	78	105	56			
ATUM 26XD3 SP.. 07T308	●	26	25	34	161	78	105	56			
ATUM 26.5XD3 SP.. 07T308	●	26.5	25	34	164	81	108	56			
ATUM 27XD3 SP.. 07T308	●	27	25	34	164	81	108	56			
ATUM 27.5XD3 SP.. 07T308	●	27.5	25	34	168	84	112	56			

R: Sağ/Right L: Sol/Left ● Stokta/In Stock ○ Stokta Yok/Non Stock Item

Sipariş Örneği/Ordering Example : 1 ad./pcs. ATUM 12.5xD3 SP.. 050204
Takma Uçlu Matkap Kullanım Kılavuzu : S 143 / User's Guide For U-Drills : P 143

TAKMA UÇLU MATKAPLAR

U-DRILL SYSTEM



Delme Derinliği = 3xÇap
Drilling Depth = 3xDiameter

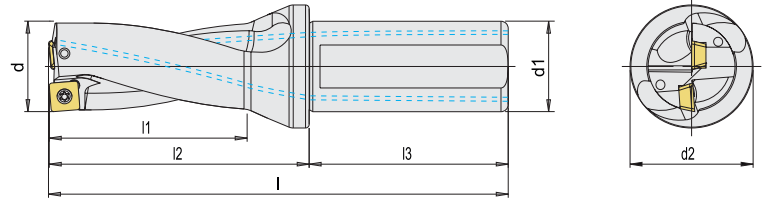

Takım Kodu Ordering Code	Stok Stock	Takım Ölçüleri (mm) Dimension (mm)							Kesici Uç Insert SPMG-SPKX-SPGT	Yedek Parçaları Spare Parts	
		d	d ₁	d ₂	l	l ₁	l ₂	l ₃		Sıkma Vidası Clamp Screw	Tork Anahtar Torx Key
ATUM 28XD3 SP.. 090408	●	28	25	34	168	84	112	56	SP.. 090408	1015-M3.5x9	80-T15
ATUM 28.5XD3 SP.. 090408	○	28.5	25	34	171	87	115	56			
ATUM 29XD3 SP.. 090408	●	29	25	34	171	87	115	56			
ATUM 29.5XD3 SP.. 090408	○	29.5	25	34	177	90	121	56			
ATUM 30XD3 SP.. 090408	●	30	32	44	181	90	121	60			
ATUM 31XD3 SP.. 090408	●	31	32	44	185	93	125	60			
ATUM 32XD3 SP.. 090408	●	32	32	44	188	96	128	60			
ATUM 33XD3 SP.. 090408	●	33	32	44	192	99	132	60	SP.. 110408	1515-M4x11	80-T15
ATUM 34XD3 SP.. 110408	●	34	32	44	195	102	135	60			
ATUM 35XD3 SP.. 110408	●	35	32	44	199	105	139	60			
ATUM 36XD3 SP.. 110408	●	36	32	44	203	108	143	60			
ATUM 37XD3 SP.. 110408	●	37	32	44	207	111	147	60			
ATUM 38XD3 SP.. 110408	●	38	32	44	211	114	151	60			
ATUM 39XD3 SP.. 110408	●	39	32	44	214	117	154	60			
ATUM 40XD3 SP.. 110408	●	40	32	44	218	120	158	60	SP.. 140512	1020-M5x11	80-T20
ATUM 41XD3 SP.. 110408	●	41	32	44	222	123	162	60			
ATUM 42XD3 SP.. 140512	●	42	32	44	225	126	165	60			
ATUM 43XD3 SP.. 140512	●	43	32	44	229	129	169	60			
ATUM 44XD3 SP.. 140512	○	44	32	44	232	132	172	60			
ATUM 45XD3 SP.. 140512	○	45	40	54	247	135	177	70			
ATUM 46XD3 SP.. 140512	●	46	40	54	251	138	181	70			
ATUM 47XD3 SP.. 140512	○	47	40	54	254	141	184	70			
ATUM 48XD3 SP.. 140512	○	48	40	54	258	144	188	70			
ATUM 49XD3 SP.. 140512	●	49	40	54	261	147	191	70			
ATUM 50XD3 SP.. 140512	○	50	40	54	265	150	195	70			
ATUM 51XD3 SP.. 140512	○	51	40	60	268	153	198	70			
ATUM 52XD3 SP.. 140512	○	52	40	60	271	156	201	70			
ATUM 53XD3 SP.. 140512	○	53	40	60	274	159	204	70			
ATUM 54XD3 SP.. 140512	○	54	40	60	277	162	207	70			
ATUM 55XD3 SP.. 140512	○	55	40	60	280	165	210	70			
ATUM 56XD3 SP.. 140512	○	56	40	60	283	168	213	70			
ATUM 57XD3 SP.. 140512	○	57	40	60	286	171	216	70			
ATUM 58XD3 SP.. 140512	○	58	40	60	289	174	219	70			
ATUM 59XD3 SP.. 140512	○	59	40	60	292	177	222	70			
ATUM 60XD3 SP.. 140512	○	60	40	60	295	180	225	70			

R: Sağ/Right L: Sol/Left ● Stokta/In Stock ○ Stokta Yok/Non Stock Item

Sipariş Örneği/Ordering Example : 1 ad./pcs. ATUM 28xD3 SP.. 090408
Takma Uçlu Matkap Kullanım Kılavuzu : S 143 / User's Guide For U-Drills : P 143



Delme Derinliği = 4xÇap
Drilling Depth = 4xDiameter

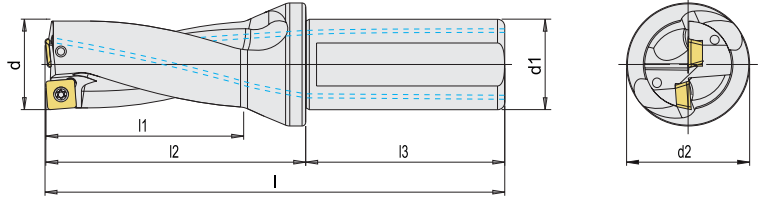

Takım Kodu Ordering Code	Stok Stock	Takım Ölçüleri (mm) Dimension (mm)							Kesici Uç Insert	Yedek Parçaları Spare Parts	
		d	d ₁	d ₂	l	l ₁	l ₂	l ₃		Sıkma Vidası Clamp Screw	Tork Anahtar Torx Key
									SPMG-SPKX-SPGT		
ATUM 13XD4 SP.. 050204	○	13	20	25	120	52	70	50	SP.. 050204	3006-M2x4	80-T06
ATUM 14XD4 SP.. 050204	●	14	20	25	124	56	74	50			
ATUM 15XD4 SP.. 050204	○	15	20	25	128	60	78	50			
ATUM 16XD4 SP.. 060204	○	16	25	34	140	64	84	56	SP.. 060204	3007-M2.2x5	80-T07
ATUM 17XD4 SP.. 060204	○	17	25	34	144	68	88	56			
ATUM 18XD4 SP.. 060204	●	18	25	34	149	72	93	56			
ATUM 19XD4 SP.. 060204	●	19	25	34	153	76	97	56			
ATUM 20XD4 SP.. 060204	●	20	25	34	159	80	103	56			
ATUM 21XD4 SP.. 060204	○	21	25	34	163	84	107	56			
ATUM 22XD4 SP.. 07T308	●	22	25	34	167	88	111	56	SP.. 07T308	3208-M2.5x6.4	80-T08
ATUM 23XD4 SP.. 07T308	●	23	25	34	173	92	117	56			
ATUM 24XD4 SP.. 07T308	●	24	25	34	178	96	122	56			
ATUM 25XD4 SP.. 07T308	○	25	25	34	183	100	127	56			
ATUM 26XD4 SP.. 07T308	●	26	25	34	187	104	131	56			
ATUM 27XD4 SP.. 07T308	○	27	25	34	191	108	135	56			
ATUM 28XD4 SP.. 090408	○	28	25	34	196	112	140	56	SP.. 090408	1015-M3.5x9	80-T15
ATUM 29XD4 SP.. 090408	○	29	25	34	200	116	144	56			
ATUM 30XD4 SP.. 090408	●	30	32	44	211	120	151	60			
ATUM 31XD4 SP.. 090408	○	31	32	44	216	124	156	60			
ATUM 32XD4 SP.. 090408	●	32	32	44	220	128	160	60			
ATUM 33XD4 SP.. 090408	○	33	32	44	225	132	165	60			
ATUM 34XD4 SP.. 110408	○	34	32	44	229	136	169	60	SP.. 110408	1515-M4x11	80-T15
ATUM 35XD4 SP.. 110408	○	35	32	44	234	140	174	60			
ATUM 36XD4 SP.. 110408	○	36	32	44	239	144	179	60			
ATUM 37XD4 SP.. 110408	●	37	32	44	244	148	184	60			
ATUM 38XD4 SP.. 110408	○	38	32	44	249	152	189	60			
ATUM 39XD4 SP.. 110408	○	39	32	44	253	156	193	60			
ATUM 40XD4 SP.. 110408	○	40	32	44	258	160	198	60	SP.. 140512	1020-M5x11	80-T20
ATUM 41XD4 SP.. 110408	○	41	32	44	263	164	203	60			
ATUM 42XD4 SP.. 140512	○	42	32	44	267	168	207	60			
ATUM 43XD4 SP.. 140512	○	43	32	44	272	172	212	60			
ATUM 44XD4 SP.. 140512	○	44	32	44	276	170	216	60			

R: Sağ/Right L: Sol/Left ● Stokta/In Stock ○ Stokta Yok/Non Stock Item

Sipariş Örneği/Ordering Example : 1 ad./pcs. ATUM 13xD4 SP.. 050204
Takma Uçlu Matkap Kullanım Kılavuzu : S 143 / User's Guide For U-Drills : P 143

Konuşulan Kalite

The Spoken Quality



 **AKKO**[®]

KESİCİ UÇ BAĞLAMA SİSTEMLERİ

CONNECTION SYSTEMS FOR CUTTING INSERTS

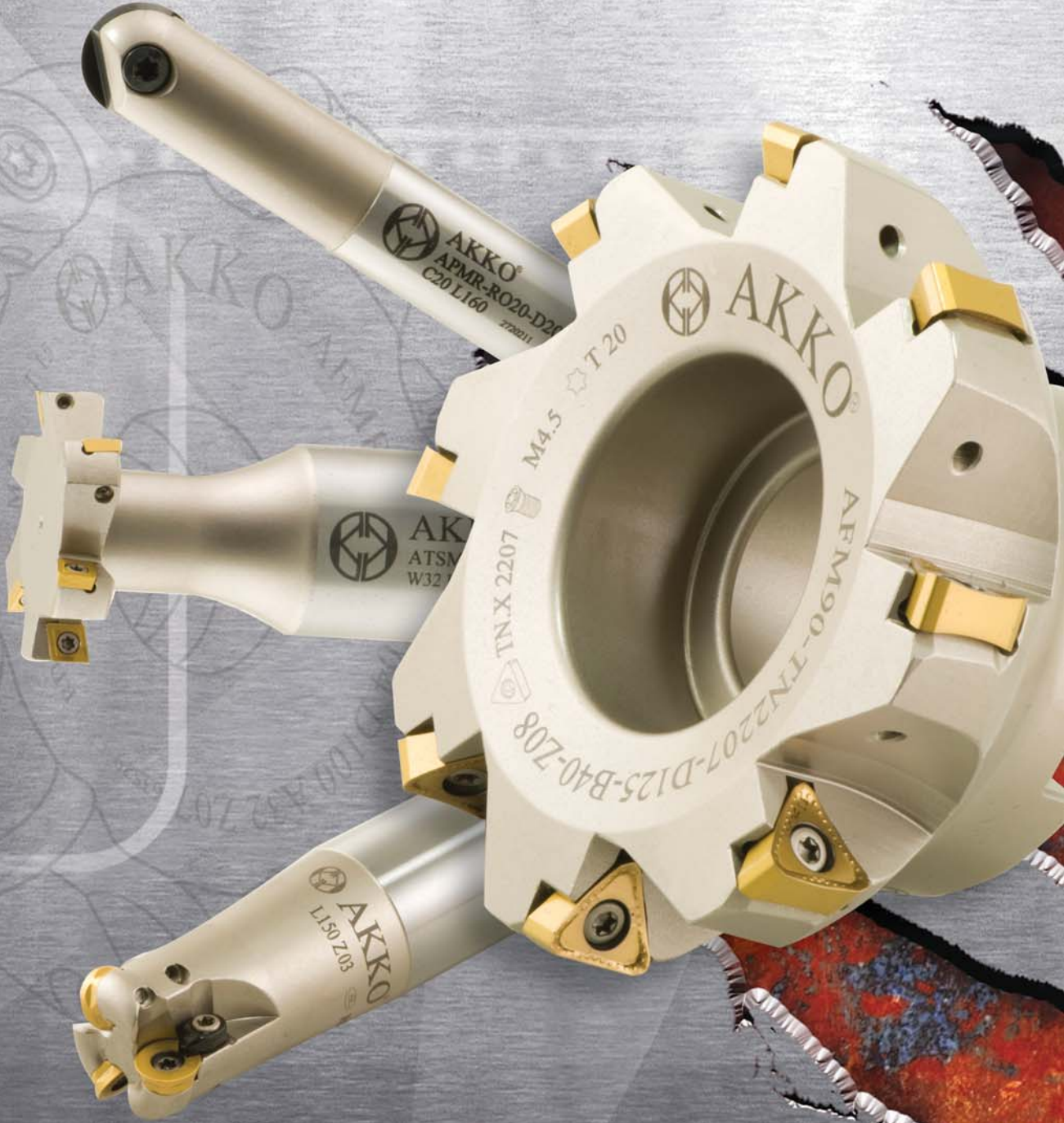

FREZELEME TAKIMLARI
MILLING TOOLS

AKKO **A** **EM** **90** - **A** **P** **10**

1 2 3 4 5 6

D12 - **W16** - **L100** - **Z01** - **H**

7 8 9 10 11

2 Kesiş Stili / Cutter Style

FM: Yüzey Frezeleme Takımları - Face Milling Tools
 EM: Alın ve Yüzey Parmak Frezeleri - End Face Milling Tools
 CM: Pah Kırma Parmak Frezeleri - Chamfering End Milling Tools
 HM: Helis Parmak Frezeleri - Helix End Milling Tools
 TSM: T Kanal Frezeleri - T Slot Milling Tools
 HFM: Yüksek İlerleme Frezeleme Takımları - High Feed Milling Tools
 PMR: Küresel Uçlu Parmak Frezeleri - Ball Nose End Milling Tools

3 Freze Yanaşma Açısı / Lead Angle

90° - 75° - 60° - 45°
 20° - 15° - 11° - 5° - 0°

6 Kesme Kenar Uzunluğu / Cutting Edge Length

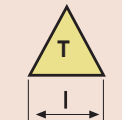
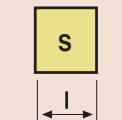
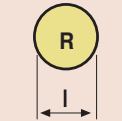
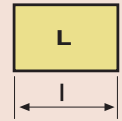
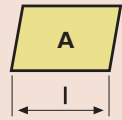

4 Uç Tipi / Insert Shape

C	D	E	K
L	R	S	T
V	W	A	B
H	M	O	P

5 Serbest Uç Açısı / Clearance angle of Insert

A	B	C
D	E	F
G	N	P

7 Takım Çapı / Tool Diameter

8 Montaj Formu ve Çapı / Assembly Form and Diameter

A, B, C, D,: ISO'ya göre montaj formu / Assembly form to ISO
 C: Silindirik Şaft / Cylindrical Shank
 W: Weldon

9 Takım Boyu / Tool Length

10 Etkili Diş Adedi / Number of Effective Tooth

11 İçten Soğutmalı / With Coolant Hole

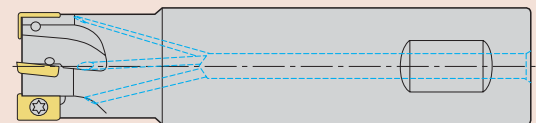



PARMAK FREZELER

PARMAK FREZELER
END MILLING TOOLS

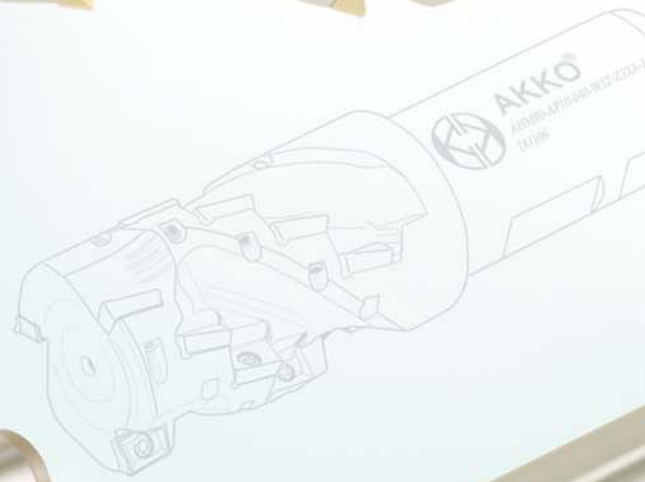

S-SİSTEM YÜZEY PARMAK FREZELER

S-SYSTEM END MILLS

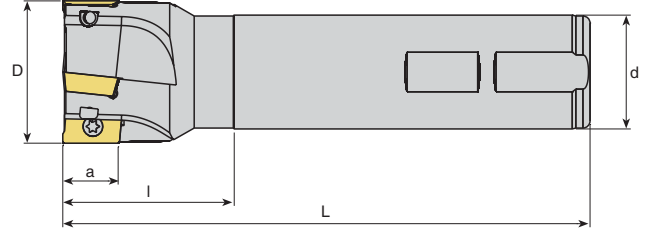

Takım Kodu Ordering Code	Stok Stock	Kater Ölçüleri (mm) Dimension (mm)						Kesici Uç Insert	Yedek Parçaları Spare Parts	
		D	Z	d	L	l	a		Sıkma Vidası Clamp Screw	Tork Anahtar Torx Key
AEM90-AP10-D12-W16-L100-Z01-H	●	12	1	16	100	30	10	AP.. 1003..	3008-M2.5x6	80-T08
AEM90-AP10-D14-W16-L100-Z01-H	●	14	1	16	100	30	10			
AEM90-AP10-D16-W16-L100-Z02-H	●	16	2	16	100	30	10			
AEM90-AP10-D18-W16-L100-Z02-H	●	18	2	16	100	40	10			
AEM90-AP10-D20-W20-L100-Z03-H	●	20	3	20	100	30	10			
AEM90-AP10-D22-W20-L100-Z03-H	●	22	3	20	100	30	10			
AEM90-AP10-D25-W25-L100-Z03-H	●	25	3	25	100	30	10			
AEM90-AP10-D12-W16-L150-Z01	●	12	1	16	150	38	10			
AEM90-AP10-D14-W16-L150-Z01	●	14	1	16	150	38	10			
AEM90-AP10-D16-W16-L150-Z02	●	16	2	16	150	50	10			
AEM90-AP10-D16-C16-L150-Z02-H	●	16	2	16	150	50	10			
AEM90-AP10-D18-W16-L150-Z02	●	18	2	16	150	40	10			
AEM90-AP10-D20-W20-L150-Z03	●	20	3	20	150	50	10			
AEM90-AP10-D20-C20-L150-Z03-H	●	20	3	20	150	50	10			
AEM90-AP10-D21-W20-L150-Z03	●	21	3	20	150	50	10			
AEM90-AP10-D22-W20-L150-Z03	●	22	3	20	150	50	10			
AEM90-AP10-D24-W20-L150-Z03	●	24	3	20	150	50	10			
AEM90-AP10-D25-W25-L150-Z03	●	25	3	25	150	50	10			
AEM90-AP10-D32-W25-L150-Z04	●	32	4	25	150	50	10			
AEM90-AP10-D32-W32-L150-Z04	●	32	4	32	150	50	10			
AEM90-AP10-D40-W32-L150-Z05	●	40	5	32	150	50	10			
AEM90-AP10-D16-C16-L200-Z02	●	16	2	16	200	100	10			
AEM90-AP10-D20-C20-L200-Z02	●	20	2	20	200	100	10			
AEM90-AP10-D25-C25-L200-Z02	●	25	2	25	200	100	10			
AEM90-AP10-D25-C25-L200-Z03	●	25	3	25	200	100	10			
AEM90-AP10-D25-C25-L250-Z02	●	25	2	25	250	100	10			
AEM90-AP11-D16-W16-L150-Z02	●	16	2	16	150	50	11	AP.. 11T3..	3008-M2.5x6	80-T08
AEM90-AP11-D16-C16-L150-Z02	●	16	2	16	150	50	11			
AEM90-AP11-D17-C16-L150-Z02	●	17	2	16	150	50	11			
AEM90-AP11-D20-W20-L150-Z03	●	20	3	20	150	50	11			
AEM90-AP11-D20-C20-L150-Z03	●	20	3	20	150	50	11			
AEM90-AP11-D21-W20-L150-Z03	●	21	3	20	150	50	11			
AEM90-AP11-D21-W20-L150-Z03-H	●	21	3	20	150	50	11			
AEM90-AP11-D21-C20-L150-Z03	●	21	3	20	150	50	11			
AEM90-AP11-D25-W25-L150-Z03	●	25	3	25	150	50	11			
AEM90-AP11-D25-W25-L150-Z03-H	●	25	3	25	150	50	11			
AEM90-AP11-D25-C25-L150-Z03	●	25	3	25	150	50	11			
AEM90-AP11-D26-C25-L150-Z03	●	26	3	25	150	50	11			
AEM90-AP11-D32-W25-L150-Z04	●	32	4	25	150	50	11			
AEM90-AP11-D32-W32-L150-Z03-H	●	32	3	32	150	50	11			
AEM90-AP11-D32-W32-L150-Z04	●	32	4	32	150	50	11			
AEM90-AP11-D16-C16-L200-Z02	●	16	2	16	200	100	11			
AEM90-AP11-D17-C16-L200-Z02	●	17	2	16	200	100	11			
AEM90-AP11-D20-C20-L200-Z03	●	20	3	20	200	100	11			
AEM90-AP11-D21-C20-L200-Z03	●	21	3	20	200	100	11			

R: Sağ/Right L: Sol/Left ● Stokta/In Stock ○ Stokta Yok/Non Stock Item

Sipariş Örneği/Ordering Example : 1 ad./pcs. AEM90-AP10-D12-W16-L100-Z01-H

Kesme Hesabı : S-144 / Cutting Calculation: P-144

S-SİSTEM YÜZEY PARMAK FREZELER

S-SYSTEM END MILLS



90°

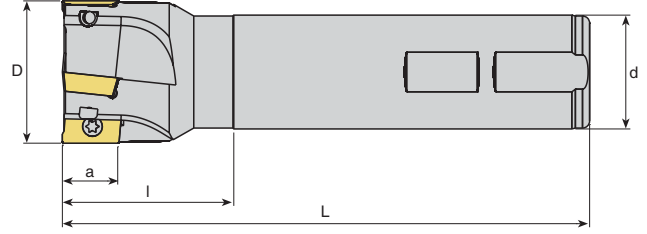

Takım Kodu Ordering Code	Stok Stock	Kater Ölçüleri (mm) Dimension (mm)						Kesici Uç Insert	Yedek Parçaları Spare Parts	
		D	Z	d	L	l	a		Sıkma Vidası Clamp Screw	Tork Anahtar Torx Key
AEM90-AP1204-D20-C20-L150-Z02	●	20	2	20	150	30	12	AP.. 1204..	1510-M3.5x9	80-T10
AEM90-AP1204-D21-C20-L150-Z02	●	21	2	20	150	30	12			
AEM90-AP1204-D25-C25-L150-Z03	●	25	3	25	150	40	12			
AEM90-AP1204-D32-C25-L150-Z03	●	32	3	25	150	35	12			
AEM90-AP1204-D21-C20-L200-Z02	●	21	2	20	200	30	12			
AEM90-AP1204-D26-C25-L250-Z02	●	26	2	25	250	35	12	AP.. 1604..	1515-M4x9	80-T15
AEM90-AP16-D25-W25-L100-Z02-H	●	25	2	25	100	35	16			
AEM90-AP16-D28-W25-L100-Z03-H	●	28	3	25	100	40	16			
AEM90-AP16-D30-W25-L110-Z03-H	●	30	3	25	110	40	16			
AEM90-AP16-D32-W32-L110-Z03-H	●	32	3	32	110	40	16			
AEM90-AP16-D36-W32-L110-Z03-H	●	36	3	32	110	40	16			
AEM90-AP16-D40-W32-L110-Z04-H	●	40	4	32	110	40	16			
AEM90-AP16-D25-W25-L150-Z02	●	25	2	25	150	50	16			
AEM90-AP16-D28-W25-L150-Z03	●	28	3	25	150	50	16			
AEM90-AP16-D30-W25-L150-Z03	●	30	3	25	150	50	16			
AEM90-AP16-D32-W25-L150-Z03	●	32	3	25	150	50	16			
AEM90-AP16-D32-W32-L150-Z03	●	32	3	32	150	50	16			
AEM90-AP16-D32-C32-L150-Z03	●	32	3	32	150	50	16			
AEM90-AP16-D35-W32-L150-Z03	●	35	3	32	150	50	16			
AEM90-AP16-D36-W32-L150-Z03	●	36	3	32	150	50	16			
AEM90-AP16-D40-W32-L150-Z04	●	40	4	32	150	50	16			
AEM90-AP16-D40-C32-L150-Z04	●	40	4	32	150	50	16			
AEM90-AP16-D25-C25-L250-Z02	●	25	2	25	250	100	16			
AEM90-AP16-D32-C32-L250-Z02	●	32	2	32	250	100	16			
AEM90-AP16-D32-C32-L250-Z03	●	32	3	32	250	100	16			
AEM90-AP16-D40-C32-L250-Z02	●	40	2	32	250	50	16			
AEM90-AP16-D40-C32-L250-Z04	●	40	4	32	250	50	16			
AEM90-AP1705-D25-C25-L120-Z02	●	25	2	25	120	40	16	AP.. 1705..	1515-M4x9	1515-M4x11
AEM90-AP1705-D32-C25-L150-Z03	●	32	3	25	150	45	16			
AEM90-AP1705-D26-C25-L200-Z02	●	26	2	25	200	40	16			
AEM90-AP1705-D26-C25-L250-Z02	●	26	2	25	250	40	16			
AEM90-AP1705-D33-C32-L300-Z02	●	33	2	32	300	40	16			

R: Sağ/Right L: Sol/Left ● Stokta/In Stock ○ Stokta Yok/Non Stock Item

Sipariş Örneği/Ordering Example : 1 ad./pcs. AEM90-AP16-D25-W25-L100-Z02-H
Kesme Hesabı : S-144 / Cutting Calculation: P-144



S-SİSTEM YÜZEY PARMAK FREZELER

S-SYSTEM END MILLS

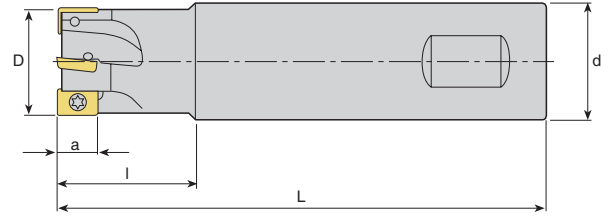

Takım Kodu Ordering Code	Stok Stock	Kater Ölçüleri (mm) Dimension (mm)						Kesici Uç Insert	Yedek Parçaları Spare Parts	
		D	Z	d	L	l	a		Sıkma Vidası Clamp Screw	Tork Anahtar Torx Key
AEM90-XC13-D20-W20-L150-Z02	●	20	2	20	150	50	13			
AEM90-XC13-D25-W25-L150-Z03	●	25	3	25	150	50	13			
AEM90-XC13-D32-W32-L150-Z04	●	32	4	32	150	50	13			

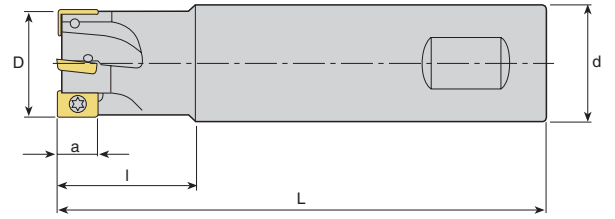

Takım Kodu Ordering Code	Stok Stock	Kater Ölçüleri (mm) Dimension (mm)						Kesici Uç Insert	Yedek Parçaları Spare Parts	
		D	Z	d	L	l	a		Sıkma Vidası Clamp Screw	Tork Anahtar Torx Key
AEM90-X006-D10-C12-L120-Z02	●	10	2	12	120	50	5			
AEM90-X006-D12-C12-L120-Z02	●	12	2	12	120	25	5			
AEM90-X009-D16-W16-L150-Z02	●	16	2	16	150	50	8			
AEM90-X009-D20-W20-L150-Z03	●	20	3	20	150	50	8			
AEM90-X012-D20-W20-L150-Z02	●	20	2	20	150	50	11			
AEM90-X012-D22-W20-L150-Z02	●	22	2	20	150	50	11			
AEM90-X012-D25-W25-L150-Z03	●	25	3	25	150	50	11			
AEM90-X012-D32-W32-L150-Z03	●	32	3	32	150	50	11			

R: Sağ/Right L: Sol/Left ● Stokta/In Stock ○ Stokta Yok/Non Stock Item

Sipariş Örneği/Ordering Example : 1 ad./pcs. AEM90-X012-D20-W20-L150-Z02
Kesme Hesabı : S-144 / Cutting Calculation: P-144

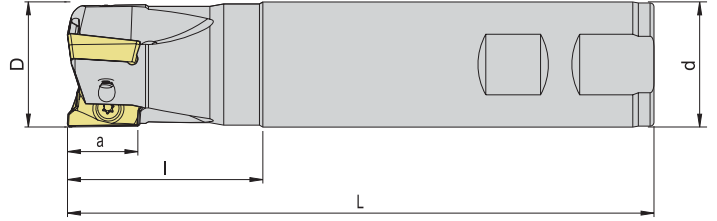

Takım Kodu Ordering Code	Stok Stock	Kater Ölçüleri (mm) Dimension (mm)						Kesici Uç Insert	Yedek Parçaları Spare Parts	
		D	Z	d	L	l	a		Sıkma Vidası Clamp Screw	Tork Anahtar Torx Key
AEM90-RT07-D10-W10-L120-Z02	●	10	2	10	120	30	7	RT 0702	3006-M2x4	80-T06
AEM90-RT07-D12-W12-L120-Z02	●	12	2	12	120	30	7			
AEM90-RT07-D12-C12-L120-Z02	●	12	2	12	120	30	7			
AEM90-RT07-D14-W12-L120-Z02	●	14	2	12	120	30	7			
AEM90-RT10-D16-W16-L120-Z02-H	●	16	2	16	120	30	10	RT 1003	3008-M2.5x6	80-T08
AEM90-RT10-D18-W16-L120-Z02-H	●	18	2	16	120	30	10			
AEM90-RT10-D20-W20-L120-Z03-H	●	20	3	20	120	30	10			
AEM90-RT10-D22-W20-L120-Z03-H	●	22	3	20	120	30	10			
AEM90-RT10-D25-W25-L120-Z04-H	●	25	4	25	120	40	10			
AEM90-RT10-D32-W32-L120-Z05-H	●	32	5	32	120	50	10			
AEM90-RT10-D16-W16-L150-Z02	●	16	2	16	150	50	10			
AEM90-RT10-D20-W20-L150-Z03	●	20	3	20	150	50	10			
AEM90-RT10-D25-W25-L150-Z04	●	25	4	25	150	50	10			
AEM90-RT10-D32-W32-L150-Z05	●	32	5	32	150	50	10			
AEM90-RT10-D17-W16-L160-Z02	●	17	2	16	160	30	10			
AEM90-RT10-D16-C16-L200-Z02	●	16	2	16	200	100	10			
AEM90-RT10-D20-C19-L200-Z03	●	20	3	19	200	100	10			
AEM90-RT10-D20-C20-L200-Z03	●	20	3	20	200	100	10			
AEM90-RT10-D21-W20-L200-Z03	●	21	3	20	200	30	10			
AEM90-RT10-D25-C25-L200-Z04	●	25	4	25	200	100	10			
AEM90-RT10-D32-C32-L200-Z05	●	32	5	32	200	100	10			
AEM90-RT13-D32-C32-L250-Z04	●	32	4	32	250	50	13	RT 1304	1008-M3x9	
AEM90-RT16-D25-W25-L120-Z02-H	●	25	2	25	120	40	16	RT 1606	1515-M4x11	80-T15
AEM90-RT16-D32-W32-L120-Z03-H	●	32	3	32	120	50	16			
AEM90-RT16-D40-W32-L120-Z04-H	●	40	4	32	120	50	16			
AEM90-RT16-D25-W25-L150-Z02	●	25	2	25	150	50	16			
AEM90-RT16-D32-W32-L150-Z03	●	32	3	32	150	50	16			
AEM90-RT16-D40-W32-L150-Z04	●	40	4	32	150	50	16			
AEM90-RT16-D25-C25-L200-Z02	●	25	2	25	200	100	16			
AEM90-RT16-D32-C32-L200-Z03	●	32	3	32	200	100	16			
AEM90-RT16-D40-C32-L200-Z04	●	40	4	32	200	100	16			
AEM90-RT16-D32-C32-L250-Z03	●	32	3	32	250	100	16			
AEM90-RT16-D32-C32-L270-Z03	●	32	3	32	270	100	16			



R: Sağ/Right L: Sol/Left ● Stokta/In Stock ○ Stokta Yok/Non Stock Item

Sipariş Örneği/Ordering Example : 1 ad./pcs. AEM90-RT07-D10-W10-L120-Z02
Kesme Hesabı : S-144 / Cutting Calculation: P-144

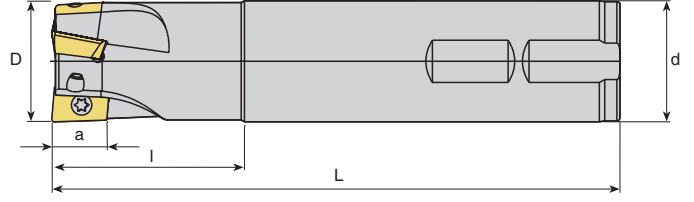

S-SİSTEM YÜZEY PARMAK FREZELER

S-SYSTEM END MILLS

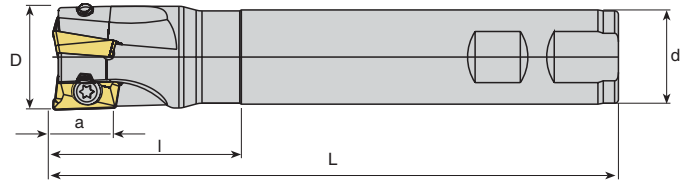

Takım Kodu Ordering Code	Stok Stock	Kater Ölçüleri (mm) Dimension (mm)						Kesici Uç Insert	Yedek Parçaları Spare Parts				
		D	Z	d	L	l	a		Sıkma Vidası Clamp Screw	Tork Anahtar Torx Key			
AEM90-AD1505-D25-W25-L150-Z02	●	25	2	25	150	50	15						
AEM90-AD1505-D30-W25-L150-Z03	●	30	3	25	150	50	15				AD.. 1505..	1515-M4x9	80-T15
AEM90-AD1505-D32-W32-L150-Z03	●	32	3	32	150	50	15						



Takım Kodu Ordering Code	Stok Stock	Kater Ölçüleri (mm) Dimension (mm)						Kesici Uç Insert	Yedek Parçaları Spare Parts	
		D	Z	d	L	l	a		Sıkma Vidası Clamp Screw	Tork Anahtar Torx Key
AEM90-R390.11-D16-W16-L100-Z02-H	●	16	2	16	100	30	11			
AEM90-R390.11-D20-W20-L100-Z03-H	●	20	3	20	100	30	11			
AEM90-R390.11-D25-W25-L100-Z03-H	●	25	3	25	100	35	11			
AEM90-R390.11-D16-W16-L150-Z02	●	16	2	16	150	50	11			
AEM90-R390.11-D16-W16-L150-Z02-H	●	16	2	16	150	50	11			
AEM90-R390.11-D20-W20-L150-Z03	●	20	3	20	150	50	11			
AEM90-R390.11-D20-W20-L150-Z03-H	●	20	3	20	150	50	11			
AEM90-R390.11-D25-W25-L150-Z03	●	25	3	25	150	50	11			
AEM90-R390.11-D25-W25-L150-Z03-H	●	25	3	25	150	50	11			
AEM90-R390.17-D25-W25-L150-Z02	●	25	2	25	150	50	17			
AEM90-R390.17-D25-W25-L150-Z02-H	●	25	2	25	150	50	17			
AEM90-R390.17-D30-W25-L150-Z03	●	30	3	25	150	50	17			
AEM90-R390.17-D30-W25-L150-Z03-H	●	30	3	25	150	50	17			

R: Sağ/Right L: Sol/Left ● Stokta/In Stock ○ Stokta Yok/Non Stock Item

Sipariş Örneği/Ordering Example : 1 ad./pcs. AEM90-R390.11-D16-W16-L100-Z02
Kesme Hesabı : S-144 / Cutting Calculation: P-144

S-SİSTEM YÜZEY PARMAK FREZELER

S-SYSTEM END MILLS

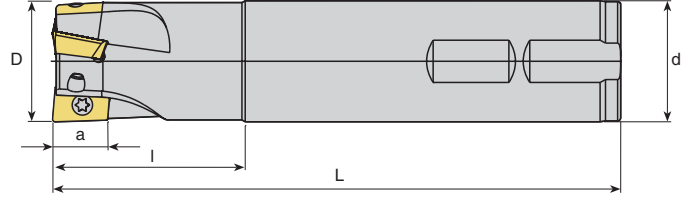

Takım Kodu Ordering Code	Stok Stock	Kater Ölçüleri (mm) Dimension (mm)						Kesici Uç Insert	Yedek Parçaları Spare Parts	
		D	Z	d	L	l	a		Sıkma Vidası Clamp Screw	Tork Anahtar Torx Key
AEM90-AX0602-D10-C10-L120-Z02	●	10	2	10	120	20	5.7	AX.T 0602	3006-M1.8x4	80-T06
AEM90-AX0602-D12-C12-L120-Z02	●	12	2	12	120	20	5.7			
AEM90-AX0903-D16-C16-L120-Z02	●	16	2	16	120	30	8.8	AX.T 0903	3008-M2.5x6	80-T08
AEM90-AX0903-D17-C16-L120-Z02	●	17	2	16	120	25	8.8			
AEM90-AX0903-D20-C20-L120-Z03	●	20	3	20	120	30	8.8			
AEM90-AX0903-D21-C20-L120-Z03	●	21	3	20	120	25	8.8			
AEM90-AX0903-D25-C25-L150-Z03	●	25	3	25	150	30	8.8			
AEM90-AX0903-D26-C25-L150-Z03	●	26	3	25	150	30	8.8			
AEM90-AX0903-D16-C16-L180-Z02	●	16	2	16	180	30	8.8			
AEM90-AX0903-D17-C16-L180-Z02	●	17	2	16	180	25	8.8			
AEM90-AX0903-D20-C20-L200-Z02	●	20	2	20	200	30	8.8			
AEM90-AX0903-D21-C20-L200-Z02	●	21	2	20	200	25	8.8			
AEM90-AX0903-D25-C25-L250-Z02	●	25	2	25	250	40	8.8			

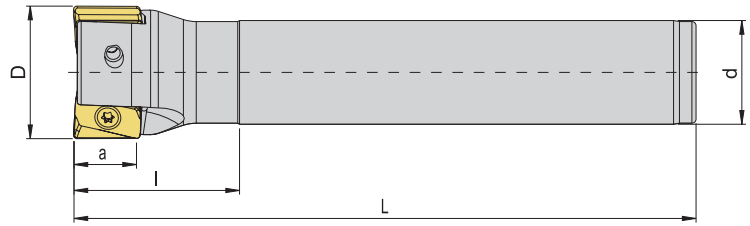

Takım Kodu Ordering Code	Stok Stock	Kater Ölçüleri (mm) Dimension (mm)						Kesici Uç Insert	Yedek Parçaları Spare Parts	
		D	Z	d	L	l	a		Sıkma Vidası Clamp Screw	Tork Anahtar Torx Key
AEM90-AN1607-D32-C25-L150-Z02	●	32	2	25	150	50	15	AN.X 1607	1515-M4x11	80-T15
AEM90-AN1607-D40-C32-L150-Z03	●	40	3	32	150	50	15			

R: Sağ/Right L: Sol/Left ● Stokta/In Stock ○ Stokta Yok/Non Stock Item

Sipariş Örneği/Ordering Example : 1 ad./pcs. AEM90-AN1607-D32-C25-L150-Z02
Kesme Hesabı : S-144 / Cutting Calculation: P-144

S-SİSTEM YÜZEY ve KOPYA PARMAK FREZELER

S-SYSTEM END MILLS

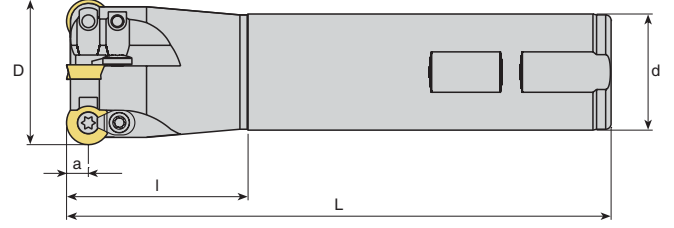

Takım Kodu Ordering Code	Stok Stock	Kater Ölçüleri (mm) Dimension (mm)						Kesici Uç Insert	Yedek Parçaları Spare Parts			
		D	Z	d	L	l	a		Sıkma Vidası Clamp Screw	Baskı Parçası Wedge Clamp	Baskı Vidası Screw	Tork Anahtar Torx Key
AEMR-RD08T2-D16-W16-L150-Z02	●	16	2	16	150	60	4	RD.. 08T2..	3008-M2.5x6	-	-	80-T08
AEMR-RD08T2-D20-W20-L150-Z02	●	20	2	20	150	60	4					
AEMR-RD0803-D16-C16-L150-Z02	●	16	2	16	150	60	4	RD.. 0803..	1008-M3x9	-	-	80-T08
AEMR-RD0803-D16-C20-L200-Z02	●	16	2	20	200	60	4					
AEMRC-RD1003-D20-W20-L150-Z02	●	20	2	20	150	60	5	RD.. 1003..	1015-M3.5x9	ACK-15	1015-M3.5x9	80-T15
AEMRC-RD1003-D25-W25-L150-Z02	●	25	2	25	150	60	5					
AEMRC-RD1003-D32-W32-L150-Z03	●	32	3	32	150	60	5					
AEMRC-RD1003-D40-W32-L150-Z04	●	40	4	32	150	50	5					
AEMRC-RD1003-D20-C20-L160-Z02	●	20	2	20	160	70	5					
AEMRC-RD1003-D25-C25-L160-Z02	●	25	2	25	160	70	5					
AEMRC-RD1003-D25-W25-L200-Z02	●	25	2	25	200	100	5					
AEMRC-RD1003-D25-C25-L200-Z02	●	25	2	25	200	100	5					
AEMRC-RD1003-D20-C20-L250-Z02	●	20	2	20	250	150	5					
AEMRC-RD1003-D25-C25-L250-Z02	●	25	2	25	250	150	5					
AEMRC-RD1003-D32-C32-L250-Z02	●	32	2	32	250	150	5					
AEMRC-RD1003-D40-C32-L250-Z02	●	40	2	32	250	50	5					
AEMRC-RD10T3-D20-W20-L150-Z02	●	20	2	20	150	60	5	RD.. 10T3..	1015-M3.5x9	ACK-15	1015-M3.5x9	80-T15
AEMRC-RD10T3-D25-W25-L150-Z02	●	25	2	25	150	60	5					
AEMRC-RD10T3-D32-W32-L150-Z03	●	32	3	32	150	60	5					
AEMRC-RD12T3-D25-W25-L150-Z02	●	25	2	25	150	60	6	RD.. 12T3..	1015-M3.5x9	ACK-15	1015-M3.5x9	80-T15
AEMRC-RD12T3-D32-W32-L150-Z03	●	32	3	32	150	60	6					
AEMRC-RD12T3-D40-W32-L150-Z04	●	40	4	32	150	50	6					
AEMRC-RD12T3-D25-W25-L200-Z02	●	25	2	25	200	100	6					
AEMRC-RD12T3-D25-C25-L250-Z02	●	25	2	25	250	150	6					
AEMRC-RD12T3-D32-C32-L250-Z02	●	32	2	32	250	150	6					
AEMRC-RD12T3-D40-C32-L250-Z02	●	40	2	32	250	50	6	RD.. 1204..	1015-M4.5x11	ACK-05	1515-M4x11	80-T15
AEMRC-RD12T3-D25-C25-L300-Z02	●	25	2	25	300	150	6					
AEMRC-RD1204-D32-C32-L160-Z03	●	32	3	32	160	70	6	RD.. 1604..	1015-M4.5x11	ACK-05	1515-M4x11	80-T15
AEMRC-RD1604-D40-W32-L150-Z02	●	40	2	32	150	50	8					

R: Sağ/Right L: Sol/Left ● Stokta/In Stock ○ Stokta Yok/Non Stock Item

Sipariş Örneği/Ordering Example : 1 ad./pcs. AEMR-RD0803-D16-C16-L150-Z02
Kesme Hesabı : S-144 / Cutting Calculation: P-144

S-SİSTEM MODÜLER PARMAK FREZELER

S-SYSTEM MODULAR END MILLS (SCREW TYPE TOOLS)

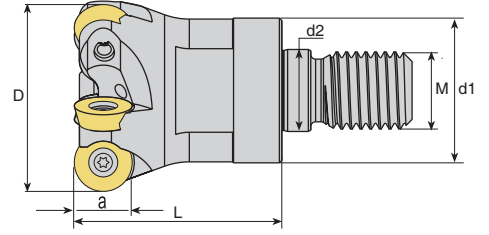

Takım Kodu Ordering Code	Stok Stock	Kater Ölçüleri (mm) Dimension (mm)							Kesici Uç Insert	Yedek Parçaları Spare Parts	
		D	Z	d ₁	M	L	d ₂	a		Sıkma Vidası Clamp Screw	Tork Anahtar Torx Key
AEMR-RD0702-D15-M08-L23-Z02-H	●	15	2	13	M08	23	8.5	3.5	RD.. 0702..	3008-M2.5x6	80-T08
AEMR-RD0702-D16-M08-L23-Z02-H	●	16	2	13	M08	23	8.5	3.5			
AEMR-RD0702-D20-M10-L30-Z04-H	●	20	4	18	M10	30	10.5	3.5			
AEMR-RD0702-D25-M12-L35-Z05-H	●	25	5	21	M12	35	17	3.5			
AEMR-RD0702-D30-M16-L42-Z05-H	●	30	5	29	M16	42	17	3.5			
AEMR-RD0702-D32-M16-L43-Z05-H	●	32	5	26	M16	43	17	3.5			
AEMR-RD0702-D35-M16-L42-Z06-H	●	35	6	29	M16	42	17	3.5			
AEMR-RD1003-D20-M10-L30-Z02-H	●	20	2	18	M10	30	10.5	5	RD.. 1003..	1015-M3.5x9	80-T15
AEMR-RD1003-D25-M12-L35-Z03-H	●	25	3	21	M12	35	12.5	5			
AEMR-RD1003-D30-M16-L43-Z04-H	●	30	4	29	M16	43	17	5			
AEMR-RD1003-D32-M16-L43-Z04-H	●	32	4	29	M16	43	17	5			
AEMR-RD1003-D35-M16-L43-Z04-H	●	35	4	29	M16	43	17	5			
AEMR-RD1003-D40-M16-L43-Z05-H	●	40	5	29	M16	43	17	5			
AEMR-RD1003-D42-M16-L43-Z05-H	●	42	5	29	M16	43	17	5			
AEMR-RD12T3-D24-M12-L35-Z02-H	●	24	2	21	M12	35	12.5	6	RD.. 12T3..	1015-M3.5x9	80-T15
AEMR-RD12T3-D25-M12-L35-Z02-H	●	25	2	21	M12	35	12.5	6			
AEMR-RD12T3-D32-M16-L43-Z03-H	●	32	3	29	M16	43	17	6			
AEMR-RD12T3-D35-M16-L43-Z03-H	●	35	3	29	M16	43	17	6			
AEMR-RD12T3-D35-M16-L43-Z04-H	●	35	4	29	M16	43	17	6			
AEMR-RD12T3-D40-M16-L43-Z04-H	●	40	4	29	M16	43	17	6			
AEMR-RD12T3-D42-M16-L43-Z05-H	●	42	5	29	M16	43	17	6			
AEMR-RD1604-D32-M16-L43-Z02-H	●	32	2	29	M16	43	17	8	RD.. 1604..	1015-M4.5X11	
AEMR-RD1604-D40-M16-L43-Z02-H	●	40	2	29	M16	43	17	8			
AEMR-RD1604-D42-M16-L43-Z03-H	●	42	3	29	M16	43	17	8			

R: Sağ/Right L: Sol/Left ● Stokta/In Stock ○ Stokta Yok/Non Stock Item

Sipariş Örneği/Ordering Example : 1 ad./pcs. AEMR-RD0702-D15-M08-L23-Z02-H
Kesme Hesabı : S-144 / Cutting Calculation: P-144



S-SİSTEM MODÜLER PARMAK FREZELER

S-SYSTEM MODULAR END MILLS (SCREW TYPE TOOLS)

90°

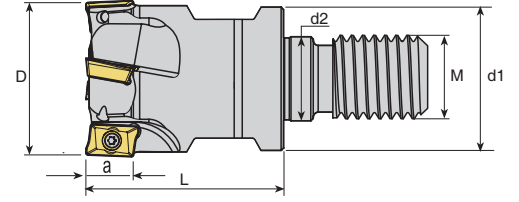

Takım Kodu Ordering Code	Stok Stock	Kater Ölçüleri (mm) Dimension (mm)							Kesici Uç Insert	Yedek Parçaları Spare Parts	
		D	Z	d ₁	M	L	d ₂	a		Sıkma Vidası Clamp Screw	Tork Anahtar Torx Key
AEM90-AP10-D16-M08-L30-Z02-H	●	16	2	14.75	M08	30	8.5	10	AP.. 1003..	3008-M2.5x6	80-T08
AEM90-AP10-D20-M10-L30-Z03-H	●	20	3	18	M10	30	10.5	10			
AEM90-AP10-D25-M12-L35-Z03-H	●	25	3	21	M12	35	12.5	10			
AEM90-AP10-D32-M16-L35-Z04-H	○	32	4	29	M16	35	17	10			
AEM90-AP10-D40-M16-L43-Z05-H	○	40	5	29	M16	43	17	10			
AEM90-AP10-D42-M16-L43-Z05-H	●	42	5	29	M16	43	17	10			
AEM90-AP11-D16-M08-L30-Z02-H	●	16	2	14.75	M08	30	8.5	11	AP.. 11T3..	3008-M2.5x6	80-T08
AEM90-AP11-D20-M10-L30-Z03-H	●	20	3	18	M10	30	10.5	11			
AEM90-AP16-D25-M12-L43-Z02-H	●	25	2	21	M12	43	12.5	16	AP.. 1604..	1515-M4x11	80-T15
AEM90-AP16-D32-M16-L43-Z03-H	●	32	3	29	M16	43	17	16			
AEM90-AP16-D40-M16-L43-Z04-H	●	40	4	29	M16	43	17	16			

90°

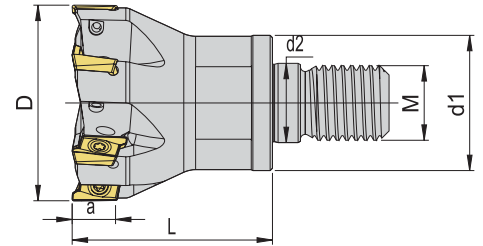

Takım Kodu Ordering Code	Stok Stock	Kater Ölçüleri (mm) Dimension (mm)							Kesici Uç Insert	Yedek Parçaları Spare Parts	
		D	Z	d ₁	M	L	d ₂	a		Sıkma Vidası Clamp Screw	Tork Anahtar Torx Key
AEM90-RT10-D25-M12-L30-Z04-H	●	25	4	21	M12	30	12.5	10	RT 1003..	3008-M2.5x6	80-T08
AEM90-RT10-D32-M16-L43-Z05-H	●	32	5	29	M16	43	17	10			
AEM90-RT10-D42-M16-L43-Z06-H	●	42	6	29	M16	43	17	10			

R: Sağ/Right L: Sol/Left ● Stokta/In Stock ○ Stokta Yok/Non Stock Item

Sipariş Örneği/Ordering Example : 1 ad./pcs. AEM90-AP10-D16-M08-L30-Z02-H
Kesme Hesabı : S-144 / Cutting Calculation: P-144

KÜRE UÇLU PARMAK FREZELER

BALL NOSE END MILLS

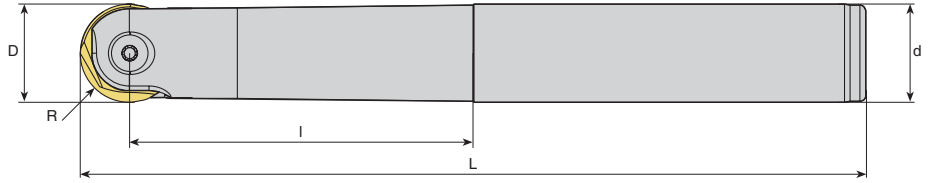

Takım Kodu Ordering Code	Stok Stock	Kater Ölçüleri (mm) Dimension (mm)					Kesici Uç Insert	Yedek Parçaları Spare Parts	
		D	R	d	L	I		Sıkma Vidası Clamp Screw	Anahtar Key
APMR-P3208-D8-C10-L110	●	8	4	10	110	25		1208-M3x7	80-T08
APMR-P3210-D10-C12-L130	●	10	5	12	130	30		1215-M4x0.5x9	80-T15
APMR-P3212-D12-C12-L130	●	12	6	12	130	32		1220-M5x0.5x12	80-T20
APMR-P3216-D16-C16-L175	●	16	8	16	175	60		1220-M5x0.5x15	80-T20
APMR-P3220-D20-C20-L200	●	20	10	20	200	100		1220-M6x0.75x20	AAL-05-4
APMR-P3225-D25-C25-L200	●	25	12.5	25	200	100		1204-M8x0.75x26	
APMR-P3232-D32-C32-L200	●	32	16	32	200	100			



Takım Kodu Ordering Code	Stok Stock	Kater Ölçüleri (mm) Dimension (mm)					Kesici Uç Insert	Yedek Parçaları Spare Parts	
		D	R	d	L	I		Sıkma Vidası Clamp Screw	Tork Anahtar Torx Key
APMR-R012-D12-C12-L120	●	12	6	12	120	35		1215-M4x0.5x9	80-T15
APMR-R012-D12-C16-L160	●	12	6	16	160	50		1215-M5x0.5x12	80-T15
APMR-R016-D16-C16-L160	●	16	8	16	160	45		1215-M5x0.5x15	
APMR-R016-D16-C20-L200	●	16	8	20	200	65			
APMR-R020-D20-C20-L160	●	20	10	20	160	55			
APMR-R020-D20-C25-L220	●	20	10	25	220	80			

R: Sağ/Right L: Sol/Left ● Stokta/In Stock ○ Stokta Yok/Non Stock Item

Sipariş Örneği/Ordering Example : 1 ad./pcs. APMR-R012-D12-C12-L120
Kesme Hesabı : S-144 / Cutting Calculation: P-144

S-SİSTEM HELİS FREZELER

S-SYSTEM HELIX END MILLS

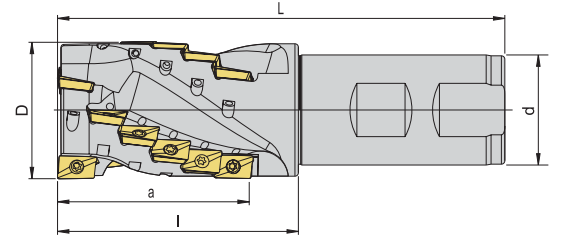

Takım Kodu Ordering Code	Stok Stock	Kater Ölçüleri (mm) Dimension (mm)							Kesici Uç Insert	Yedek Parçaları Spare Parts	
		Z		D	d	a	L	l		Sıkma Vidası Clamp Screw	Tork Anahtar Torx Key
		TOPLAM TOTAL	ETKİLİ EFFECTIVE								
AHM90-AP10-D20-W20-L087-Z06	●	6	2	20	20	28	87	36	AP.. 1003..	3008-M2.5x6	80-T08
AHM90-AP10-D25-W25-L105-Z08	●	8	2	25	25	37	105	47			
AHM90-AP10-D32-W32-L115-Z15	●	15	3	32	32	46	115	54			
AHM90-AP10-D40-W32-L130-Z18-H	●	18	3	40	32	55	130	70			

R: Sağ/Right L: Sol/Left ● Stokta/In Stock ○ Stokta Yok/Non Stock Item

Sipariş Örneği/Ordering Example : 1 ad./pcs. AHM90-AP10-D20-W20-L087-Z06
Kesme Hesabı : S-144 / Cutting Calculation: P-144



S-SİSTEM PAH FREZELER

S-SYSTEM CHAMFERING END MILLS

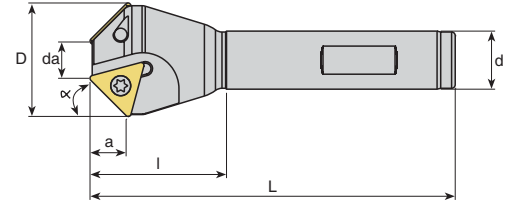

Takım Kodu Ordering Code	Stok Stock	Kater Ölçüleri (mm) Dimension (mm)								Kesici Uç Insert	Yedek Parçaları Spare Parts	
		α	d _a	D	d	L	l	Z	a		Sıkma Vidası Clamp Screw	Tork Anahtar Torx Key
ACM45 -TC09-D7X19-W16-L100-Z02	●	45°	7	19	16	100	25	2	6.3	TCM. 0902..	3007-M2.2x5	80-T07
ACM10 -TC16-D17X20-W16-L90-Z01	●	10°	17	20	16	90	30	1	15.7			
ACM15 -TC16-D17X22-W16-L90-Z01	●	15°	17	22	16	90	30	1	15.4			
ACM17.5 -TC16-D17X24-W16-L90-Z01	●	17.5°	17	24	16	90	30	1	15.2			
ACM20 -TC16-D12X20-W16-L100-Z01	●	20°	12	20	16	100	30	1	15			
ACM20 -TC16-D17X26-W16-L100-Z01	●	20°	17	26	16	100	30	1	15			
ACM22.5 -TC16-D17X28-W16-L100-Z01	●	22.5°	17	28	16	100	30	1	14.7			
ACM25 -TC16-D17X30-W16-L100-Z01	●	25°	17	30	16	100	30	1	14.5			
ACM30 -T C16-D6X20-W16-L100-Z01	●	30°	6	20	16	100	30	1	13.8			
ACM30 -TC16-D20X35-W16-L100-Z02	●	30°	20	35	16	100	35	2	13.8			
ACM30 -TC16-D30X45-W20-L100-Z02	●	30°	30	45	20	100	40	2	13.8			
ACM45 -TC16-D5X23-W16-L100-Z01	●	45°	5	23	16	100	30	1	11.3			
ACM45 -TC16-D10X30-W16-L100-Z02	●	45°	10	30	16	100	35	2	11.3			
ACM45 -TC16-D18X37-W20-L100-Z02	●	45°	18	37	20	100	40	2	11.3			
ACM45 -TC16-D20X40-W20-L100-Z02	●	45°	20	40	20	100	40	2	11.3			
ACM45 -TC16-D30X50-W20-L100-Z02	●	45°	30	50	20	100	40	2	11.3			
										TCM. 16T3..	1015-M3.5x9	80-T15

R: Sağ/Right L: Sol/Left ● Stokta/In Stock ○ Stokta Yok/Non Stock Item

Sipariş Örneği/Ordering Example : 1 ad./pcs. ACM45-TC09-D7X19-W16-L100-Z02
Kesme Hesabı : S-144 / Cutting Calculation: P-144



Konuşulan Kalite

The Spoken Quality



 **AKKO**®



YÜZEY ve KOPYA FREZELER

YÜZEY ve KOPYA FREZELER

FACE and COPY MILLING



YÜZEY FREZELER FACE MILLING

90°

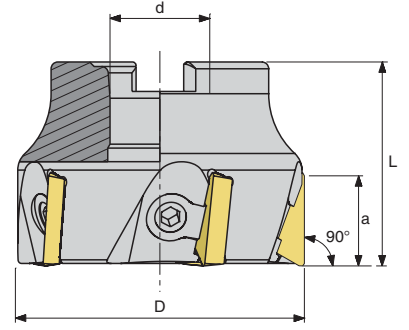

Takım Kodu Ordering Code	Stok Stock	Kater Ölçüleri (mm) Dimension (mm)					Kesici Uç Insert	Yedek Parçaları Spare Parts				
		D	z	d	L	a		Baskı Pabucu Wedge Clamp	Baskı Pabuç Vidası Screw	Altılık Shim	Altılık Vidası Shim Screw	Anahtar Allen Key
AFM90C-TP16-D050 -A22-Z04	●	50	4	22	40	12	TP.. 1603..	ACK-10	AKV-13-M8x1x16			
AFM90C-TP16-D063 -A22-Z06	●	63	6	22	45	12						
AFM90C-TP16-D080 -A27-Z07	●	80	7	27	50	12						
AFM90C-TP16-D100 -A32-Z08	●	100	8	32	50	12						
AFM90C-TP22-D063 -A22-Z05	●	63	5	22	45	18	TP.. 2204..	ACK-11	AKV-14-M8x1x18			AAL-05-4
AFM90C-TP22-D080 -A27-Z06	●	80	6	27	50	18						
AFM90C-TP22-D100 -A32-Z07	●	100	7	32	50	18						
AFM90C-TP22-D125 -B40-Z08	●	125	8	40	63	18						
AFM90C-TP22-D160 -C40-Z09	●	160	9	40	63	18						
AFM90C-TP22-D200 -C60-Z12	●	200	12	60	63	18						
AFM90C-TP22-D250 -C60-Z15	●	250	15	60	63	18						
AFM90C-TP22-D315 -D60-Z18	●	315	18	60	63	18						
AFM90C-TP22-D063 -A22-Z05	○	63	5	22	45	18						
AFM90C-TP22-D080 -A27-Z06	○	80	6	27	50	18						
AFM90C-TP22-D100 -A32-Z07	○	100	7	32	50	18	06192201	06192205				
AFM90C-TP22-D125 -B40-Z08	○	125	8	40	63	18						
AFM90C-TP22-D160 -C40-Z09	○	160	9	40	63	18						
AFM90C-TP22-D200 -C60-Z12	○	200	12	60	63	18						
AFM90C-TP22-D250 -C60-Z15	○	250	15	60	63	18						
AFM90C-TP22-D315 -D60-Z18	○	315	18	60	63	18						

R: Sağ/Right L: Sol/Left ● Stokta/In Stock ○ Stokta Yok/Non Stock Item

Sipariş Örneği/Ordering Example : 1 ad./pcs. AFM90C-TP16-D050-A22-Z04

Kesme Hesabı : S-144 / Cutting Calculation: P-144

Montaj Ölçüleri : S-145 / Mounting Reference : P-145

43°

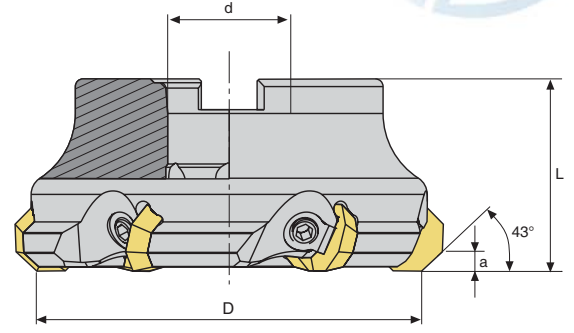

Takım Kodu Ordering Code	Stok Stock	Kater Ölçüleri (mm) Dimension (mm)					Kesici Uç Insert	Yedek Parçaları Spare Parts		
		D	Z	d	L	a		Baskı Pabucu Wedge Clamp	Baskı Vidası Screw	Anahtar Allen Key
AFM43C-OF07-D063-A22-Z04	●	63	4	22	40	5	OF.. 0704..	ACK-11	AKV-15-M8x1x20	AAL-05-4
AFM43C-OF07-D080-A27-Z05	●	80	5	27	50	5				
AFM43C-OF07-D100-A32-Z06	●	100	6	32	50	5				

75°

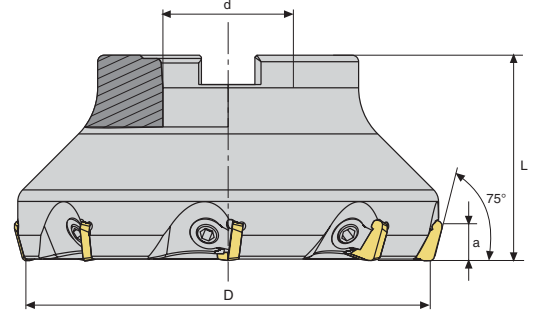

Takım Kodu Ordering Code	Stok Stock	Kater Ölçüleri (mm) Dimension (mm)					Kesici Uç Insert	Yedek Parçaları Spare Parts		
		D	Z	d	L	a		Baskı Pabucu Wedge Clamp	Baskı Vidası Screw	Anahtar Allen Key
AFM75C-SP12-D050-A22-Z04	●	50	4	22	42	8	SPKN 1203..	ACK-10	AKV-13-M8x1x16	AAL-05-4
AFM75C-SP12-D063-A22-Z05	●	63	5	22	40	8				
AFM75C-SP12-D080-A27-Z06	●	80	6	27	50	8				
AFM75C-SP12-D100-A32-Z07	●	100	7	32	50	8				
AFM75C-SP12-D125-B40-Z08	●	125	8	40	63	8				
AFM75C-SP12-D160-C40-Z09	●	160	9	40	63	8				
AFM75C-SP12-D200-C60-Z12	●	200	12	60	63	8				

R: Sağ/Right L: Sol/Left ● Stokta/In Stock ○ Stokta Yok/Non Stock Item

Sipariş Örneği/Ordering Example : 1 ad./pcs. AFM75C-SP12-D050-A22-Z04
Kesme Hesabı : S-144 / Cutting Calculation : P-144
Montaj Ölçüleri : S-145 / Mounting Reference : P-145

YÜZEY FREZELER FACE MILLING

45°

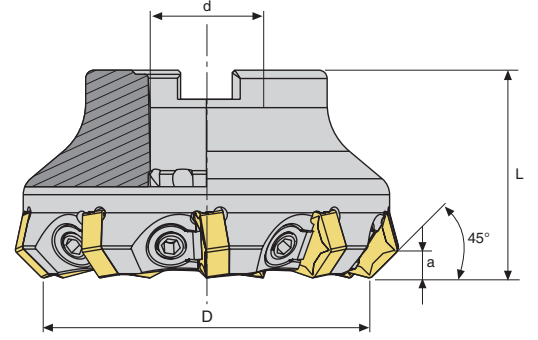

Takım Kodu Ordering Code	Stok Stock	Kater Ölçüleri (mm) Dimension (mm)					Kesici Uç Insert	Yedek Parçaları Spare Parts		
		D	Z	d	L	a		Baskı Pabucu Wedge Clamp	Baskı Vidası Screw	Anahtar Allen Key
AFM45C-HN09-D063-A22-Z07	●	63	7	22	40	4.5				
AFM45C-HN09-D080-A27-Z09	●	80	9	27	50	4.5				
AFM45C-HN09-D100-A32-Z11	●	100	11	32	50	4.5				
AFM45C-HN09-D125-B40-Z13	●	125	13	40	63	4.5				
AFM45C-HN09-D160-C40-Z15	●	160	15	40	63	4.5				
							HN.. 0905..	ACK-11	AKV-14-M8x1x18	AAL-05-4

90°

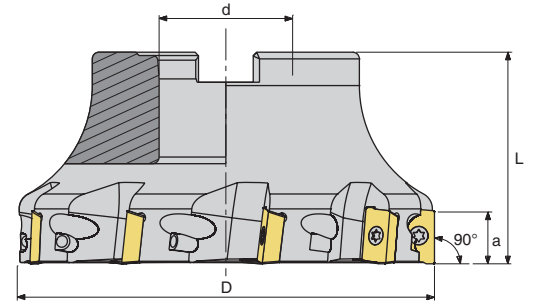

Takım Kodu Ordering Code	Stok Stock	Kater Ölçüleri (mm) Dimension (mm)					Kesici Uç Insert	Yedek Parçaları Spare Parts	
		D	Z	d	L	a		Sıkma Vidası Clamp Screw	Tork Anahtar Torx Key
AFM90-R390.11-D040-A16-Z05-H	●	40	5	16	40	11			
AFM90-R390.11-D050-A22-Z06-H	●	50	6	22	40	11			
AFM90-R390.11-D063-A22-Z07-H	●	63	7	22	40	11			
AFM90-R390.17-D040-A16-Z04-H	●	40	4	16	40	17			
AFM90-R390.17-D050-A22-Z05-H	●	50	5	22	40	17			
AFM90-R390.17-D063-A22-Z06-H	●	63	6	22	40	17			
AFM90-R390.17-D080-A27-Z07-H	●	80	7	27	50	17			
AFM90-R390.17-D100-A32-Z08-H	●	100	8	32	50	17			
AFM90-R390.17-D125-B40-Z09	●	125	9	40	63	17			
							R390.1704..	1015-M3.5x9	80-T15

R: Sağ/Right L: Sol/Left ● Stokta/In Stock ○ Stokta Yok/Non Stock Item

Sipariş Örneği/Ordering Example : 1 ad./pcs. AFM90-R390.11-D040-A16-Z05-H
Kesme Hesabı : S-144 / Cutting Calculation : P-144
Montaj Ölçüleri : S-145 / Mounting Reference : P-145

90°

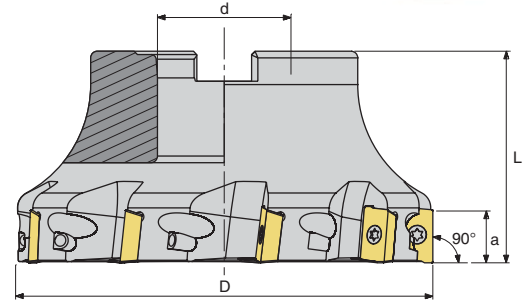

Takım Kodu Ordering Code	Stok Stock	Kater Ölçüleri (mm) Dimension (mm)					Kesici Uç Insert	Yedek Parçaları Spare Parts	
		D	Z	d	L	a		Sıkma Vidası Clamp Screw	Tork Anahtar Torx Key
AFM90-AP10-D040-A16-Z05-H	●	40	5	16	40	10	AP.. 1003..	3008-M2.5x6	80-T08
AFM90-AP10-D050-A22-Z06-H	●	50	6	22	40	10			
AFM90-AP10-D063-A22-Z07-H	●	63	7	22	40	10			
AFM90-AP10-D080-A27-Z08-H	●	80	8	27	50	10			
AFM90-AP10-D100-A32-Z09-H	●	100	9	32	50	10			
AFM90-AP16-D040-A16-Z04-H	●	40	4	16	40	16	AP.. 1604..	1515-M4x11	80-T15
AFM90-AP16-D050-A22-Z05-H	●	50	5	22	40	16			
AFM90-AP16-D063-A22-Z06-H	●	63	6	22	40	16			
AFM90-AP16-D080-A27-Z07-H	●	80	7	27	50	16			
AFM90-AP16-D100-A32-Z08-H	●	100	8	32	50	16			
AFM90-AP16-D125-B40-Z09	●	125	9	40	63	16			
AFM90-AP16-D160-C40-Z10	●	160	10	40	63	16			

90°

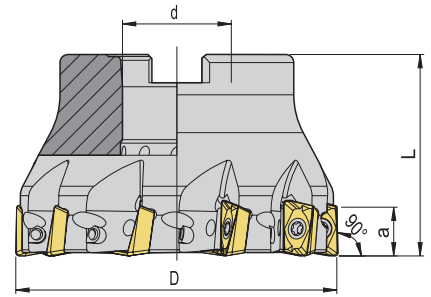





Takım Kodu Ordering Code	Stok Stock	Kater Ölçüleri (mm) Dimension (mm)					Kesici Uç Insert	Yedek Parçaları Spare Parts	
		D	Z	d	L	a		Sıkma Vidası Clamp Screw	Tork Anahtar Torx Key
AFM90-X012-D040-A16-Z05-H	●	40	5	16	40	11	XO.. 1204..	1410-M3.5x9	80-T10
AFM90-X012-D050-A22-Z07-H	●	50	7	22	40	11			
AFM90-X012-D063-A22-Z08-H	●	63	8	22	40	11			
AFM90-X012-D080-A27-Z10-H	●	80	10	27	50	11			

R: Sağ/Right L: Sol/Left ● Stokta/In Stock ○ Stokta Yok/Non Stock Item

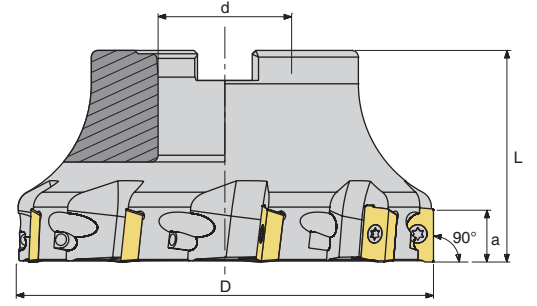

Sipariş Örneği/Ordering Example : 1 ad./pcs. AFM90-X012-D040-A16-Z05-H
Kesme Hesabı : S-144 / Cutting Calculation : P-144
Montaj Ölçüleri : S-145 / Mounting Reference : P-145

YÜZEY FREZELER FACE MILLING

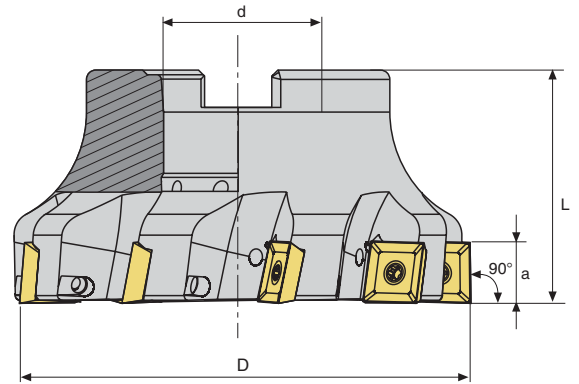

Takım Kodu Ordering Code	Stok Stock	Kater Ölçüleri (mm) Dimension (mm)					Kesici Uç Insert	Yedek Parçaları Spare Parts	
		D	Z	d	L	a		Sıkma Vidası Clamp Screw	Tork Anahtar Torx Key
AFM90-AD1505-D040-A16-Z04-H	●	40	4	16	40	15			
AFM90-AD1505-D050-A22-Z05-H	●	50	5	22	40	15			
AFM90-AD1505-D063-A22-Z06-H	●	63	6	22	40	15			
AFM90-AD1505-D080-A27-Z07-H	●	80	7	27	50	15			
AFM90-AD1505-D100-A32-Z08-H	●	100	8	32	50	15			
AFM90-AD1505-D125-B40-Z09	●	125	9	40	63	15			
							AD.. 1505	1515-M4x11	80-T15

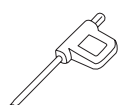

Takım Kodu Ordering Code	Stok Stock	Kater Ölçüleri (mm) Dimension (mm)					Kesici Uç Insert	Yedek Parçaları Spare Parts	
		D	Z	d	L	a		Sıkma Vidası Clamp Screw	Tork Anahtar Torx Key
AFM90-SE12-D050-A22-Z04-H	●	50	4	22	40	12			
AFM90-SE12-D063-A22-Z05-H	●	63	5	22	40	12			
AFM90-SE12-D080-A27-Z07-H	●	80	7	27	50	12			
AFM90-SE12-D100-A32-Z09-H	●	100	9	32	50	12			
AFM90-SE12-D125-B40-Z11	●	125	11	40	63	12			

R: Sağ/Right L: Sol/Left ● Stokta/In Stock ○ Stokta Yok/Non Stock Item

Sipariş Örneği/Ordering Example : 1 ad./pcs. AFM90-SE12-D050-A22-Z04-H
Kesme Hesabı : S-144 / Cutting Calculation: P-144
Montaj Ölçüleri : S-145 / Mounting Reference : P-145

45°

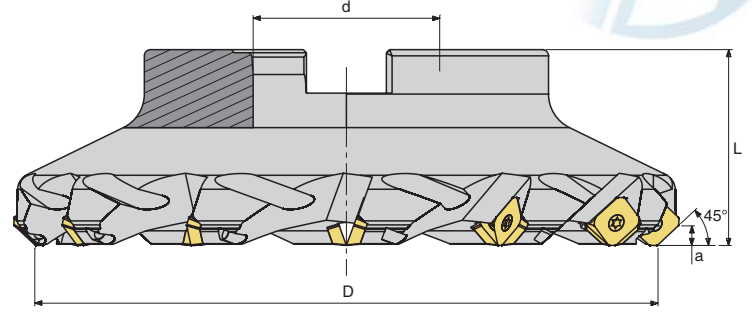

Takım Kodu Ordering Code	Stok Stock	Kater Ölçüleri (mm) Dimension (mm)					Kesici Uç Insert	Yedek Parçaları Spare Parts	
		D	Z	d	L	a		Sıkma Vidası Clamp Screw	Tork Anahtar Torx Key
AFM45-SE12-D050-A22-Z04-H	●	50	4	22	40	6	SE..12T3.. R245-12T3	1015-M3.5x9	80-T15
AFM45-SE12-D063-A22-Z05-H	●	63	5	22	40	6			
AFM45-SE12-D080-A27-Z06-H	●	80	6	27	50	6			
AFM45-SE12-D100-A32-Z07-H	●	100	7	32	50	6			
AFM45-SE12-D125-B40-Z08	●	125	8	40	63	6			
AFM45-SE12-D160-C40-Z10	●	160	10	40	63	6			
AFM45-SE12-D200-C60-Z12	●	200	12	60	63	6			
AFM45-SE14-D063-A22-Z04-H	●	63	4	22	40	7			
AFM45-SE14-D080-A27-Z05-H	●	80	5	27	50	7			
AFM45-SE14-D100-A32-Z05-H	●	100	5	32	50	7			
AFM45-SE14-D125-B40-Z06	●	125	6	40	63	7			
AFM45-SE14-D160-C40-Z10	●	160	10	40	63	7			

43°

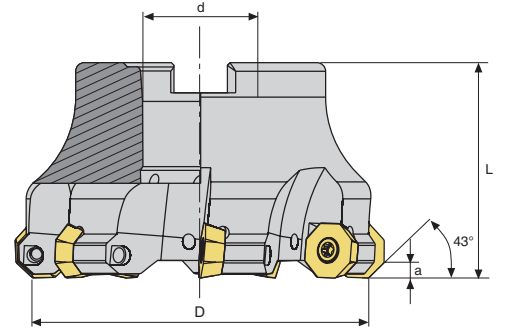

Takım Kodu Ordering Code	Stok Stock	Kater Ölçüleri (mm) Dimension (mm)					Kesici Uç Insert	Yedek Parçaları Spare Parts	
		D	Z	d	L	a		Sıkma Vidası Clamp Screw	Tork Anahtar Torx Key
AFM43-OD0504-D040-A16-Z04-H	●	40	4	16	40	3.5	OD.. 0504..	1015-M3.5x9	80-T15
AFM43-OD0504-D050-A22-Z05-H	●	50	5	22	40	3.5			
AFM43-OD0504-D063-A22-Z06-H	●	63	6	22	40	3.5			
AFM43-OD0504-D080-A27-Z07-H	●	80	7	27	50	3.5			
AFM43-OD0504-D100-A32-Z08-H	●	100	8	32	50	3.5			

R: Sağ/Right L: Sol/Left ● Stokta/In Stock ○ Stokta Yok/Non Stock Item

Sipariş Örneği/Ordering Example : 1 ad./pcs. AFM43-OD0504-D040-A16-Z04-H
Kesme Hesabı : S-144 / Cutting Calculation : P-144
Montaj Ölçüleri : S-145 / Mounting Reference : P-145

YÜZEY FREZELER FACE MILLING

45°

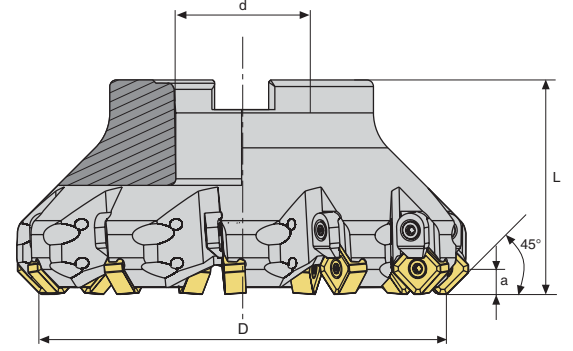

Takım Kodu Ordering Code	Stok Stock	Kater Ölçüleri (mm) Dimension (mm)					Kesici Uç Insert	Yedek Parçaları Spare Parts					
		D	Z	d	L	a		Sıkma Vidası Clamp Screw	Baskı Parçası Wedge Clamp	Baskı Vidası Screw	Tork Anahtar Torx Key		
AFM45C-SN1206-D050-A22-Z05-H	●	50	5	22	40	6	SN.. 1206..			1515-M4x11	ACK-05	1515-M4x11	80-T15
AFM45C-SN1206-D063-A22-Z07-H	●	63	7	22	40	6							
AFM45C-SN1206-D080-A27-Z08-H	●	80	8	27	50	6							
AFM45C-SN1206-D100-A32-Z10-H	●	100	10	32	50	6							
AFM45C-SN1206-D125-B40-Z11	●	125	11	40	63	6							
AFM45C-SN1206-D160-C40-Z12	●	160	12	40	63	6							
AFM45C-SN1206-D200-C60-Z14	●	200	14	60	63	6							

90°

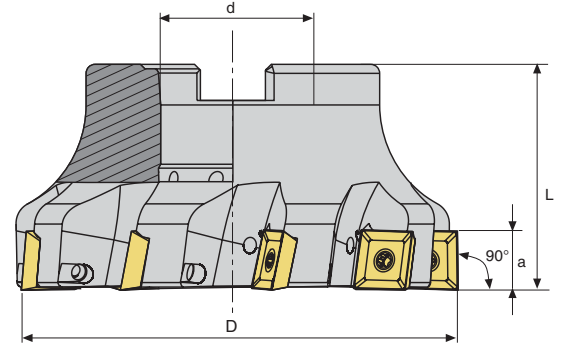

Takım Kodu Ordering Code	Stok Stock	Kater Ölçüleri (mm) Dimension (mm)					Kesici Uç Insert	Yedek Parçaları Spare Parts	
		D	Z	d	L	a		Sıkma Vidası Clamp Screw	Tork Anahtar Torx Key
AFM90-SD09-D050-A22-Z05-H	●	50	5	22	40	9	SD.. 09M4..		80-T15
AFM90-SD09-D063-A22-Z06-H	●	63	6	22	40	9			
AFM90-SD13-D050-A22-Z04-H	●	50	4	22	40	13	SD.. 1305..		80-T20
AFM90-SD13-D063-A22-Z05-H	●	63	5	22	40	13			
AFM90-SD13-D080-A27-Z06-H	●	80	6	27	50	13			
AFM90-SD13-D100-A32-Z07-H	●	100	7	32	50	13			
AFM90-SD13-D125-B40-Z08	●	125	8	40	63	13			
AFM90-SD13-D160-C40-Z10	●	160	10	40	63	13			

R: Sağ/Right L: Sol/Left ● Stokta/In Stock ○ Stokta Yok/Non Stock Item

Sipariş Örneği/Ordering Example : 1 ad./pcs. AFM90-SD09-D050-A22-Z05-H
Kesme Hesabı : S-144 / Cutting Calculation: P-144
Montaj Ölçüleri : S-145 / Mounting Reference : P-145

45°

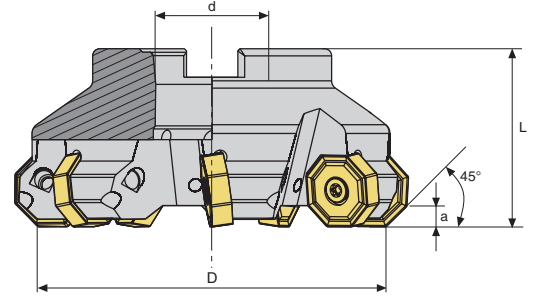

Takım Kodu Ordering Code	Stok Stock	Kater Ölçüleri (mm) Dimension (mm)					Kesici Uç Insert	Yedek Parçaları Spare Parts	
		D	Z	d	L	a		Sıkma Vidası Clamp Screw	Tork Anahtar Torx Key
AFM45-ON08-D063-A22-Z05-H	●	63	5	22	40	4	ON..0806..	1020-M5x11	80-T20
AFM45-ON08-D080-A27-Z06-H	●	80	6	27	50	4			
AFM45-ON08-D100-A32-Z07-H	●	100	7	32	50	4			
AFM45-ON08-D125-B40-Z08	●	125	8	40	63	4			
AFM45-ON08-D160-C40-Z10	●	160	10	40	63	4			
AFM45-ON08-D200-C60-Z12	●	200	12	60	63	4			

90°

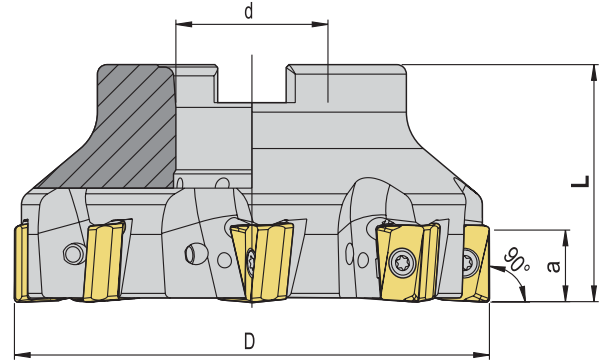

Takım Kodu Ordering Code	Stok Stock	Kater Ölçüleri (mm) Dimension (mm)					Kesici Uç Insert	Yedek Parçaları Spare Parts	
		D	Z	d	L	a		Sıkma Vidası Clamp Screw	Tork Anahtar Torx Key
AFM90-AN1607-D050-A22-Z04-H	●	50	4	22	40	15	AN.X 1607..	1515-M4x11	80-T15
AFM90-AN1607-D063-A22-Z06-H	●	63	6	22	40	15			
AFM90-AN1607-D080-A27-Z07-H	●	80	7	27	50	15			
AFM90-AN1607-D100-A32-Z08-H	●	100	8	32	50	15			

R: Sağ/Right L: Sol/Left ● Stokta/In Stock ○ Stokta Yok/Non Stock Item



Sipariş Örneği/Ordering Example : 1 ad./pcs. AFM90-AN1607-D050-A22-Z04-H
Kesme Hesabı : S-144 / Cutting Calculation: P-144
Montaj Ölçüleri : S-145 / Mounting Reference : P-145

YÜZEY ve KOPYA FREZELER

FACE and COPY MILLING

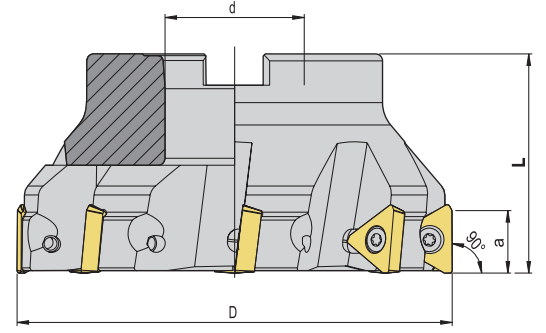

90°

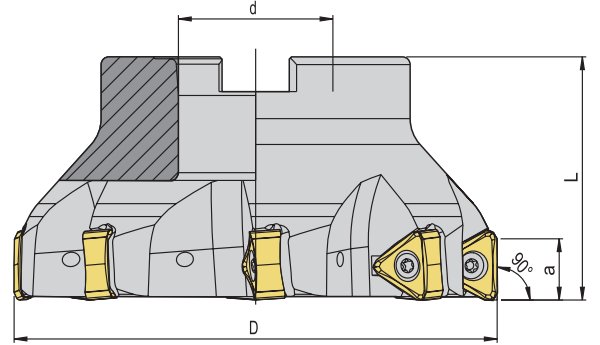

Takım Kodu Ordering Code	Stok Stock	Kater Ölçüleri (mm) Dimension (mm)					Kesici Uç Insert	Yedek Parçaları Spare Parts	
		D	Z	d	L	a		Sıkma Vidası Clamp Screw	Tork Anahtar Torx Key
AFM90-TP2205-D063-A22-Z04	●	63	4	22	40	18	 TPKT 2205..	 1120-M4.5x12	 80-T20
AFM90-TP2205-D080-A27-Z06	●	80	6	27	50	18			
AFM90-TP2205-D100-A32-Z07	●	100	7	32	50	18			
AFM90-TP2205-D125-B40-Z08	●	125	8	40	63	18			
AFM90-TP2205-D160-C40-Z09	●	160	9	40	63	18			

90°

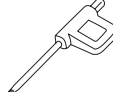

Takım Kodu Ordering Code	Stok Stock	Kater Ölçüleri (mm) Dimension (mm)					Kesici Uç Insert	Yedek Parçaları Spare Parts	
		D	Z	d	L	a		Sıkma Vidası Clamp Screw	Tork Anahtar Torx Key
AFM90-TN2207-D063-A22-Z04-H	●	63	4	22	40	15	 TN.X 2207..	 1120-M4.5x12	 80-T20
AFM90-TN2207-D080-A27-Z05-H	●	80	5	27	50	15			
AFM90-TN2207-D100-B32-Z06	●	100	6	32	50	15			
AFM90-TN2207-D125-B40-Z08	●	125	8	40	63	15			

R: Sağ/Right L: Sol/Left ● Stokta/In Stock ○ Stokta Yok/Non Stock Item

Sipariş Örneği/Ordering Example : 1 ad./pcs. AFM90-TN2207-D063-A22-Z04-H
 Kesme Hesabı : S-144 / Cutting Calculation : P-144
 Montaj Ölçüleri : S-145 / Mounting Reference : P-145

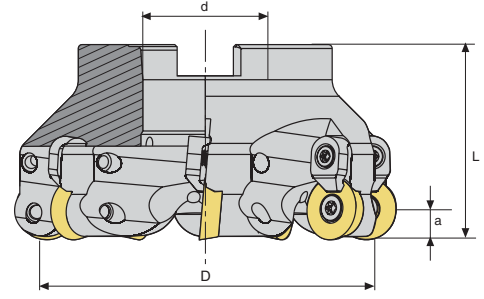

Takım Kodu Ordering Code	Stok Stock	Kater Ölçüleri (mm) Dimension (mm)					Kesici Uç Insert	Yedek Parçaları Spare Parts			
		D	Z	d	L	a		Sıkma Vidası Clamp Screw	Baskı Parçası Wedge Clamp	Baskı Vidası Screw	Tork Anahtar Torx Key
AFMRC-RD1003-D040-A16-Z04-H	●	40	4	16	40	5	RD.. 1003..				
AFMRC-RD1003-D050-A22-Z05-H	●	50	5	22	50	5					
AFMRC-RD1003-D063-A22-Z06-H	●	63	6	22	50	5					
AFMRC-RD1003-D080-A27-Z07-H	●	80	7	27	50	5					
AFMRC-RD1003-D100-A32-Z08-H	●	100	8	32	50	5					
AFMRC-RD12T3-D040-A16-Z04-H	●	40	4	16	40	6	RD.. 12T3..	1015-M3.5x9	ACK-15	1015-M3.5x9	80-T15
AFMRC-RD12T3-D050-A22-Z05-H	●	50	5	22	50	6					
AFMRC-RD12T3-D063-A22-Z06-H	●	63	6	22	50	6					
AFMRC-RD12T3-D080-A27-Z07-H	●	80	7	27	50	6					
AFMRC-RD12T3-D100-A32-Z08-H	●	100	8	32	50	6					
AFMRC-RD12T3-D125-B40-Z09	●	125	9	40	63	6					
AFMRC-RD1204-D40-A16-Z04-H	●	40	4	16	40	6	RD.. 1204..				
AFMRC-RD1204-D050-A22-Z05-H	●	50	5	22	50	6					
AFMRC-RD1204-D052-A22-Z05-H	●	52	5	22	50	6					
AFMRC-RD1204-D063-A22-Z06-H	●	63	6	22	50	6					
AFMRC-RD1204-D080-A27-Z07-H	●	80	7	27	50	6					
AFMRC-RD1204-D100-A32-Z08-H	●	100	8	32	50	6					
AFMRC-RD1604-D052-A22-Z04-H	●	52	4	22	50	8	RD.. 1604..	1015-M4.5x11	ACK-05	1515-M4x11	
AFMRC-RD1604-D063-A22-Z05-H	●	63	5	22	50	8					
AFMRC-RD1604-D080-A27-Z06-H	●	80	6	27	50	8					
AFMRC-RD1604-D100-A32-Z07-H	●	100	7	32	50	8					

R: Sağ/Right L: Sol/Left ● Stokta/In Stock ○ Stokta Yok/Non Stock Item



Sipariş Örneği/Ordering Example : 1 ad./pcs. AFMRC-RD1003-D040-A16-Z04-H

Kesme Hesabı : S-144 / Cutting Calculation: P-144
Montaj Ölçüleri : S-145 / Mounting Reference : P-145

HIZLI İLERLEMELİ TAKIMLAR

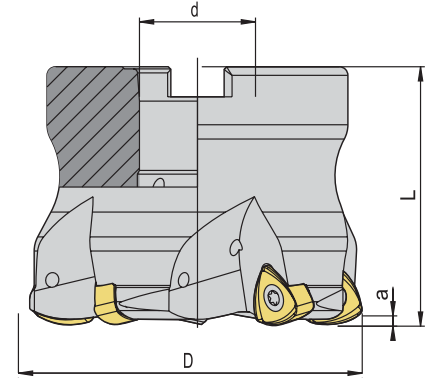
HIGH FEED MILLING TOOLS



Takım Kodu Ordering Code	Stok Stock	Kater Ölçüleri (mm) Dimension (mm)					Kesici Uç Insert	Yedek Parçaları Spare Parts	
		D	Z	d	L	a		Sıkma Vidası Clamp Screw	Tork Anahtar Torx Key
AHFM-BL1205-D050-A22-Z03-H	●	50	3	22	40	2	 BLMP 1205	 1515-M4x11	 80-T15
AHFM-BL1205-D063-A22-Z04-H	●	63	4	22	40	2			
AHFM-BL1205-D080-A27-Z05-H	●	80	5	27	50	2			

R: Sağ/Right L: Sol/Left ● Stokta/In Stock ○ Stokta Yok/Non Stock Item

Sipariş Örneği/Ordering Example : 1 ad./pcs. AHFM-BL1205-D050-A22-Z03-H
 Kesme Hesabı : S-144 / Cutting Calculation: P-144
 Montaj Ölçüleri : S-145 / Mounting Reference : P-145



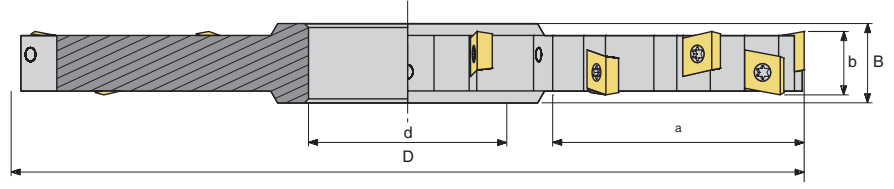

Takım Kodu Ordering Code	Stok Stock	Kater Ölçüleri (mm) Dimension (mm)							Kesici Uç Insert	Yedek Parçaları Spare Parts				
		Z		D	b	a	d	B		Sıkma Vidası Clamp Screw	Tork Anahtar Torx Key			
		TOPLAM TOTAL	ETKİLİ EFFECTIVE											
ASDM-SPM05-D80x6 -d27-Z10	●	10	5	80	6	17	27	10	SPMT 050203	3006-M2x4	80-T06			
ASDM-SPM05-D100x6-d32-Z12	●	12	6	100	6	25	32	10						
ASDM-SPM05-D125x6-d40-Z14	●	14	7	125	6	35	40	10						
ASDM-SPM05-D160x6-d40-Z18	○	18	9	160	6	52	40	10						
ASDM-SPM06-D80x7 -d27-Z10	●	10	5	80	7	17	27	11	SPMT 060204	3007-M2.2x5	80-T07			
ASDM-SPM06-D100x7-d32-Z12	●	12	6	100	7	25	32	11						
ASDM-SPM06-D125x7-d40-Z14	●	14	7	125	7	35	40	11						
ASDM-SPM06-D160x7-d40-Z16	○	16	8	160	7	52	40	11						
ASDM-SPM06-D200x7-d40-Z18	○	18	9	200	7	70	40	11	CC..0602..	3008-M2.5x6	80-T08			
ASDM-CC06-D80x8 -d27-Z10	●	10	5	80	8	17	27	12						
ASDM-CC06-D100x8 -d32-Z12	●	12	6	100	8	25	32	12						
ASDM-CC06-D125x8 -d40-Z14	●	14	7	125	8	35	40	12						
ASDM-CC06-D160x8 -d40-Z16	●	16	8	160	8	52	40	12						
ASDM-CC06-D200x8 -d40-Z18	●	18	9	200	8	70	40	12						
ASDM-CC06-D80x10 -d27-Z10	●	10	5	80	10	17	27	14						
ASDM-CC06-D100x10 -d32-Z12	●	12	6	100	10	25	32	14						
ASDM-CC06-D125x10 -d40-Z14	●	14	7	125	10	35	40	14						
ASDM-CC06-D160x10 -d40-Z16	○	16	8	160	10	52	40	14						
ASDM-CC06-D200x10 -d40-Z18	●	18	9	200	10	70	40	14						
ASDM-CC09-D80x12 -d27-Z08	●	8	4	80	12	17	27	16				CC..09T3..	1015-M3.5x9	80-T15
ASDM-CC09-D100x12 -d32-Z10	●	10	5	100	12	25	32	16						
ASDM-CC09-D125x12 -d40-Z12	●	12	6	125	12	35	40	16						
ASDM-CC09-D160x12 -d40-Z14	●	14	7	160	12	52	40	16						
ASDM-CC09-D200x12 -d40-Z18	●	18	9	200	12	70	40	16						
ASDM-CC09-D80x14 -d27-Z08	●	10	5	80	14	17	27	18						
ASDM-CC09-D100x14 -d32-Z10	●	12	6	100	14	25	32	18						
ASDM-CC09-D125x14 -d40-Z12	●	14	7	125	14	35	40	18						
ASDM-CC09-D160x14 -d40-Z14	○	16	8	160	14	52	40	18						
ASDM-CC09-D200x14 -d40-Z18	●	18	9	200	14	70	40	18						
ASDM-CC12-D80x16 -d27-Z06	●	6	3	80	16	17	27	20	CC..1204..	1020-M5x11	80-T20			
ASDM-CC12-D100x16 -d32-Z08	○	8	4	100	16	25	32	20						
ASDM-CC12-D125x16 -d40-Z10	●	10	5	125	16	35	40	20						
ASDM-CC12-D160x16 -d40-Z12	○	12	6	160	16	52	40	20						
ASDM-CC12-D200x16 -d40-Z14	●	14	7	200	16	70	40	20						
ASDM-CC12-D80x18 -d27-Z06	○	6	3	80	18	17	27	22						
ASDM-CC12-D100x18 -d32-Z08	●	8	4	100	18	25	32	22						
ASDM-CC12-D125x18 -d40-Z10	●	10	5	125	18	35	40	22						
ASDM-CC12-D160x18 -d40-Z12	●	12	6	160	18	52	40	22						
ASDM-CC12-D200x18 -d40-Z14	●	14	7	200	18	70	40	22						
ASDM-CC12-D250x18 -d40-Z16	●	16	8	250	18	90	40	22						
ASDM-CC12-D80x20 -d27-Z06	○	6	3	80	20	17	27	24						
ASDM-CC12-D100x20 -d32-Z08	●	8	4	100	20	25	32	24						
ASDM-CC12-D125x20 -d40-Z10	●	10	5	125	20	35	40	24						
ASDM-CC12-D160x20 -d40-Z12	●	12	6	160	20	52	40	24						
ASDM-CC12-D200x20 -d40-Z14	●	14	7	200	20	70	40	24						
ASDM-CC12-D250x20 -d40-Z16	●	16	8	250	20	90	40	24						

R: Sağ/Right L: Sol/Left ● Stokta/In Stock ○ Stokta Yok/Non Stock Item

Sipariş Örneği/Ordering Example : 1 ad./pcs. ASDM-SPM05-D80x6-d27-Z10
Kesme Hesabı : S-144 / Cutting Calculation: P-144

T KANAL FREZELER

T SLOT MILLING

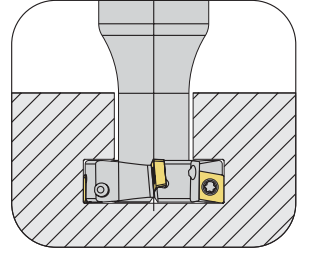
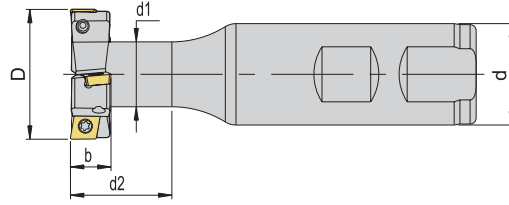

Takım Kodu Ordering Code	Stok Stock	Kater Ölçüleri (mm) Dimension (mm)								Kesici Uç Insert	Yedek Parçaları Spare Parts	
		Z		D	b	d	L	d1	d2		Sıkma Vidası Clamp Screw	Tork Anahtar Torx Key
		TOPLAM TOTAL	ETKİLİ EFFECTIVE									
ATSM90-CC06-D17X8- W16-L85- Z02	●	2	1	17	8	16	85	10	16	CC.. 0602..	3008-M2.5x6	80-T08
ATSM90-CC06-D32X8- W25-L100-Z04	●	4	2	32	8	25	100	16	23			
ATSM90-CC06-D63X8- W32-L125-Z08	●	8	4	63	8	32	125	31.5	30			
ATSM90-CC06-D18X9- W16-L90- Z02	●	2	1	18	9	16	90	10	16			
ATSM90-CC06-D20X9- W16-L85- Z04	●	4	2	20	9	16	85	10	16			
ATSM90-CC06-D23X10- W20-L90- Z04	●	4	2	23	10	20	90	12	25			
ATSM90-CC06-D32X10- W25-L100-Z04	●	4	2	32	10	25	100	16	25			
ATSM90-CC06-D45X10- W32-L120-Z06	●	6	3	45	10	32	120	20	25			
ATSM90-CC06-D25X11- W25-L100-Z04	●	4	2	25	11	25	100	13	20	CC.. 09T3..	1015-M3.5x9	80-T15
ATSM90-CC09-D30X12- W25-L100-Z04	●	4	2	30	12	25	100	16	25			
ATSM90-CC09-D32X12- W25-L100-Z04	●	4	2	32	12	25	100	16	25			
ATSM90-CC09-D32X14- W25-L100-Z04	●	4	2	32	14	25	100	16	25			
ATSM90-CC09-D37X16- W32-L120-Z04	●	4	2	37	16	32	120	17	30			
ATSM90-CC09-D42X17- W32-L120-Z04	●	4	2	42	17	32	120	19	30			
ATSM90-CC09-D40X18- W32-L120-Z04	○	4	2	40	18	32	120	19	30			
ATSM90-CC12-D47X20- W32-L120-Z04	●	4	2	47	20	32	120	25	45			
ATSM90-CC12-D52X21- W32-L120-Z04	●	4	2	52	21	32	120	25	45	CC.. 1204..	1020-M5x11	80-T20
ATSM90-CC12-D50X22- W32-L120-Z04	○	4	2	50	22	32	120	25	45			
ATSM90-CC12-D55X22- W32-L120-Z04	●	4	2	55	22	32	120	25	45			

R: Sağ/Right L: Sol/Left ● Stokta/In Stock ○ Stokta Yok/Non Stock Item

Sipariş Örneği/Ordering Example : 1 ad./pcs. ATSM90-CC06-D17X8-W16-L85-Z02
Kesme Hesabı : S-144 / Cutting Calculation: P-144





TAKMA UÇLU MATKAP (U-DRILL) KULLANMA KILAVUZU

Matkabınızı CNC torna tezgahına bağlamadan önce taretin merkezden kaçık olup olmadığını kontrol etmeniz gerekir. Şayet taretinizde kaçıklık varsa, takma uçlu matkabınızı kesinlikle kullanmayınız. Taretin düzeltilmesi için yapılması gereken işlemler;

1. Taretin tutucusuna kullanacağınız takma uçlu matkabın çapında ve boyunda üzeri hassas olan silindirik bir parça bağlanır ve tezgahın X değeri sıfıra getirilir.
2. Tezgahın aynasına miknatıslı komprotör saati yerleştirilir. Saatin uç kısmı tarete bağlanmış olduğumuz parçanın üstüne temas ettirilir.
3. Aynanın üzerine bağlanmış olduğumuz miknatıslı komprotör ayna ile beraber 360 derece döndürülerek saatteki değişim oranına göre taretin sıfırlanması sağlanır.

TAKMA UÇLU MATKABINIZI CNC TORNAZIDA DAHA VERİMLİ KULLANMANIZ İÇİN GEREKLİ OLAN KESME HIZLARI ve DEVİRLERİ :

Grup No.	Malzeme Cinsi	Malzeme Öz.	Kesme Hızı Vc (mm/dk)
1	Çok Yumuşak İş Çelikleri	C1010, Otomat vb.	220
2	İmalat Çelik ve Döküm Malz.	C1030 - 106 vb.	200
3	Takım ve İmalat Çelikleri	CK-45, 4140, 7131 vb.	170
4	Sıcak İş ve Paslanmaz Çelikler	İmpaks vb.	150

Devir hesabı yapabilmek için önce malzemeyi seçiniz. Seçtiğiniz malzemenin kesme hızını (Vc) 1000 ile çarpıp 3.14'e bölmeliyiz. Çıkan değeri matkap çapına bölmeliyiz. **Örnek :** Malzememiz takım ve imalat çeliği (3. grup), matkap çapı 25 mm kesme hızı 170 ise $170 \times 1000 = 170000 / 3.14 = 54140$, $54140 / 25 = 2166$ devir çıkar (Tezgahın İş Mili Deviri). Tezgahın ilerlemesi kullanacağınız uçlarda alakalı olup 0.05 ile 0.10 arasında değişim gösterir. Kullanıcı kesici ucun kesişine göre bunu ayarlar.

İŞLEME MERKEZLERİ İÇİN İLERLEME HESABI :

Yukarıdaki hesaplamalarla bulmuş olduğumuz 2166 mili devrini, kesici uç ilerlemesi (mm/devir) 0.05 ile 0.10 arasındaki ilerleme seçenekleri ile çarpılır. **Örnek 1 :** $2166 \times 0.05 = 108$ **Örnek 2 :** $2116 \times 0.10 = 217$ çıkan sonuçlar 108 ve 217 işleme merkezleri için ilerleme mm/dakika hesabıdır.

USER'S GUIDE FOR AKKO U-DRILLS

Before connecting your U-Drill to CNC lathe, you have to check if the turret is eccentric from the center or not. If there is any eccentricity in your turret, never use your U-Drill. , Processes that should be done to fix the turret :

1. A cylindrical part whose surface is precision and whose length and diameter is the same with the U-Drill that you will use, should be mounted to the holder of turret and X value of the lathe should be brought to zero (0).
2. Comparator should be mounted to chuck. The end of the comparator should be contacted (touched) to the surface of the part that we mounted on the turret.
3. The comparator that we mounted on the chuck should be turned 360-degree with the chuck and turret should be zeroed by that turning according to changing rate of comparator.

CUTTING SPEED AND REVOLUTION THAT ARE NEEDED FOR USING (RUNNING) YOUR U-DRILLS MORE PRODUCTIVELY

Grup No.	Material	Material Type	Cutting Speed Vc (mm/m)
1	Non-alloy steel and free cutting steel	C1010, Automat etc.	220
2	Low alloy steel and cast steel	C1030 - 106 etc.	200
3	Alloy steel and tool steel	CK-45, 4140, 7131 etc.	170
4	Hot Work Steel and Stainless Steel	Impax etc.	150

P.S. : The cutting speed may be concerned with the type of the insert that you use.

Firstly, choose the material to make calculation of revolution. You should multiply the cutting speed (Vc) of the material that you chose by 1000 and divide by 3.14. You should divide the value that you found by the diameter of U-Drill. **For Example :** If our material is alloy steel and tool steel (3rd group), diameter of the U-Drill is 25 mm, cutting speed is 170, we should calculate as following; $170 \times 1000 = 170000 / 3.14 = 54140$, $54140 / 25 = 2166$ rpm is the result that we found (Spindle Speed) Feed rate of the lathe is concerned with the U-Drill that you will use and changes between 0.05 and 0.10. The user sets it according to cut of cutting insert.

FEED CALCULATION FOR CENTRAL MACHINE :

2166 spindle speed, that we found as a result of above mentioned calculation, should be multiplied by cutting insert feed (mm/r) between 0.05 and 0.10 feed choises. **Example 1 :** $2166 \times 0.05 = 108$ **Example 2 :** $2116 \times 0.10 = 217$
The results 108 and 217 are the feed mm/m calculation for central machine.

FREZELEME İŞLEMİNDE DEVİR ve İLERLEME HESABI

Vc.	S	D	F	Z	fz	FORMÜLLER
Kesme Hızı (Uç Kutusunun Arkasından Okuyun)	İş Mili Devir Sayısı	Tarama Kafası Çapı	İlerleme	Etkili Ağız Sayısı	Diş Başına Düşen İlerleme Miktarı (Uç Kutusunun Arkasından Okuyun)	Devir Hesabı : $S = (Vc \times 1000) / (3.14 \times D)$ İlerleme Hesabı : $F = S \times Z \times fz$

Örnek: D=50 mm çapında, Z=5 ağızlı tarama kafası ile frezeleme yapacağız. Kesici uç kutusunun arkasında kesme hızı $Vc=200\text{m/dak}$ olarak verilmiş olsun. Tezgaha girilecek devri hesaplayalım: $Vc=200\text{ m/dak D=50 mm}$
 $S =$ Öncelikle Kesme Hızı 1000 ile çarpılır, çıkan sonuç 3,14 sayısına bölünür, buradan çıkan sonuç da tarama kafası çapına bölünür.
 $S = 200 \times 1000 = 200000 \rightarrow 200000/3,14 = 63663 \rightarrow 63663/50 = 1273$ devir $S=1273\text{ dev / dakika}$
 Deviri bulduktan sonra ilerlemeyi bulalım : $Z=5$ ağızlı tarama kafası olsun $fz=0,12$ olarak uç kutusunun arkasından okunmuş olsun $F =$ Yukarıda bulmuş olduğumuz devir sayısı ile ağız sayısı çarpılır, çıkan sonuç diş başına düşen ilerleme miktarı ile çarpılır.
 $F = 1273 \times 5 = 6365 \rightarrow 6365 \times 0,12 = 763$ $F = 763\text{ mm / dakika}$
 Tezgaha girilecek olan devir = S 1273 Tezgaha girilecek olan ilerleme = F 763 ortalama değerdir.
 Not : Vc ve fz değerlerinin uç kutusunun arkasında verilmiş olması gerekir. Eğer bu değerler uç kutusunun üzerinde yoksa, kesici ucun kataloğundan bulunuz. İşleyeceğiniz malzeme çelik ise P, paslanmaz çelik ise M, dökme demir ise K bölümünde yazılı olan Vc ve fz değerlerini okuyun.

CALCULATING SPINDLE SPEED and FEED RATE FOR MILLING PROCESS

Vc.	S	D	F	Z	fz	FORMULAS
Cutting Speed (Please read from the back side of cutting insert box)	Spindle Revolution rpm	Milling Tool Diameter	Feed Rate	Number of Effective Tooth	Feed Per Tooth (Please read from the back side of cutting insert box)	Calculation of Revolution : $S = (Vc \times 1000) / (3.14 \times D)$ Feed Rate Calculation : $F = S \times Z \times fz$

For Example : We will make milling with milling tool whose diameter is D 50 mm, whose teeth number is Z=5. The spindle revolution was written as $Vc=200\text{m/mn}$ at the back side of cutting insert box. Let's calculate the revolution that should be entered to the milling machine : $Vc=200\text{ m/m D=50 mm}$
 $S =$ Firstly Cutting Speed is multiplied with 1000, the result should be divided by 3.14 , the last result should be divided by diameter of milling tool.
 $S = 200 \times 1000 = 200000 \rightarrow 200000/3,14 = 63663 \rightarrow 63663/50 = 1273$ rev $S=1273\text{ rev / mn}$
 After finding spindle revolution, let's find feed rate : milling tool with $Z=5$ teeth and we read $fz=0,12$ from the back side of cutting insert box.
 $F =$ Tooth number should be multiplied with revolution, the result should be multiplied with feed per tooth.
 $F = 1273 \times 5 = 6365 \rightarrow 6365 \times 0,12 = 763$ $F = 763\text{ mm / mn}$
 Revolution that should be entered to the milling machine = S 1273 Feed Rate that should be entered to the milling machine = F 763 average value.
 P.S : The values Vc and fz have to be written at the back side of the cutting insert. If these values were not written on the cutting insert box, please find them from cutting insert catalogue. If the material that you will work is steel, please read Vc and fz values that were written on the part P, if it is stainless steel please read from the part M, if it is cast iron please read from the part K.

FREZELEME TAKIMLARI MONTAJ ÖLÇÜLERİ

MOUNTING REFERENCE FOR MILLING CUTTERS



A TİP
A TYPE

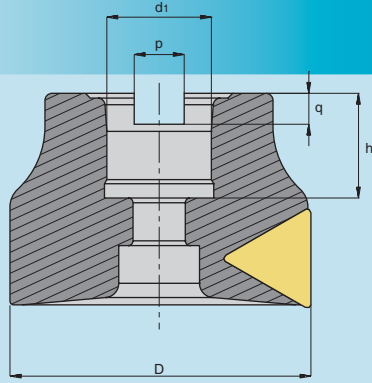

D	d ₁	d ₂	p	q	h
40	16	-	8,4	5,6	20
50	22	-	10,4	6,3	22
63	22	-	10,4	6,3	22
80	27	-	12,4	7	25
100	32	-	14,4	8	26

B TİP
B TYPE

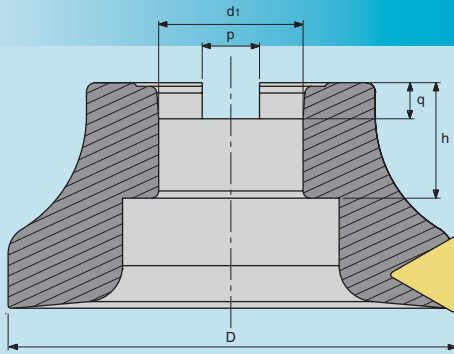

D	d ₁	d ₂	p	q	h
125	40	-	16,4	9	32

C TİP
C TYPE

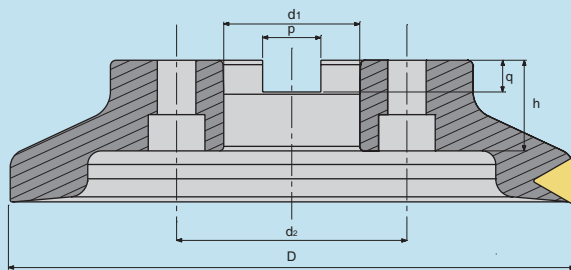

D	d ₁	d ₂	p	q	h
160	40	66,7	16,4	9	32
200	60	101,6	25,7	14	40
250	60	101,6	25,7	14	40

D TİP
D TYPE

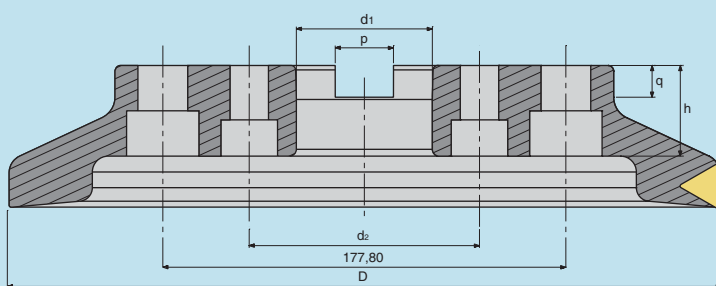

D	d ₁	d ₂	p	q	h
315	60	101,6	25,7	14	40





ALTLIKLAR / SHIMS

ÜRÜN RESMİ / PICTURE	ÜRÜN KODU / CODE	ÜRÜN DETAYI / PRODUCT DETAIL	
	AATN-2-0001	S-SİSTEM için / For S-SYSTEM	TCMT 16 ALTLIK / SHIM
	AATN-2-0002	T-M SİSTEM için / For T-M SYSTEM	TNMG 16 ALTLIK / SHIM
		C SİSTEM için / For C-SYSTEM	TNGN 16 ALTLIK / SHIM
	AATN-3-0025	P-SİSTEM için / For P-SYSTEM	TNMG 16 ALTLIK / SHIM
	AATN-3-0015	T-M-P SİSTEM için / For T-M-P SYSTEM	TNMG 22 ALTLIK / SHIM
	AATN-2-0020	DİŞ VİDA 16 / For THREADING 16	
	AATN-2-0004	DİŞ VİDA 22 / For THREADING 22	
	AACN-2-0001	S-SİSTEM için / For S-SYSTEM	CCMT 09 ALTLIK / SHIM
T-SİSTEM için / For T-SYSTEM		CNMG 09 ALTLIK / SHIM	
	AACN-2-0003	S-SİSTEM için / For S-SYSTEM	CCMT 12 ALTLIK / SHIM
	AACN-3-0001	T-P-M SİSTEM için / For T-P-M SYSTEM	CNMG 12 ALTLIK / SHIM
		C-SİSTEM için / For C-SYSTEM	CNGN 12 ALTLIK / SHIM
	AACN-3-0002	T-P SİSTEM için / For T-P SYSTEM	CNMG 16 ALTLIK / SHIM
	AACN-3-0003	T-P SİSTEM için / For T-P SYSTEM	CNMG 19 ALTLIK / SHIM
	AACN-3-0008	T-P SİSTEM için / For T-P SYSTEM	CNMG 25 ALTLIK / SHIM
	AAWN-3-0001	T-M-P SİSTEM için / For T-P-M SYSTEM	WNMG 08 ALTLIK / SHIM
	AAWN-SW317	T-M-P SİSTEM için / For T-P-M SYSTEM	WNMG 06 ALTLIK / SHIM
	AKS-16L	C-SİSTEM için / For C-SYSTEM	KNUX-L 16 ALTLIK / SHIM
AKS-16R		C-SİSTEM için / For C-SYSTEM	KNUX-R 16 ALTLIK / SHIM
	AASN-2-0001	S-SİSTEM için / For S-SYSTEM	SCMT 09 ALTLIK / SHIM
	AASN-2-0004	S-SİSTEM için / For S-SYSTEM	SCMT 12 ALTLIK / SHIM
	AASN-3-0004	T-P SİSTEM için / For T-P SYSTEM	SNMG 12 ALTLIK / SHIM
		C SİSTEM için / For C-SYSTEM	SNGN 12 ALTLIK / SHIM
	AASN-3-0023	T-P SİSTEM için / For T-P SYSTEM	SNMG 15 ALTLIK / SHIM
	AASN-3-0005	T-P SİSTEM için / For T-P SYSTEM	SNMG 19 ALTLIK / SHIM
	AASN-3-0020	T-P SİSTEM için / For T-P SYSTEM	SNMG 25 ALTLIK / SHIM
	AASN-20020	PSDNN KARTUŞ için / For PSDNN CARTRIDGE	SNMG 12 ALTLIK / SHIM
	AADN-2-0001	S-SİSTEM için / For S-SYSTEM	DCMT 11 ALTLIK / SHIM
		T-SİSTEM için / For T-SYSTEM	DNMG 11 ALTLIK / SHIM
	AADN-SD317	P-SİSTEM için / For P-SYSTEM	DNMG 11 ALTLIK / SHIM
	AADN-3-0001	T-SİSTEM için / For T-SYSTEM	DNMG 15 ALTLIK / SHIM
		C-SİSTEM için / For C-SYSTEM	DNGN 15 ALTLIK / SHIM
	AAVN-2-0002	S-SİSTEM için / For S-SYSTEM	VBMT 16, VCMT 16 ALTLIK / SHIM
		T-SİSTEM için / For T-SYSTEM	VNMG 16 ALTLIK / SHIM

BASKI PABUCLARI / CLAMPS

ÜRÜN RESMİ / PICTURE	ÜRÜN KODU / CODE	ÜRÜN DETAYI / PRODUCT DETAIL	
	ATK-01	T-SİSTEM için / For T-SYSTEM	DNMG 11, WNMG 06, TNMG 16, CNMG 09 BASKI PABUCU / CLAMP
	ATK-02	T-SİSTEM için / For T-SYSTEM	CNMG 12, WNMG 08, TNMG 22, DNMG 15, SNMG 12 BASKI PABUCU / CLAMP
	ATK-03	T-SİSTEM için / For T-SYSTEM	VNMG 16 BASKI PABUCU / CLAMP
	ATK-04	T-SİSTEM için / For T-SYSTEM	CNMG 16 BASKI PABUCU / CLAMP
	AMK-01	M-SİSTEM için / For M-SYSTEM	WNMG 06 BASKI PABUCU / CLAMP
	AMK-02	M-SİSTEM için / For M-SYSTEM	DELİK İÇİ / INTERNAL Ø20 TNMG 16 - Ø25 MT-NR/L 16 BASKI PABUCU / CLAMP
	AMK-03	M-SİSTEM için / For M-SYSTEM	DNMG 11, CNMG 12 BASKI PABUCU / CLAMP
	AMK-04	M-SİSTEM için / For M-SYSTEM	DNMG 15, TNMG 16-22 BASKI PABUCU / CLAMP
	AMK-05	M-SİSTEM için / For M-SYSTEM	WNMG 08 BASKI PABUCU / CLAMP
	ACK-01	C-SİSTEM için / For C-SYSTEM	KNUX-R BASKI PABUCU / CLAMP
	ACK-02	C-SİSTEM için / For C-SYSTEM	KNUX-L BASKI PABUCU / CLAMP
	ACK-03	C-SİSTEM için / For C-SYSTEM	154.91 DIŞ ÇAP - DELİK İÇİ / EXTERNAL - INTERNAL Ø25-Ø32 BASKI PABUCU / CLAMP
	ACK-04	C-SİSTEM için / For C-SYSTEM	CTFPR KARTUŞ BASKI PABUCU / CARTRIDGE CLAMP
	ACK-05	P-C SİSTEM için / For P-C-SYSTEM	FREZELEME ve DİŞ VİDA AÇMA TAKIMLARINA GÖRE İLAVE BASKI PABUCU ADDITIONAL LITTLE CLAMP for MILLING and THREADING CLAMP
	ACK-06	C-SİSTEM için / For C-SYSTEM	154.91 DELİK İÇİ Ø16-Ø20 BASKI PABUCU 154.91 INTERNAL Ø16-Ø20 CLAMP
	ACK-07	C-SİSTEM için / For C-SYSTEM	SERAMİK CNGN, SNGN, DNGN YEDEK TAKIMI SPARE PART SET of CNGN, SNGN, DNGN
	ACK-08	C-SİSTEM için / For C-SYSTEM	SERAMİK TNGN YEDEK TAKIMI SPARE PART SET of TNGN
	ACK-09	P-SİSTEM için / For C-SYSTEM	CNMG 16-19, SNMG 15-19 BASKI PABUCU CLAMP for CNMG 16-19, SNMG 15-19

BASKI PABUCLARI / CLAMPS

ÜRÜN RESMİ / PICTURE	ÜRÜN KODU / CODE	ÜRÜN DETAYI / PRODUCT DETAIL	
	ACK-10	C-SİSTEM FREZELEME için / For C-SYSTEM MILLING	SPKN 12 ve Ø50-63 TPKN 16 BASKI PABUCU / CLAMP
	ACK-11	C-SİSTEM FREZELEME için / For C-SYSTEM MILLING	TPKN 16-22, OFKR 07, HNMX 09 BASKI PABUCU / CLAMP
	ACK-12	C-SİSTEM için / For C-SYSTEM	CTSPR KARTUŞ BASKI PABUCU / CARTRIDGE CLAMP
	ACK-15	S-SİSTEM FREZELEME için / For S-SYSTEM MILLING	RD.. 10-12 BASKI PABUCU / CLAMP

BASKI PABUC VİDALARI / CLAMP SCREWS

ÜRÜN RESMİ / PICTURE	ÜRÜN KODU / CODE	ÜRÜN DETAYI / PRODUCT DETAIL	
	AKV-01-M5x20	T-SİSTEM için / For T-SYSTEM	DNMG 11, WNMG 06, TNMG 16 BASKI PABUC VİDASI / CLAMP SCREW
	AKV-02-M6x20	T-SİSTEM için / For T-SYSTEM	CNMG 12, WNMG 08, TNMG 22, DNMG 15, SNMG 12-15 VNMG 16 BASKI PABUC VİDASI / CLAMP SCREW
		M-SİSTEM için / For M-SYSTEM	TNMG 16-22, DNMG 15 BASKI PABUC VİDASI / CLAMP SCREW
	AKV-03-M6x20	M-SİSTEM için / For M-SYSTEM	WNMG 08 BASKI PABUC VİDASI / CLAMP SCREW
	AKV-04-M5x20	M-SİSTEM için / For M-SYSTEM	WNMG 06, DNMG 11, CNMG 12, DELİK İÇİ / INTERNAL Ø20 TNMG 16 BASKI PABUC VİDASI / CLAMP SCREW
	AKV-05-M6x25	T-SİSTEM için / For T-SYSTEM	CNMG 16 BASKI PABUC VİDASI / CLAMP SCREW
	AKV-06-M6x20	C-SİSTEM için / For C-SYSTEM	KNUX 16 BASKI PABUC VİDASI / CLAMP SCREW
	AKV-07-M6x20	C-SİSTEM için / For C-SYSTEM	154.91 BÜYÜK BASKI PABUC VİDASI 154.91 BIG CLAMP SCREW
	AKV-10-M6x15	C-SİSTEM için / For C-SYSTEM	154.91 KÜÇÜK BASKI PABUC VİDASI 154.91 SMALL CLAMP SCREW
	AKV-11-M8x33	C-SİSTEM için / For C-SYSTEM	TNGN, CNGN, DNGN, SNGN BASKI PABUC VİDASI / CLAMP SCREW



BASKI PABUC VİDALARI / CLAMP SCREWS

ÜRÜN RESMİ / PICTURE	ÜRÜN KODU / CODE	ÜRÜN DETAYI / PRODUCT DETAIL	
	AAV-05-M6x15	P SİSTEM için / For P SYSTEM	CNMG 16-19, SNMG 15-19 BASKI PABUCU VİDASI / CLAMP SCREW
	AKV-13-M8x1x16	C-SİSTEM FREZELEME için / For C SYSTEM MILLING	SPKN 12 ve Ø50-63 TPKN 16 BASKI PABUCU VİDASI / CLAMP SCREW
	AKV-14-M8x1x18	C-SİSTEM FREZELEME için / For C SYSTEM MILLING	TPKN 16-22, HNMX 09 BASKI PABUCU VİDASI / CLAMP SCREW
	AKV-15-M8x1x20	C-SİSTEM FREZELEME için / For C SYSTEM MILLING	OFKR 07 BASKI PABUCU VİDASI / CLAMP SCREW
	AKV-12-M5x9	C-SİSTEM için / For C SYSTEM	CTSPR ve CTFPR BASKI PABUCU VİDASI / CLAMP SCREW

ALTLIK VİDALARI / SHIM SCREWS

ÜRÜN RESMİ / PICTURE	ÜRÜN KODU / CODE	ÜRÜN DETAYI / PRODUCT DETAIL	
	AAV-01-M3x10	T-SİSTEM için / For T SYSTEM	WNMG 06, KNUX 16 ALTLIK VİDASI / SHIM SCREW
	AAV-02-M5x12	T-SİSTEM için / For T SYSTEM C-SİSTEM için / For C SYSTEM	CNMG 12, WNMG 08, TNMG 22, DNMG 15, SNMG 12 CNGN 12, SNGN 12, DNGN 15 ALTLIK VİDASI / SHIM SCREW
	AAV-03-M5x12	T-SİSTEM için / For T SYSTEM C-SİSTEM için / For C SYSTEM	TNMG 16 ALTLIK VİDASI / SHIM SCREW TNGN 16 ALTLIK VİDASI / SHIM SCREW
	AAV-04-M5x12	T-SİSTEM için / For T SYSTEM	VNMG 16, DNMG 11, CNMG 09 ALTLIK VİDASI / SHIM SCREW
	AAV-05-M6x15	T-SİSTEM için / For T SYSTEM	CNMG 16 ALTLIK VİDASI / SHIM SCREW CCMT 09, DCMT 11, VBMT 16, VCMT 16,
	AAV-06-M3.5x11	S-SİSTEM için / For S SYSTEM	TCMT 16, SCMT 09 ALTLIK VİDASI / SHIM SCREW DİŞ VİDA16 ALTLIK VİDASI / THREADING 16 SHIM SCREW
	AAV-07-M4.5x11	S-SİSTEM için / For S SYSTEM	CCMT 12, SCMT 12 ALTLIK VİDASI / SHIM SCREW DİŞ VİDA 22 ALTLIK VİDASI / THREADING 22 SHIM SCREW

BASKI PULU / STAMP

ÜRÜN RESMİ / PICTURE	ÜRÜN KODU / CODE	ÜRÜN DETAYI / PRODUCT DETAIL	
	ABPL-01	T-SİSTEM için / For T SYSTEM	DNMG 11-15, WNMG 06-08, TNMG 16-22, VNMG 16, CNMG 12, SNMG 12 BASKI PULU / STAMP
		M-SİSTEM için / For M SYSTEM	DELİK İÇİ / INTERNAL Ø25-Ø32-Ø40 ve DİŞ ÇAP / EXTERNAL TNMG 16-22, DNMG 15, WNMG 08 BASKI PULU / STAMP
		C-SİSTEM için / For C SYSTEM	KNUX 16 BASKI PULU / STAMP

SEKMAN / RING

ÜRÜN RESMİ / PICTURE	ÜRÜN KODU / CODE	ÜRÜN DETAYI / PRODUCT DETAIL	
	ACS-01	C Sistem için / For C SYSTEM	TNGN, CNGN, DNGN, SNGN SEKMANI / RING

BASKI YAYI / CLAMP SPRING

ÜRÜN RESMİ / PICTURE	ÜRÜN KODU / CODE	ÜRÜN DETAYI / PRODUCT DETAIL	
	AKY-01	T-SİSTEM için / For T SYSTEM	CNMG 12, WNMG 08, TNMG 22, DNMG 15, SNMG 12, VNMG 16 BASKI YAYI / CLAMP SPRING
	AKY-02	C-SİSTEM için / For C SYSTEM	KNUX 16 BASKI YAYI / CLAMP SPRING

PİM / PIN

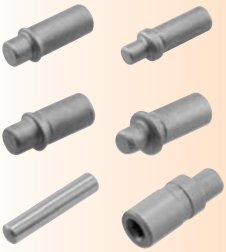
ÜRÜN RESMİ / PICTURE	ÜRÜN KODU / CODE	ÜRÜN DETAYI / PRODUCT DETAIL	
	APM-01	M-SİSTEM için / For M SYSTEM	DELİK İÇİ/INTERNAL Ø25-Ø32-Ø40 - DIŞ ÇAP/EXTERNAL TNMG 16 PİMİ / PIN
	APM-02	M-SİSTEM için / For M SYSTEM	TNMG 22, WNMG 08 PİMİ / PIN
	APM-03	M-SİSTEM için / For M SYSTEM	DELİK İÇİ/INTERNAL Ø20 TNMG 16, WNMG 06, DNMG 11 PİMİ / PIN
	APM-04	M-SİSTEM için / For M SYSTEM	CNMG 12, DNMG 15 PİMİ / PIN
	APM-05	M-SİSTEM için / For M SYSTEM	MSYNR KARTUŞ / CARTRIDGE SNMG 12 PİMİ / PIN
	APM-06	C-SİSTEM için / For C SYSTEM	154.91 PİMİ / PIN

LEVYELER / LEVERS

ÜRÜN RESMİ / PICTURE	ÜRÜN KODU / CODE	ÜRÜN DETAYI / PRODUCT DETAIL	
	APL-01	P-SİSTEM için / For P SYSTEM	DNMG 11, TNMG 16. WNMG 06 LEVYESİ / LEVER
	APL-02	P-SİSTEM için / For P SYSTEM	CNMG 12, SNMG 12, TNMG 22, WNMG 08 LEVYESİ / LEVER
	APL-03	P-SİSTEM için / For P SYSTEM	DNMG 15 LEVYESİ / LEVER
	APL-04	P-SİSTEM için / For P SYSTEM	CNMG 16, SNMG 15 LEVYESİ / LEVER
	APL-05	P-SİSTEM için / For P SYSTEM	CNMG 19, SNMG 19 LEVYESİ / LEVER
	APL-06	P-SİSTEM için / For P SYSTEM	CNMG 25, SNMG 25 LEVYESİ / LEVER

LEVYE VİDALARI / LEVER SCREWS

ÜRÜN RESMİ / PICTURE	ÜRÜN KODU / CODE	ÜRÜN DETAYI / PRODUCT DETAIL	
	ALV-01-M6x15	P-SİSTEM için / For P SYSTEM	DELİK İÇİ/INTERNAL Ø20 DNMG 11, Ø20 TNMG 16 LEVYE VİDASI / LEVER SCREW
	ALV-02-M6x17	P-SİSTEM için / For P SYSTEM	DNMG 11, TNMG 16. WNMG 06 LEVYE VİDASI / LEVER SCREW
	ALV-03-M8x19	P-SİSTEM için / For P SYSTEM	CNMG 12, SNMG 12, TNMG 22, WNMG 08, DNMG 15 LEVYE VİDASI / LEVER SCREW
	ALV-04-M8x22	P-SİSTEM için / For P SYSTEM	CNMG 16, SNMG 15 LEVYE VİDASI / LEVER SCREW
	ALV-05-M10x27	P-SİSTEM için / For P SYSTEM	CNMG 19, SNMG 19 LEVYE VİDASI / LEVER SCREW
	ALV-06-M12x36	P-SİSTEM için / For P SYSTEM	CNMG 25, SNMG 25 LEVYE VİDASI / LEVER SCREW

ALTLIK YAYI / SHIM SPRING

ÜRÜN RESMİ / PICTURE	ÜRÜN KODU / CODE	ÜRÜN DETAYI / PRODUCT DETAIL	
	AAY-01	P-SİSTEM için / For P SYSTEM	DNMG 11, TNMG 16, WNMG 06 ALTLIK YAYI / SHIM SPRING
	AAY-02	P-SİSTEM için / For P SYSTEM	CNMG 12, SNMG 12, TNMG 22, WNMG 08, DNMG 15 ALTLIK YAYI / SHIM SPRING
	AAY-03	P-SİSTEM için / For P SYSTEM	CNMG 16, SNMG 15 ALTLIK YAYI / SHIM SPRING
	AAY-04	P-SİSTEM için / For P SYSTEM	CNMG 19, SNMG 19 ALTLIK YAYI / SHIM SPRING
	AAY-05	P-SİSTEM için / For P SYSTEM	CNMG 25, SNMG 25 ALTLIK YAYI / SHIM SPRING

TORK VİDALARI / TORX SCREWS

ÜRÜN RESMİ / PICTURE	ÜRÜN KODU / CODE	ÜRÜN DETAYI / PRODUCT DETAIL	
	3006-M1.8x4	TORK VİDA / TORX SCREW	
	3006-M2x4	TORK VİDA / TORX SCREW	
	3007-M2.2x5	TORK VİDA / TORX SCREW	
	4006-M2.2x5	TORK VİDA / TORX SCREW	
	1008-M2.5x5	TORK VİDA / TORX SCREW	
	3208-M2.5x6.4	TORK VİDA / TORX SCREW	
	1008-M2.5x7	TORK VİDA / TORX SCREW	
	3008-M2.5x6	TORK VİDA / TORX SCREW	
	3008-M3x7	TORK VİDA / TORX SCREW	
	4008-M3x8	TORK VİDA / TORX SCREW	
	1008-M3x9	TORK VİDA / TORX SCREW	
	4015-M3.5x8	TORK VİDA / TORX SCREW	
	1615-M3.5x9	TORK VİDA / TORX SCREW	
	4015-M3.5x9	TORK VİDA / TORX SCREW	
	1410-M3.5x9	TORK VİDA / TORX SCREW	
	1510-M3.5x9	TORK VİDA / TORX SCREW	
	4015-M3.5x10	TORK VİDA / TORX SCREW	
	1015-M3.5x11	TORK VİDA / TORX SCREW	
	1315-M3.5x11	TORK VİDA / TORX SCREW	
	4015-M3.5x12	TORK VİDA / TORX SCREW	
	1015-M3.5x14	TORK VİDA / TORX SCREW	
	1015-M4x11	TORK VİDA / TORX SCREW	
	1515-M4x9	TORK VİDA / TORX SCREW	
	1515-M4x11	TORK VİDA / TORX SCREW	
	4015-M4x12	TORK VİDA / TORX SCREW	
	1515-M4.5x11	TORK VİDA / TORX SCREW	
	1015-M4.5x12	TORK VİDA / TORX SCREW	
	1120-M4.5x12	TORK VİDA / TORX SCREW	
	4020-M4.5x12	TORK VİDA / TORX SCREW	
	1020-M4.5x16	TORK VİDA / TORX SCREW	
1020-M5x11	TORK VİDA / TORX SCREW		

KÜRESEL FREZE VİDALARI / BALL NOSE END MILLING SCREW

ÜRÜN RESMİ / PICTURE	ÜRÜN KODU / CODE	ÜRÜN DETAYI / PRODUCT DETAIL
	1210-M4x0.5x10	KÜRESEL FREZE VİDASI-R012 UÇ VİDASI / BALL NOSE END MILLING SCREW for R012
	1215-M5x0.5x12	KÜRESEL FREZE VİDASI-R016 UÇ VİDASI / BALL NOSE END MILLING SCREW for R016
	1215-M5x0.5x15	KÜRESEL FREZE VİDASI-R020 UÇ VİDASI / BALL NOSE END MILLING SCREW for R020
	1208-M3x7	KÜRESEL FREZE VİDASI-P3208 UÇ VİDASI / BALL NOSE END MILLING SCREW for P3208
	1215-M4x0.5x9	KÜRESEL FREZE VİDASI-P3210 UÇ VİDASI / BALL NOSE END MILLING SCREW for P3210
	1220-M5x0.5x9	KÜRESEL FREZE VİDASI-P3212 UÇ VİDASI / BALL NOSE END MILLING SCREW for P3212
	1220-M5x0.5x12	KÜRESEL FREZE VİDASI-P3216 UÇ VİDASI / BALL NOSE END MILLING SCREW for P3216
	1220-M5x0.5x15	KÜRESEL FREZE VİDASI-P3220 UÇ VİDASI / BALL NOSE END MILLING SCREW for P3220
	1220-M6x0.75x20	KÜRESEL FREZE VİDASI-P3225 UÇ VİDASI / BALL NOSE END MILLING SCREW for P3225
	1230-M8x0.75x24	KÜRESEL FREZE VİDASI-P3232 UÇ VİDASI / BALL NOSE END MILLING SCREW for P3232

MONTAJ VE AYAR VİDALARI / MOUNTING and ADJUST SCREWS

ÜRÜN RESMİ / PICTURE	ÜRÜN KODU / CODE	ÜRÜN DETAYI / PRODUCT DETAIL
	2506-M8x30	A16 MONTAJ VİDASI / MOUNTING SCREW
	2508-M10x30	A22 MONTAJ VİDASI / MOUNTING SCREW
	2510-M12x35	A27 MONTAJ VİDASI / MOUNTING SCREW
	2514-M16x35	A32 MONTAJ VİDASI / MOUNTING SCREW
	2504-M5x16	KARTUŞ MONTAJ VİDASI / CARTRIDGE MOUNTING SCREW
	2505-M6x16	KARTUŞ MONTAJ VİDASI / CARTRIDGE MOUNTING SCREW
	2506-M8x20	KARTUŞ MONTAJ VİDASI / CARTRIDGE MOUNTING SCREW
	2600-M5x13	KARTUŞ EKSENEL AYAR VİDASI / CARTRIDGE AXIAL ADJUST SCREW
	2600-M6x18	KARTUŞ EKSENEL AYAR VİDASI / CARTRIDGE AXIAL ADJUST SCREW
	2725-M5x10	KARTUŞ RADYAL AYAR VİDASI / CARTRIDGE RADIAL ADJUST SCREW
	2704-M8x20	KARTUŞ RADYAL AYAR VİDASI / CARTRIDGE RADIAL ADJUST SCREW

KANAL KATER VİDALARI / GROOVING TOOL SCREWS

ÜRÜN RESMİ / PICTURE	ÜRÜN KODU / CODE	ÜRÜN DETAYI / PRODUCT DETAIL
	AKV-02-M6x20	KANAL KATER VİDASI / GROOVING TOOL SCREWS
	2503-M4X10	KANAL KATER VİDASI / GROOVING TOOL SCREWS
	2503-M4X16	KANAL KATER VİDASI / GROOVING TOOL SCREWS
	2504-M5X16	KANAL KATER VİDASI / GROOVING TOOL SCREWS
	2505-M6X20	KANAL KATER VİDASI / GROOVING TOOL SCREWS
	2004-M8x20	KANAL KATER VİDASI / GROOVING TOOL SCREWS
	2004-M8x1x20	KANAL KATER VİDASI / GROOVING TOOL SCREWS

ALYAN ANAHTARLARI / ALLEN KEYS

ÜRÜN RESMİ / PICTURE	ÜRÜN KODU / CODE	ÜRÜN DETAYI / PRODUCT DETAIL
	AAL-01-2	2 mm ALYAN ANAHTARI / ALLEN KEYS
	AAL-02-2.5	2.5 mm ALYAN ANAHTARI / ALLEN KEYS
	AAL-03-3	3 mm ALYAN ANAHTARI / ALLEN KEYS
	AAL-05-4	4 mm ALYAN ANAHTARI / ALLEN KEYS
	AAL-07-5	5 mm ALYAN ANAHTARI / ALLEN KEYS

TORK ANAHTARLARI / TORX KEYS

ÜRÜN RESMİ / PICTURE	ÜRÜN KODU / CODE	ÜRÜN DETAYI / PRODUCT DETAIL
	80-T06	T06 TORK ANAHTARI / TORX KEY
	80-T07	T07 TORK ANAHTARI / TORX KEY
	80-T08	T08 TORK ANAHTARI / TORX KEY
	80-T10	T10 TORK ANAHTARI / TORX KEY
	80-T15	T15 TORK ANAHTARI / TORX KEY
	80-T20	T20 TORK ANAHTARI / TORX KEY

EKSANTRİK VİDA / EXCENTRIC SCREW

ÜRÜN RESMİ / PICTURE	ÜRÜN KODU / CODE	ÜRÜN DETAYI / PRODUCT DETAIL
	AEV-01-M6x16	PSDNN KARTUŞ EKSANTRİK VİDASI / CARTRIDGE EXCENTRIC SCREW



Konuşulan Kalite

The Spoken Quality



TS EN ISO 9001:2008

KONUSULANKALİTE



The Spoken Quality



Qualität über die man spricht





Yetkili Satıcı / Authorized Agency



AKKO MAKİNA TAKIM SAN. TİC. LTD. ŞTİ.

KONYA ORGANİZE SANAYİ BÖLGESİ
IŞIKTEPE SOKAK NO: 6 P.K. 42050
KONYA / TÜRKİYE

TEL : +90 332 239 17 57 (pbx)

FAX : +90 332 239 17 52

Web : www.akko.com.tr

e-posta : akko@akko.com.tr

Bu katalogdaki kodlar, fotoğraflar ve bilgiler izin alınmadan kullanılamaz, hiçbir şekilde kopyalanamaz ve dijital ortamda yayınlanamaz. AKKO; ürünlerinde, kodlarında ve özelliklerinde değişiklik yapma hakkını saklı tutar.
Codes and photographs in this catalog can not be used, copied or published in any digital place without permission. AKKO reserves the right to make changes on products, codes and specifications.