

1985'den beri...
SINCE 1985...





MERKEZ OFİS / Head Office



ŞUBE KARAKÖY / Branch- KARAKOY

pvd Ltd.Şti. 1985 yılında kurulmuştur. Üretim, ithalat ve ihracat yapmaktadır.

Üretimde SOLENOİD VALFLER, PNÖMATİK AKTÜATÖRLER, PATLAÇ VALFLER, SINIR ŞALTER KUTULARI (SWITCHBOX) ve OTOMATİK VANALAR yer alır.

Ayrıca Proses ölçü ve kontrol cihazları konusunda temsilcilikleri vardır, ve pek çok ürünü müşterilerine sunabilmektedir.

Çalışmalarını şirketin sahip olduğu Dudullu'daki 1200 m² kapalı ve 1000 m² açık kullanım alanı olan yerinde sürdürmektedir.

ISO 9001 ve CE belgeleri ile sertifikalandırılmış olan **pvd Ltd.Şti.** yurt içindeki 30'dan fazla ve yurtdışındaki 10 bayisi ile satışlarını yaygınlaştırmaktadır.

pvd Ltd.Şti. established in 1985, serves lots of industrial establishments in and out of the country by producing, exporting and importing.

In addition to our Automatic Valves and Pneumatic Rotary Actuators, which are our main products, we introduce lots of products of the firms we represent to the buyers.

At the moment, **pvd**, which continues its activities in a factory building of 1200 m², granted with a ISO 9001 and CE certificate in 2003, continuously enlarges its service net with more than 30 domestic distributors.



pvd Kalitesi
26 yıllık deneyim
Geniş üretim çeşidi

pvd Quality
26 years of experience
Wide product range

Temsilcisi Olduğumuz Firmalar Representatives

	16
	14
Young Tech Co., Ltd	13
	15
	15
	19

Marka tescil belgesinde görüldüğü gibi T-GM 100, T-BU 200, T-VA 300, T-YA 400, T-PA 000, T-PAT 500, T-PVD 700 markaları PVD'ye aittir.



1

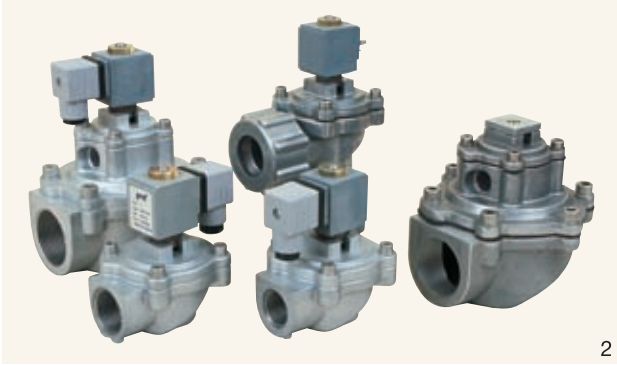

2



3



4



5

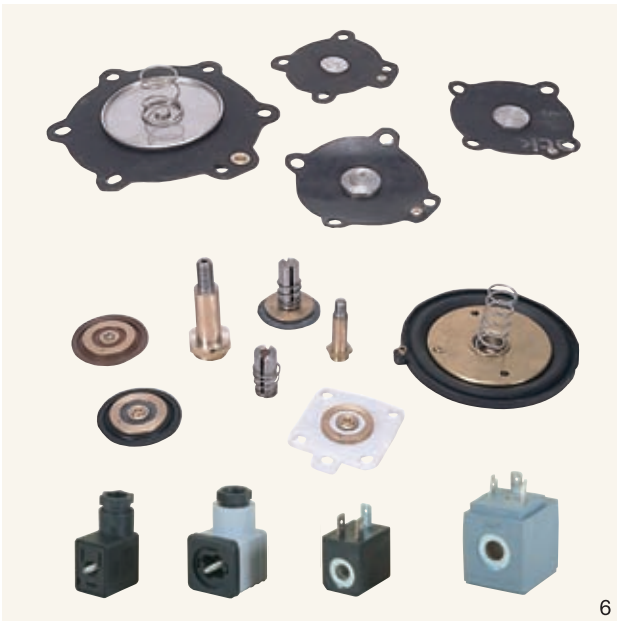

6

Solenoid Valfler, elektrik enerjisi ile çalışır ve akışkanın otomatik olarak kontrol edilmesi gerektiği her yerde kullanılmaktadır. Teknolojinin gelişimine uygun olarak kullanma alanları daha da artmaktadır.

Solenoid Valfler, elektrik enerjisinin bir bobin yardımıyla oluşturduğu manyetik alanın bir takım parçaları hareket ettirmesi prensibinden yararlanarak geliştirilmiştir.

İstenilen prosese göre Solenoid Valfler 2 veya daha çok yollu ve değişik ölçülerde üretilirler. Kullanılacak elektrik enerjisinin değeri de yine prosese göre 6, 12, 24, 48, 72, 110, 220V AC veya DC olarak seçilebilir.

Solenoid Valflerde yaygın olarak kullanılan gövde malzemesi pirinçtir, (MS 58), ancak özel olarak paslanmaz çelik, bronz, dökme demir, çelik veya plastik gövdeli solenoid valfler de üretilmektedir.

Çalışma prensibine göre Solenoid Valfleri, direk çekmeli ve pilot kumandalı olarak iki ana grupta toplamak mümkündür. Ayrıca akışkan cinslerine göre de Solenoid Valfleri çeşitli gruplara ayırabiliriz. Bunların dışında Solenoid Valfler elektrik varken açık ya da kapalı olarak tasarlanabilirler. Bu valfin Normalde Açık veya Normalde Kapalı durumu olarak belirtilir.

Solenoid valves are operated with the power of electric and used almost everywhere where the fluids are controlled automatically. Parallel to the technologic development it fields of usage have been increasing.

Solenoid valves have been derived from the principal that a magnetic field, formed by the electric energy with the help of a coil, moves some mechanic parts.

Depending on the project Solenoid Valves can be produced with 2 or more ways and in different sizes. Also the electric supply can be 6, 12, 24, 48, 72, 110, 220 V AC or DC according to project.

In solenoid Valves the widely used body material is brass, but stainless steel, bronze, cast iron, steel or plastic body valves can be produced as well.

According to working principle Solenoid Valves can be classified into two main groups as 'Direct Acting' and pilot operated. Besides, these valves can be classified according to fluid types. Apart from these Solenoid Valves can be designed as on or off when electricity is on. This is mentioned as the valve is Normally Open or Normally Closed.



T - GM 100

(- 20 / + 80 °C)

GENEL MAKSAT SOLENOİD VALFLERİ
su, hava, asal gazlar, hafif yağlar vbg. için

GENERAL PURPOSE SOLENOID VALVES
for water, air, inert gas, light oil etc.

2 veya 3 yollu, NK, direkt çekmeli, ölçüler: 1/8" - 1/4"
2 and 3 way, NC, direct operated, sizes: 1/8" - 1/4"



2 yollu, NK, direkt çekmeli, büyük orifisli, ölçüler: 1/4" - 1/2"
2 way NC, direct operated, large orifice, sizes :1/4" - 1/2"



2 yollu, NK veya NA, pilot kumandalı, diyaframlı, ölçüler :3/8" - 3"



T - BU 200

(- 20 / + 170 °C)

BUHAR SOLENOİD VALFLERİ
sıcak su, buhar için

STEAM SOLENOID VALVES
for hot water, steam

2 yollu, NK veya NA, direkt çekmeli, ölçüler:1/8" - 1/2"
2 way, NC or NO, direct operated, sizes :1/8" - 1/2"



2 yollu, NK veya NA, pilot kumandalı, diyaframlı, ölçüler :1/2" - 2"
2 way, NC or NO, pilot operated, with diaphragm, sizes :1/2" - 2"

NK: Normalde Kapalı, NA: Normalde Açık / NC: Normally Closed, NO: Normally Open



12

T - VA 300

(- 20 / + 80 °C)

DÜŞÜK BASINÇ ve VAKUM SOLENOİD VALFLERİ
su, hava, asal gazlar, hafif yağlar vbg. için
LOW PRESSURE and VACUUM SOLENOID VALVES
for water, air, inert gas, light oil etc.

2 yollu, NK, direkt çekmeli, ölçüler: 1/8 " - 1 "
2 way NC, direct operated, sizes :1/8" - 1"



13

T - YA 400

(- 10 / + 160 °C)

YAKIT SOLENOİD VALFLERİ

fuel oil, mazot, hidrolik yağ için

FUEL SOLENOID VALVES

for fuel oil, diesel oil, hydraulic oil

2 veya 3 yollu, NK veya NA, direkt çekmeli, ölçüler :1/8" - 1/4"
2 or 3 way, NC or NO, direct operated, sizes :1/8" - 1/4"



14



15

2 yollu, NK veya NA, pilot kumandalı, diyaframlı, ölçüler :3/8" - 2"
2 way, NC or NO, pilot operated, with diaphragm, sizes :3/8" - 2"



16

2 yollu, NK veya NA, pilot kumandalı, diyaframlı, ölçüler :3/8" - 2"
2 way, NC or NO, pilot operated, with diaphragm, sizes :3/8" - 2"

NK: Normalde Kapalı, NA: Normalde Açık / NC: Normally Closed, NO: Normally Open



T - 600 SS
(- 20 / + 160 °C)

PASLANMAZ ÇELİK SOLENOİD VALFLER
su, hava, kimyasal maddeler, gıda vb. için
STAINLESS STEEL SOLENOID VALVES
for water, air, chemicals, food etc...

2 veya 3 yollu, NK, direkt çekmeli, ölçüler :1/8" - 1/4"
2 or 3 way, NC , direct operated, sizes :1/8" - 1/4"



2 yollu, NK, direkt çekmeli, ölçüler :3/8" - 3/4"
2 way, NC , direct operated, sizes :3/8" - 3/4"



ÖZEL ÇEKME SOLENOİDİ

Strok : 15 mm
Çalışma Gerilimi 24 V DC

SPECIAL HOLDING SOLENOID
Stroke : 15 mm
Supply Voltage : 24 V DC



ZAMAN RÖLESİ

Model : T - EZ - 1
Çalışma Aralığı : 0.5 - 10 sec.
Bekleme Aralığı : 0.5 - 145 dk.

TIMER

Model : T - EZ - 1
Operating time : 0.5 - 10 sec.
Waitingtime : 0.5 - 45 min.



ZAMAN RÖLELİ SOLENOİD VALFLER

Zaman rölesi, takıldığı solenoid valfi belirlenen zaman aralıklarında çalıştırır ve durdurur.

SOLENOID VALVES WITH TIMER

Timer operates the solenoid valve in adjusted times.

NK: Normalde Kapalı, NA: Normalde Açık / NC: Normally Closed, NO: Normally Open



22

(- 20 / + 80 °C)

KOMPRESÖR SOLENOİD VALFLERİ
sıcak ve yağlı hava için
COMPRESSOR SOLENOID VALVES
for hot and oily air

2 veya 3 yollu, NK veya NA direkt çekmeli, ölçüler :1/8" - 1/4"
2 or 3 way, NC or NO direct operated, sizes :1/8" - 1/4"



23

2 yollu, NK veya NA, pilot kumandalı, diyaframlı, ölçüler :3/8" - 1"
2 way, NC or NO, pilot operated, with diaphragm, sizes :3/8" - 1"



24

Kaynak makinası solenoid valfleri (CQ ve Argon gazı için)
Welding machine solenoid valves (for CQ and Argon gas)

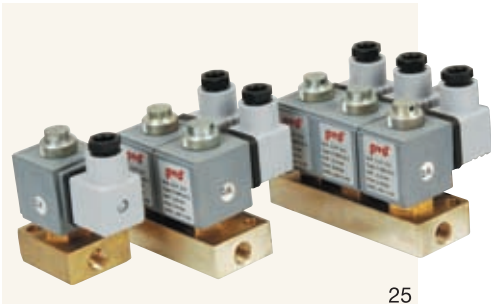

25

Özel amaçlar için grup solenoid valfleri
Grup Solenoid Valves for special purposes



26

Sulama sistemleri için büyük ölçü Solenoid Valfler, 3"
Large size Solenoid Valves for irrigation systems, 3"

NK: Normalde Kapalı, NA: Normalde Açık / NC: Normally Closed, NO: Normally Open

T - PAT 500

Kullanıldığı Yerler: Torbalı filtreler (Jet Filtre), Bunkerler
Sıcaklık : -10 / 80 °C
Application : Dust Filters (jet filters), bunkers
Temperature : -10 / 80 °C

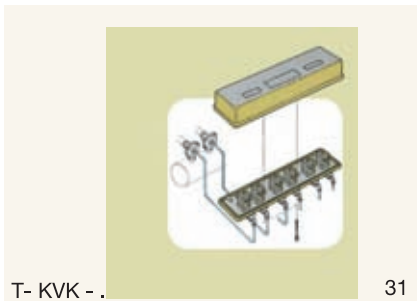
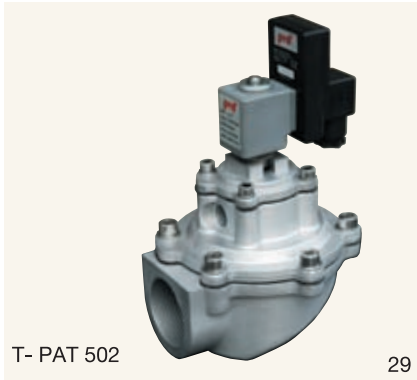
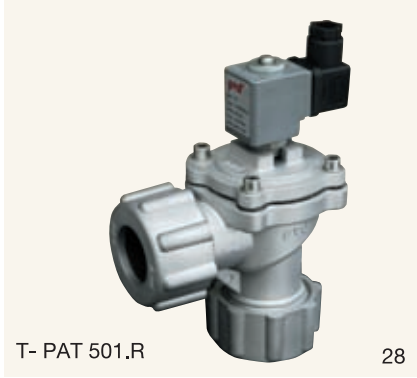

Model	Ölçü Size	Basınç Pressure (Bar)
T - PAT 500	G 3/4"	0.5 - 8
T - PAT 500.B	G 3/4"	
T - PAT 501	G 1"	
T - PAT 501.R	G 1"	
T - PAT 501.B	G 1"	
T - PAT 501.BR	G 1"	
T - PAT 502	G 1 1/2"	
T - PAT 502.B	G 1 1/2"	

B: Bobinsiz (Hava uyarılı) Modelleri Belirtilir.
B: Models without coil
R: Rekorlu Modelleri Belirtilir.
R: Coupling models
BR: Bobinsiz ve Rekorlu Modelleri Belirtilir.
BR: Models without coil and with coupling

Tanım : Patlaç valfler, basınçlı havanın hızlı bir şekilde boşaltılarak, şok hava darbeleri oluşturması istenen sistemler için geliştirilmiştir. Patlaç valfler de, diğer iki yollu solenoid valfler gibi çalışır, fakat giriş ve çıkış bağlantıları 90° açı oluşturur. Bu nedenle havayı darbe (şok) şeklinde gönderme özelliği vardır. Onun içindir ki hava şoklama valfi (Patlaç Valf, Jet Filtre Valfi) adı ile bilinir.

Definition : pvd dust bag shaker valves are designed for the systems that discharges pressured air swift and produce air strokes as shock. It operates in the same way with other 2-way solenoid valves. But input and output connections are perpendicular (90°) to each other. So it sends air as stroke (shock), and it is also called Air Shock (Jet Filter) valve.

PATLAÇ VALF ZAMAN RÖLESİ / DUST VALVE TIMER

Model	Açıklama Descripsi
T - ZR - 4	4 Çıkışı / Output
T - ZR - 8	8 Çıkışı / Output
T - ZR - 16	16 Çıkışı / Output
T - ZR - 32	32 Çıkışı / Output

Zaman röleleri filtre temizleme zamanlayıcısı olarak kullanılmak üzere tasarlanmıştır. Ayarlandığı zaman sürelerine göre Patlaç(Hava Şoklama) Valflerinin bobinlerini sırayla enerjilendirirler. Bobinler enerjilenince Patlaç Valfler şok halinde hava darbeleri oluştururlar. Timers are designed in order to use in filter systems. According to the adjusted intervals, timers are energize the coils of the dust valves in sequence. When the coils of the valves are energized it causes an air shock.

PATLAÇ VALF KONTROL KUTUSU
DUST VALVE CONTROL BOX

Model	Açıklama / Description
T - KVK - 4	Kontrol Kutusu (4'li) / Control Box
T - KVK - 5	Kontrol Kutusu (5'li) / Control Box
T - KVK - 6	Kontrol Kutusu (6'li) / Control Box
T - KVK - 7	Kontrol Kutusu (7'li) / Control Box
T - KVK - 8	Kontrol Kutusu (8'li) / Control Box
T - KVK - 9	Kontrol Kutusu (9'lu) / Control Box

Toza , suya ve diğer etkenlere karşı Solenoid Bobin kısımlarını korumak için kullanılır. Bir kutuya 10 bobin sığdırılabilir. Buradan Patlaç Valflere bağlantılar hortumla yapılır. In order to protect the Solenoid Operators from dust, water or other effects they are constructed in a control box.

It can be up to 10 Solenoid operators. Air connections will be done by hoses up to Dust Valves.

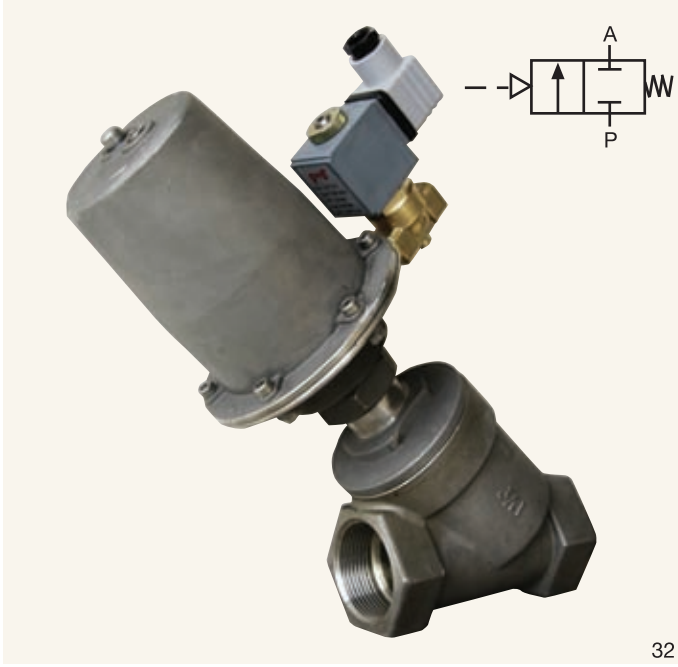

32

Gövde Malzemesi: AISI 316 Paslanmaz çelik
Aktüatör Malzemesi: AISI 316 Paslanmaz çelik
Çalışma Sıcaklığı : - 30 °C / +180 °C
Gövde Dayanım Basıncı : 40 bar
Sızdırmazlık Contası : PTFE (İstek üzerine VİTON, EPDM)
Konum : Normalde kapalı (NK)
Normalde Açık (NA)
Bağlantı : Dişi dişli (G), İstenirse Flanşlı
Gerekli Hava Basıncı : 6 bar

Body Material : AISI 316 Stainless Steel
Actuator Material : AISI 316 Stainless Steel
Working Temperature : - 30 °C / +180 °C
Pressure rating : 40 bar
Sealing : PTFE (on request VITON, EPDM)
Function : Normally Closed (NC)
Normally Open (NO)
Connection : Screwed female (G)
On Request Flanged
Required air pressure : 6 bar

NORMALDE KAPALI (NK) VE NORMALDE AÇIK (NA) TİPLERİ VARDIR
NORMALLY CLOSED (NC) AND NORMALLY OPEN (NO) TYPES ARE AVAILABLE

Ölçü Size	Tip Type	Geçiş Deliği Orifice mm	Çalışma Fark Basıncı Working Diff. Pressure (ΔP) Bar	Akış (Kv) Flow m3/h
1/2" G	T-PVD 700	15	16	3.8
3/4" G	T-PVD 701	20	10	8
1" G	T-PVD 702	25	6	15
1 1/4"G	T-PVD 703	32	12	23
1 1/2"G	T-PVD 704	40	8	30
2" G	T-PVD 705	50	6	46
1/2" G	T-PVD 700.1	15	40	3.8
3/4" G	T-PVD 701.1	20	30	8
1" G	T-PVD 702.1	25	20	15

A: Normalde açık (NA) Tipi için eklenir
A: Add for Normally open (NO) type



33

Kullanıldığı Yerler

- Gıda Sanayi
- Kimya Sanayi
- Makina Sanayi
- Demir Çelik Sanayi
- Çimento Sanayi
- İlaç Sanayi
- Kozmetik Sanayi
- pek çok diğeri
- Su
- Hava
- Buhar
- Kimyasal Madde
- Gıda
- Gaz
- Petrol
- Asit

Applications

- Textile Ind.
- Food Ind.
- Chemical Ind.
- Machine Ind.
- Iron and Steel Ind.
- Pharmaceutical Ind.
- Cosmetics Ind.
- many others
- Water
- Air
- Steam
- Chemicals
- Food
- Gas
- Petroleum
- Acids

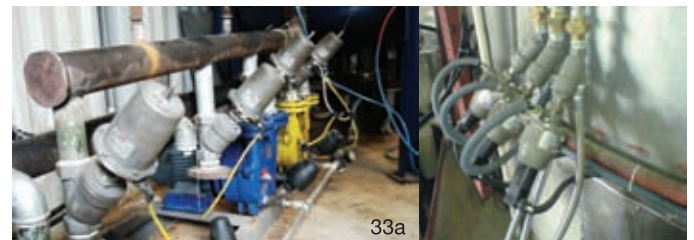



34



35



36

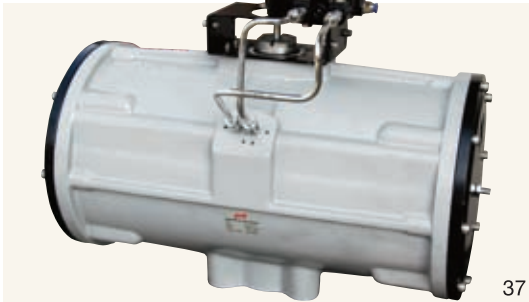

37



38



38a

38b

pvd Pnömatik aktüatörler; Küresel,Kelebek,Plug Vanalar ve benzeri 90° dönüş hareketi yapan sistemlerde, hızlı veya yavaş açma ya da oransal çalışma için güvenilir, az bakım gerektiren bir elemandır.

pvd Pnömatik Aktüatörleri, değişik ölçülerde çift etkili, ve tek etkili (yay dönüşlü) olarak üretilmektedir. Dişli tahrik sistemi sayesinde tüm dönüş boyunca sabit bir tork değeri elde edilmektedir. Bu, oransal kontrollü çalışma sistemlerinde aranan bir özelliktir.

Standart üretimin dışında, aktüatörler müşteri isteğine göre ±%10 strok ayarlı, 180° dönüşlü ve 3 pozisyonlu (tam açık, yarı açık, kapalı) olarak da üretilmektedir.

Ayrıca solenoid valf, açık-kapalı konum şalteri (mekanik veya elektronik), pozisyoner (pnömatik veya elektro-pnömatik) gibi aksesuarlarda isteğe bağlı olarak aktüatörle montajlı halde verilir.

pvd PNÖMATİK AKTÜATÖR ÖZELLİKLERİ;

Gövde : Alüminyum ekstrüzyon, yüzeyi sertleştirilmiş (T-PA 40, 50, 60, 70 ve 80 modelleri için.)

Alüminyum döküm ve epoxy boyalı (T-PA 90, 100, 120, 140, 150, 160, 200 ve 250 modelleri için.)

Pistonlar : Alüminyum döküm.

Mil : Çelik (Kadminyum kaplı) veya paslanmaz çelik.

Sızdırmazlık Elemanları : Nitril kauçuk, -20°C / +80°C

Yataklama malzemeleri: Endüstriyel sert plastik

Aktüatör / Vana bağlantısı :.....ISO

Solenoid vana bağlantısı :.....NAMUR

Pozisyoner ve limit switch bağlantısı :.NAMUR

Standartlarına uygundur.

***pvd** Pneumatic Actuators, are powerful, reliable and compact double rack and pinion units for use with ball, butterfly and plug valves and any device requiring accurate fast or slow or proportional 90° turn motion.*

***pvd** Pneumatic Actuators are manufactured in different sizes. Both double-acting and single acting spring return type. Because of the rack and pinion units, torque value is constant in complete movement.*

Besides standart manufacturing program, optionally pneumatic actuators can be manufactured with ±10% stroke adjustment, 180° turn and 3-position types.

As an accessory solenoid valve, limit switch(mechanical or proximity type), positioner(pneumatic or electro-pneumatic) can be installed over actuators optionally.

pvd PNEUMATIC ACTUATOR FEATURES;

Body Material : Extruded Aluminium, hard anodized (for type T-PA 40, 50, 60, 70 and 80)

Cast Aluminium and epoxy painted.

(For types T-PA 90, 100, 120, 140, 150, 160,200 and 250)

Pistons : Cast Aluminium

Pinion : Steel (cadmium plated) or stainless steel

Gasket : Nitrile rubber, -20°C / +80°C

Bearings : Easy sliding hard plastic

Actuator / Valve connections acc. to.....ISO

Solenoid valve connections acc. to.....NAMUR

Positioner and limit switch boxes acc. to...NAMUR

www.pvd.com.tr

Döndürme Moment Değerleri (p = 6 bar)

Torque Values (p = 6 bar)



39



39a



40



41

Çift Etkili Aktüatörler

Double Acting Actuators

Model	Nm
T - PA 40 CE	14
T - PA 50 CE	22
T - PA 60 CE	35
T - PA 70 CE	64
T - PA 80 CE	88
T - PA 90 CE	130
T - PA 100 CE	150
T - PA 120 CE	320
T - PA 140 CE	490
T - PA 150 CE	600
T - PA 160 CE	720
T - PA 200 CE	1500
T - PA 250 CE	2900

Tek Etkili Yay Dönüşlü Aktüatörler

Single Acting Spring Return Actuators

Model	Nm
T - PA 40 TE	4
T - PA 50 TE	7
T - PA 60 TE	13
T - PA 70 TE	21
T - PA 80 TE	32
T - PA 90 TE	44
T - PA 100 TE	62
T - PA 120 TE	108
T - PA 140 TE	165
T - PA 150 TE	200
T - PA 160 TE	250
T - PA 200 TE	500
T - PA 250 TE	960

PNÖMATİK KÜRESEL ve KELEBEK VANALAR

PNEUMATIC BALL and BUTTERFLY VALVES

Pnömatik Kelebek Vanalar

On-off veya oransal

Su, hava, toz madde, kimyasallar, gıda, deniz suyu vb.

Ölçüler : DN 25DN 800

Pneumatic Butterfly Valves

On-off or proportional

For water, air, dust material, chemicals, food, sea-water etc.

Size : DN 25.....DN800

Pnömatik Küresel Vanalar

On-off veya oransal

Su, hava, doğalgaz, LPG, kimyasallar, gıda, vb. için

Ölçüler : DN 8 (1/4").....DN 300 (12")

Pneumatic Ball Valves

On-off or proportional

For water, air, naturalgas, LPG, chemicals, food, etc.

Size : DN 8 (1/4").....DN 300 (12")



42



43



44



45

NAMUR VALF 5 - Yollu veya 3 - Yollu
NAMUR VALVE 5-Way or 3-Way

Kompresörden gelen basınçlı havayı yönlendirmek için kullanılır.
Bobin gerilimi : 12 - 24 - 110 - 220 V AC veya V DC olabilir. İsteğe bağlı Ex-Proof
Çalışma Basıncı : 2 - 10 Bar.
Sıcaklık : - 10 / + 50 °C

Used for controlling pressurized air coming from compressor.

Coil voltages can be : 12 - 24 - 110 - 220 V AC or V DC; Optionally Ex-Proof

Working Pressure : 2 - 10 Bar.

Temperature : -10 / + 50 °C

Model	Açıklama / Description
N - 525	5 / 2 (5 Yollu / 5 Way)
N - 323	3 / 2 (3 Yollu / 3 Way)

SINIR ŞALTER KUTULARI
LIMIT SWITCH BOXES



Sınır şalter kutuları, içindeki şalterler (mekanik mikroswitchler ya da proximity switch'ler) vasıtasıyla, aktüatörün bağlandığı vana ya da klapenin açık-kapalı konumlarında sinyal verme görevi yaparlar.

Özellikler;

Gövde Malzemesi : Siyah ABS

Şeffaf Gösterge : Polikarbonat

Kutu Koruma Sınıfı : IP 65

Şalterler : Mekanik; Crouzet 250 V AC 16 A

Proximity MEFA ; IFM; PEPPEREL- FUCHS vb.

Sıcaklık Aralığı : -20 °C ... 80 °C

İsteğe göre Ex-Proof sınır şalter kutusu

Switch boxes, which include two switches (mechanical or proximity) are indicate the "open - close" position of the valves or dampers which actuators are assembled.

Specifications;

Body Material : ABS Black

Transparent Indicator : Polycarbonate

Enclosure : IP 65

Switches : Mechanical; Crouzet 250 V AC 16 A

Proximity MEFA; IFM; PEPPEREL - FUCHS etc...

Temperature Range : -20 °C ... +80 °C

Optionally Ex-Proof limit switch box.

Sınır Şalter Kutusu / Limit Switch Box

Model	Açıklama / Description
SB - MB	2 Adet Mekanik Şalterli Göstergesiz 2 Each mechanical switches and without indicator.
SB - MF	2 Adet Mekanik Şalterli ve Düz Göstergeli 2 Each mechanical switches and with flat indicator.
SB - MH	2 Adet Mekanik Şalterli ve Yüksek Göstergeli 2 Each mechanical switches and with high indicator.
SB - PB	2 Adet Proximity Şalterli ve Göstergesiz 2 Each proximity switches and without indicator.
SB - PF	2 Adet Proximity Şalterli ve Düz Göstergeli 2 Each proximity switches and with flat indicator.
SB - PH	2 Adet Proximity Şalterli ve Yüksek Göstergeli 2 Each proximity switches and with high indicator.
YT-850	AC-250V/3A, 125V 5A, DC-250V 0.2A, 125V 0.4A, 30V 4A 2 Each mechanical switches and with high indicator.



46

SB - MF



47

SB - MH

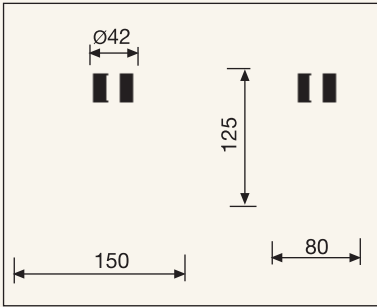

YT-850 Sınır Şalter Kutusu
YT-850 Limit Switch Box



48

- **YT - 2300L** Linear, Smart E / P
- **YT - 2300R** Rotary, Smart E / P
- **YT - 2400L** Linear, Smart E / P
- **YT - 2400R** Rotary, Smart E / P
- **YT - 1000L** Linear, Smart E / P
- **YT - 1000R** Rotary
- **YT - 1000R** Dome Cover, Rotary E/P
- **YT - 1300L** Linear, Smart E / P
- **YT - 1300R** Rotary, Smart E / P
- **YT - 1200L** Linear, Pneumatic
- **YT - 1200R** Rotary, Pneumatic
- **YT - 200** Alüminyum Filtre, Regulator
- **YT - 250** Paslanmaz Çelik Filtre, Regulator
- **YT - 300** Volume Booster
- **PTM - 5VR** Rotary, Position Transmitters
- **PTM - 6VR** Rotary, Position Transmitters

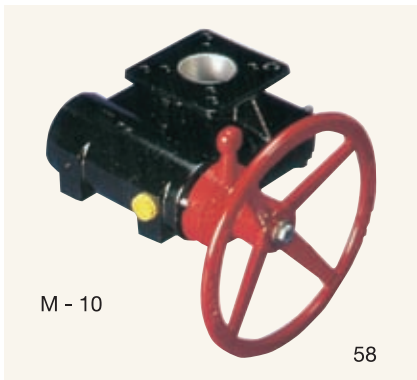
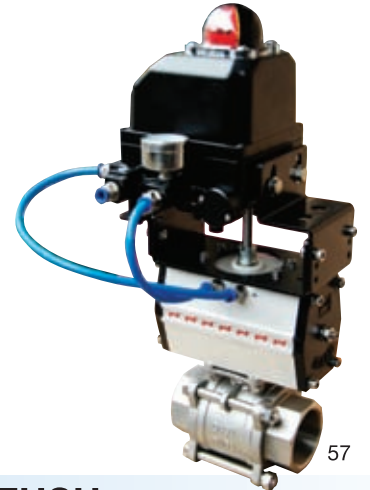

EL KUMANDA İÇİN DİŞLİ KUTUSU MANUAL OVERRIDE

Pnömatik Aktüatör ile vana arasına takılan ve gerektiğinde elle açıp kapamayı sağlayan ünite

Mounted between the Pneumatic Actuator and Valve and used for controlling manually.

Model	Moment
M0 - 10	max. 100 Nm
M0 - 50	max. 500 Nm
M0 - 160	max. 1600 Nm



Elektrik Aktuatör "SA" Serisi / Electric Actuator "SA" Series

- Kelebek, Küresel, Plug Valfler ile 90° dönüş hareketi yapan sistemler için.
- 50 Nm döndürme kuvveti
- On – Off veya oransal çalışma
- IP 68 koruma sınıfı
- AC110 /230 V AC 1 faz (60/50 Hz)
- DC 24 çalışma gerilimi
- For Butterfly, Ball, Plug Valves and quarter turn systems
- 50 Nm moment valve
- On – Off or proportional working
- Normal or ex-proof type
- 110 /220 V AC 1 faz (60/50 Hz)
- DC 24 supply voltage



60a



60



61

Elektrik Aktuatör "NA" Serisi / Electric Actuator "NA" Series

- Kelebek, Küresel, Plug Valfler ile 90° dönüş hareketi yapan sistemler için.
- On – Off veya oransal çalışma
- IP 67
- 110 /220 V AC 1 faz (60/50 Hz)
- 380 /440 V AC 3 faz çalışma gerilimi
- For Butterfly, Ball, Plug Valves and quarter turn systems
- On – Off or proportional working
- IP 67
- 110 /220 V AC 1 faz (60/50 Hz)
- 380 /440 V AC 3 faz supply voltage

- Elektrik Aktüatörlü Kelebek Vanalar
Ölçüler : DN 80 (3").....DN 600 (24")
- Elektrik Aktüatörlü Küresel Vanalar
Ölçüler : DN 40 (1 1/2").....DN 300 (12")
- Electric Actuated Butterfly Valves
Size : DN 80 (3").....DN 600 (24")
- Electric Actuated Ball Valves
Size : DN 40 (1 1/2").....DN 300 (12")



62



63

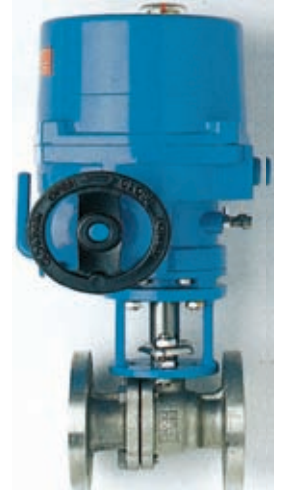

64

Elektrik Aktuatör "RA" Serisi / Electric Actuator "RA" Series (MULTI-TURN)

- Sürgülü, Kelebek, Küresel vanalar için çok turlu sistem
- On – Off veya oransal çalışma
- Normal veya ex-proof
- 220 V AC 60Hz/50 Hz
- 380 /440 V AC 60Hz/50 Hz çalışma gerilimi
- For Gate, Butterfly, Ball Valves multi-turn systems
- On – Off or proportional working
- Normal or ex-proof type
- 220 V AC 60Hz/50 Hz
- 380 /440 V AC 60Hz/20 Hz supply voltage



65



65a



66

Genel Özellikleri

- Üçlü eksantrik diskli dizayn
- Metal oturma yüzeyli
- Basınç : ANSI 150-300-600 900 ve PN 10-16-25-40-64-100
- API 609'ye uygun sıfır sızdırmazlık testi
- Sıcaklık Aralığı : -196 °C'dan +815 °C
- Ölçüler : 2"-72" (DN50 - 1800)
- Açma ve kapamada sürtünmeden bağımsız
- Vakum hatları için uygunluk
- Paslanmaz çelik sızdırmazlık contası ve oturma yüzeyi
- API 609 standardına göre vana mili
- Çelik kaplama, paslanmaz çelik ve özel alaşımlar
- Yangın güvenli, BS 6755 ve API 607

General Characteristics

- Triple eccentric design
- Metal seating
- Pressure: ANSI 150-300-600 900 and PN 10-16-25-40-64-100
- Full bi-directional shut off according API 609
- Temperature range : -196 °C up to +815 °C
- Additional requirements mutual agreement
- Size : 2"-72" (DN50 - 1800) Additional requirements mutual agreement
- Friction free opening and closing
- Vacuum tight
- Laminated seal and seat made of stainless steel
- Anti blow-out shaft API 609
- Steel casting, stainless steel, special alloy
- Fire-safe acc. to BS 6755 and API 607 4th ed. for both flow directions

TRI-CON SERIES



71



72



73



74



75

Model F

Çift Flanşlı
DIN EN 558/F4
Kolay montaj
(DN 80 - 1800)
PN 10-100

Model F

Double Flange
DIN EN 558/F4
Simple mounting
(DN80 - 1800)
PN 10-100

Model S

Flanşsız
3"-72" (DN80 - 1800)
PN 10-100
ANSI 150-600

Model S

Buttweld S1
No Flange tightness
problems
3"-72" (DN80 - 1800)
PN 10-100
ANSI 150-600

Model D/I

Çift Flanşlı
ISO 5752/F16
Kolay montaj
2"-72" (DN50 - 1800)
PN 10-100
ANSI 150-900

Model D/I

Double Flange
ISO 5752/F16
World-wide standard
2"-72" (DN50 - 1800)
PN 10-100
ANSI 150-900

Model B

Çift Flanşlı
ANSI B16.10
Sürgülü vanaların
yerine kullanılır
3"-24" (DN80 - 600)
ANSI 150-600

Model B

Double Flange
ANSI B16.10
Gate valve
replacement
3"-24" (DN80 - 600)
ANSI 150-600

Model A/L

Lug tip
API 609 T2 / DIN EN 558
Kompakt dizayn
2"-36" (DN50 - 900)
PN 10-100
ANSI 150-900

Model A/L

Lugged Type
API 609 T2/ DIN EN 558
Compact design
2"-36" (DN50 - 900)
PN 10-100
ANSI 150-900



KONTROL VANALARI / CONTROL VALVES

- Kontrol Vanaları

- ON/OFF Vanalar
- Pnömatik Aktüatör için Pozisyoner
- IP Çevirici
- Pnömatik Kontrolörler
- Pnömatik Transmitter Kaydediciler
- Kaydedici Kontrolörler
- Fark Basınç Transmitter
- Aksesuarlar

- Control Valves

- ON/OFF Valves
- Positioner for Pneumatic Actuator
- I to P Converters
- Pneumatic Controller
- Pneumatic Transmitter Recorders
- Recording Controllers
- Differential Pressure Transmitter
- Accessories





DEBİ, SEVİYE, BASINÇ ve SICAKLIK ÖLÇME ve KONTROL CİHAZLARI
FLOW, LEVEL, PRESSURE and TEMPERATURE MEASURING and CONTROL INSTRUMENTS



Debimetreler
Flowmeters



Debimetreler
Flowmeters



Debimetreler, Akış Şalterleri
Flowmeters, Flow Switches



Debimetreler
Flowmeters



UNIROTA



Manometreler
Pressure



Basınç Transmitterleri
Pressure Transmitters



Seviye Şalterleri
Level Switches



Seviye Göstergeleri
Level Indicators

KOBOLD MESSRING GMBH Debi, Seviye, Basınç, Sıcaklık, pH ölçme ve kontrol cihazları üreten bir Alman firması olup pek çok ülkede kendi firması ve 110'dan fazla ülkede de temsilciliği bulunmaktadır. Oldukça geniş olan ürün yelpazesi sayesinde müşterilerinin ihtiyacını kolaylıkla karşılayabilmektedir. Geniş AR-GE çalışmaları nedeniyle mevcut ürünlerin kalitesi geliştirilmekte ve her yıl müşteriye yeni ürünler sunulmaktadır.

KOBOLD MESSRING GMBH is manufacturing Flow, Level, Pressure, Temperature and pH measuring and control instruments. It is originated from Germany but has their own companies in many different countries and has distributors more than 110 countries. Through the very large product range, Kobold covers the customer requests very easily. With the purpose of Research and Development department the quality of the instruments increase and new instruments added to program every year.



84
Plastik Debimetre
Plastic Flowmeter



85
Metal Debimetre
Metal Flowmeter



86
Türbin Debimetre
Turbine Flowmeter



87
Türbin Debimetre
Turbine Flowmeter



88
Türbin Debimetre
Turbine Flowmeter

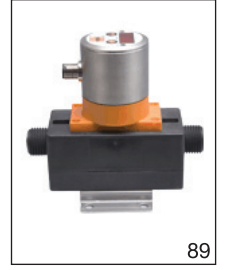

89
Manyetik Debimetre
Magnetic Flowmeter



90
Akış Şalteri
Flow Switch



91
Seviye Şalteri
Level Switch



92
Seviye Şalterleri
Level Switches



93
Seviye Şalteri
Level Switch



94
Seviye Şalteri
Level Switch



95
Seviye Göstergesi
Level Indicator



96
Basınç Transmitteri
Pressure Transmitter



97
Basınç Transmitteri
Pressure Transmitter



98
Basınç Şalteri
Pressure Switch



99
Diyaframlı Manometre
Diaphragm Pressure



100
Diyaframlı Dijital Manometre
Diaphragm Digital Pressure Gauge



101
Dijital Manometre
Digital Pressure Gauge



102
Dijital Termometre
Digital Thermometer



103
İnfrared Termometre
Infrared Thermometer



104
Dijital Gösterge
Digital Indicator



105
Dijital El Termometre
Digital Hand



106
Debimetre
Flowmeter



107
Debi Regülatörü
Flow Regulator



108
Nem Ölçer
Humidity



109
Nem Ölçer
Humidity



110
Dijital Göstergeler
Digital Indicators



111
pH Elektrodu
pH Electrode



112
Bulanıklık Ölçer
Turbidity Meter



113
Dijital Göstergeler
Digital Indicators

Model: PIT+UMF



114

Daldırma Tip Manyetik Akış Ölçer
Magnetic Inductive Flow Meter

Model: DMH



115

Manyetik Akış Ölçer
Magnetic Inductive Flow Meter

Model: TM (Universal)



116

Coriolis Kütle Akış Ölçer
Coriolis Mass Flow Meter

Model: TSK



117

Flap Tip Akış Ölçer
Flap Flow Meter for Liquids

Model: BGN



118

Metal Tip Akış Ölçer
All Metal Variable Area Flow Meter

Model: DOG

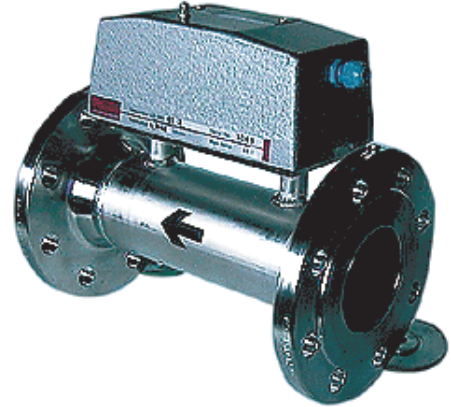

119

Osilatör Tip Akış Ölçer
Oscillation Flow Meter

Model: DVK



120

Kalorimetrik Akış Ölçer
Calorimetric Flow Meter

Model: DVZ



121

Vorteks Tip Akış Ölçer
Vortex Type Flow Meter

Model: DWF



122

Yoğunluk Ölçer
Density Meter



123



124



125



126

Pinch Vana, gövdesi içerisine gönderilen hava ile elastiki contanın kapanması ve gövde içerisindeki hava tahliyesiyle contanın açılması ile akış kontrolü sağlanan pnömatik vana'dır. Kontrol için aktuatör, redüktör gibi harici parçalara ihtiyaç duymaz. Alüminyum, POM, Paslanmaz Çelik gövdeleriyle ve DN10 – DN250 boyut aralığında her türlü kullanımda kendine yer bulmaktadır. Başlıca avantajları arasında hareketli parçalarının olmaması, akışkana karşı düşük direnç, hafif olması, bakım gerektirmemesi, düşük hava tüketimi ve kullanım kolaylığı sayılabilir.

Başlıca kullanıldığı endüstri alanlar

- ✓ Pnömatik taşıyıcı sistemler
- ✓ Çimento, Kireç, Alçı / Silo tanklarında
- ✓ Demir-Çelik / Metal sanayi
- ✓ Seramik / Cam / Plastik endüstrisinde
- ✓ Gıda / İlaç / İçecek sektöründe
- ✓ Vakum konveyör sistemlerinde
- ✓ Dozajlama / Ağırlık sistemlerinde
- ✓ Toz boyama / Kaplama sistemlerinde

The pinch valve is the pneumatic valve which has the flexibility sleeve allows the valve to close droptight around entrapped solids to accomplished by air pressure placed directly on the elastomer sleeve. It does not need any control unit like actuators or reducers .There is variously material and size choosen such as aluminium , POM and stainless steel for body and DN 10-DN 250 for dimension. The primary advantages of the pinch valves is free passage, optimum tightness, low resistance, no leakage, no plugging, low air volume and low weight.

Applications ;

- ✓ Pneumatic conveying systems
- ✓ Cement-/Silo branch
- ✓ Pigments and granulates
- ✓ Ceramics-/glass-/plastic industry
- ✓ Sewage water industry
- ✓ Pharmaceutical-/food industry
- ✓ Vacuum -convertor system
- ✓ Wine industry



pvd

T-GM-BU-VA-YA- Serisi
T-GM-BU-VA-YA Series

CE enosad

T-GM-BU-VA-YA- Serisi SOLENOİD VALFLER
T-GM-BU-VA-YA Series SOLENOID VALVES



pvd

T-PA Serisi
T-PA Series

CE enosad

T-PA Serisi PNÖMATİK AKTÜATÖRLER
T-PA Series PNEUMATIC ACTUATORS

T-PA Serisi PNÖMATİK AKTÜATÖRLÜ VANALAR
T-PA Series PNEUMATIC ACTUATED VALVES



pvd

T-PAT 500 Serisi
T-PAT 500 Series

CE enosad

T-PAT 500 Serisi PATLAÇ VALFLER
T-PAT 500 Series DUST BAG SHAKER VALVES



pvd

T-PVD 700 Serisi
T-PVD 700 Series

CE enosad

T-PVD 700 Serisi PNÖMATİK PİSTONLU VANALAR
T-PVD 700 Series PNEUMATIC PISTON OPERATED VALVES

T-PT 800 Serisi PİSİLİK TUTUCULAR
T-PT 800 Series STRAINERS

Bayii



pvd Proses Vana Donanım San. ve Tic. Ltd. Şti.

Fabrika: Yukarı Dudullu, Şerifali, Divan Sk. No:50, 34775 ÜMRANIYE / İSTANBUL / TURKEY
Tel: +90 216 - 415 65 40 pbx. Fax: +90 216 - 364 22 52 GSM 0532 206 13 48

Mağaza: Necatibey Cd. Karanlık Fırın Sk. No: 11, 34425 KARAKÖY / İSTANBUL / TURKEY
Tel: +90 212 - 245 77 37/38 Fax: +90 212 - 245 77 39 GSM 0532 206 13 49

www.pvd.com.tr e-mail : info@pvd.com.tr