

KAMA®



AD2400
serisi



AD4300
serisi



AY4300
serisi



AY5100
serisi



AY6700
serisi



AMORTİSÖRLÜ Teker Kataloğu



RULET KODLAMA SİSTEMİ

→ CASTOR CODE SYSTEMS

AY ÖN KOD CODE	43 SERİ KODU SERIAL TYPE	02 BAĞLANTI TİPİ FIXATION TYPE	D GÖVDE CİNSİ RIM TYPE	2 SIRT TİPİ TYRE FORM TYPE	0 SIRT MALZEMESİ TYRE MATERIAL	R YATAK TİPİ BEARING TYPE	200 TEKER ÇAPİ (Ømm) WHEEL DIAMETER	F04 FREN SİSTEMİ BREAK TYPE	K İLAVE BİLGİ HANESİ INFORMATION DIGITS	T İLAVE BİLGİ HANESİ INFORMATION DIGITS
AY AMORTİSÖR YATIK ŞEKİLDE	24	01 CIVATA/BOLT 	A POLİMİD 66 POLYAMİDE 66	1 U PROFİLLİ SIRT (F14-MARKET) U PROFILED TREAD	A POLİMİD 66 POLYAMİDE 66	A	100	F04 	Y 	
AD AMORTİSÖR DİK ŞEKİLDE	43	02 TABLA/PLATE 	B İSİYA DAYANIKLI BAKALIT HEAD RESISTANT	2 DERİN RADÜSLÜ (OVAVALI) SIRT TİPİ OVAL TREAD TYPE	B İSİYA DAYANIKLI BAKALIT HEAD-RESISTANT	B BURÇ YATAKLAMASI GÖVDENİN KENDİ PLAIN BEARING	125	F17 	YEŞİL YAY GREEN SPRING	
	51	07 SABİT/MAŞA/FİKED/CASTOR 	C TAKVİYELİ PP REINFORCED THERMOPLASTIC	3 ÜÇ KANALLI SIRT FORMLU(MARKET TİPİ) THREE SPLICED TREAD FORM	C PLASTİK(P.V.C.) PLASTIC(P.V.C.)	C İSİYA DAYANIKLI BURÇ PLAIN BEARING	130	F20 	M 	
	67		D PİK(DÖKÜM) CAST IRON	4 U PROFİLLİ GÖVDEDEN BOMBELİ(F14-MAZİNETİPİ) U PROFILED/BULGED BODY	D PİK(DÖKÜM) CAST IRON	D DEMİR BURÇ PLAIN BEARING	140		K 	
			E	5	E GRİ LASTİK GREY RUBBER	E	150		MAVİ YAY BLUE SPRING	
			F POLİAMİD 6 KÜTÜK POLYAMİDE 6 LOG	6	F POLİAMİD 6 KÜTÜK POLYAMİDE 6 LOG	F	160			
			G	7	G	G	170			
			H	8	H HAVALI LASTİK PNEUMATIC RUBBER	H	180			
			I	9	I	I	200			
			K KAMALON KAMALON		K KAMALON KAMALON	K	220			
			L		L SİYAH LASTİK BLACK RUBBER	L	250			
			M POLİPROPİLEN POLYPROPYLENE		M POLİPROPİLEN POLYPROPYLENE	M DİZME MİSKET BİLYALI YATAKLAMA BALL BEARING	260			
			N TAKVİYELİ PA6		N TAKVİYELİ PA6	N	270			
			O		O DÖKME POLİURETAN CAST POLIURETANE	O	280			
			P POLİAMİD 6 POLYAMİDE 6		P POLİAMİD 6 POLYAMİDE 6	P POLİAMİD BURÇLU YATAKLAMA PLAIN BEARING(POLYAMİDE)	300			
			R AĞIR TİP HEAVY DUTY		R MAVİ LASTİK BLUE RUBBER	R BİLYA RULMANLI YATAKLAMA PRECISION BALL BEARING				
			S SAC STEEL		S YARI HAVALI (DUBLEKS)LASTİK SEMI PNEUMATIC	S MASURALI YATAKLAMA ROLLER BEARING				
			T		T TERMOELASTİK LASTİK TERMOELASTIC RUBBER	T				
			U		U ENJEKSİYON BASKI POLİURETAN INJECTION PRESSURE POLIURETANE	U				
			V		V VULKANİZE LASTİK VULCANIZED RUBBER	V				
			Y		Y AĞIR TİP VULKANİZE LASTİK VULCANIZED RUBBER(HEAVY DUTY)	Y				
			Z ALAŞIMLI ALÜMİNYUM HARD ALUMINIUM		Z	Z				
									SARI YAY YELLOW SPRING	

AD2400 Serisi

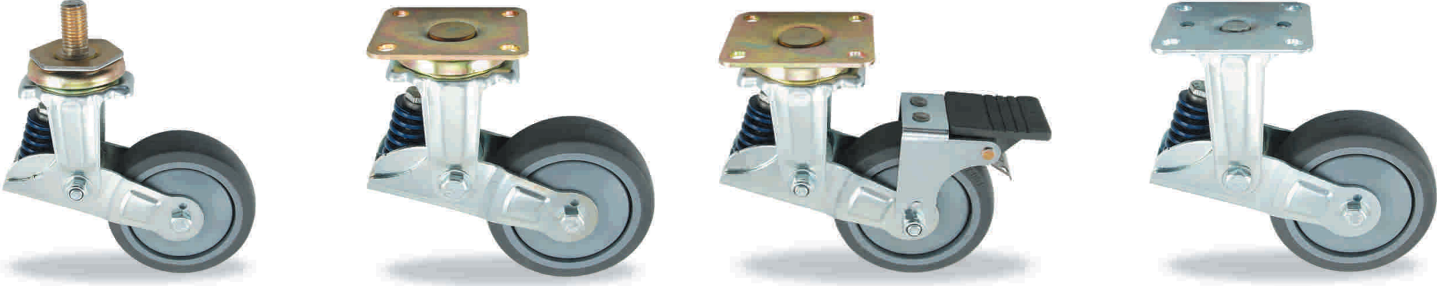

AD2400 Serisi Ruletler

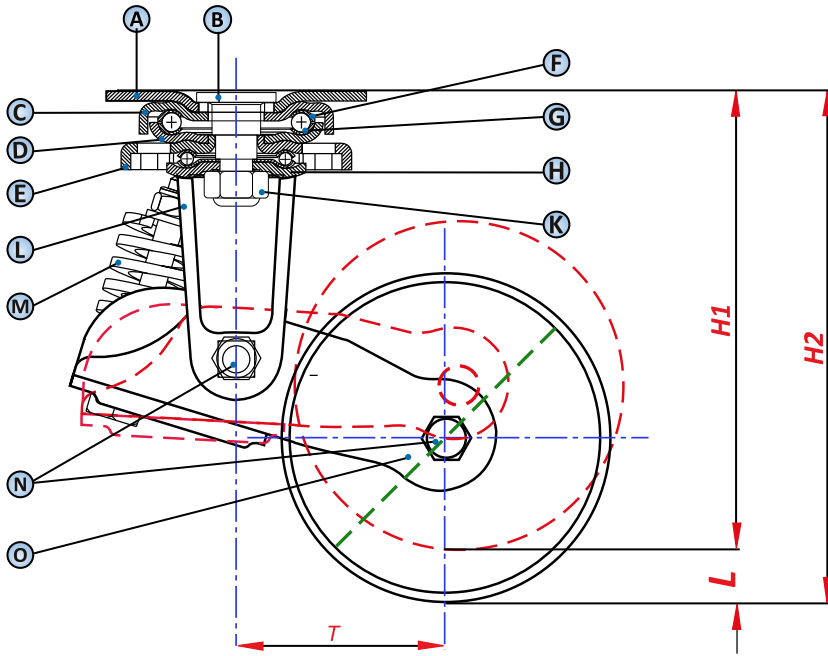

- A** Dikdörtgen, 4 delikli preslerde kesilerek soğuk şekillendirilerek üretilmiş 3mm. kalınlığında beyaz galvaniz kaplamalı sac bağlantı tablası.
- B** Güçlendirilmiş ana yataklama mili (tabla civatası).
- C** Üst bilya yataklama çanağı (ters motaj).
- D** Üst bilya yatağı alt çanağı.
- E** Rulet maşası ana gövde (maşa çatalı).
- F** Üst bilya yataklamasına ait CK60'tan üretilen sert, alt ve üst rulman bilezikleri.
- G** Küresel metal tane bilya alt&üst yatakları.
- H** Alt bilya yataklamasına ait CK60'tan üretilen sert, alt ve üst rulman bilezikleri.
- J** Alt bilya yataklama çanağı.
- K** Ana yataklama mili montaj somunu.
- L** Amortisör strok ayarı somunu.
- M** Amortisör yayı.
- N** Rulet maşası AKS bağlantı milleri.
- O** Amortisörlü rulet maşası mafsalı (ayağı).

AD2400
serisi

kg	KOD NO	mm	mm	mm	mm	mm	mm	mm	mm	mm	mm	YAYIN SON KUVVETİ kg	ÖN GERME KUVVETİ kg	H2 TOPLAM YÜKSEKLİK mm	H1 YÜKLÜ TOPL. YÜKSEKLİK mm	L YAY YOLU mm
90	AD 2401 MLR 100M	100	28		M16	30	64					35	25	155	139	16
90	AD 2401 MLR 100K	100	28		M16	30	64					60	30	155	134	21
90	AD 2401 MLR 100S	100	28		M16	30	64					85	55	155	135	20
100	AD 2401 MLR 125M	125	32		M16	30	75					35	15	180	153	27
100	AD 2401 MLR 125K	125	32		M16	30	75					55	20	180	153	27
100	AD 2401 MLR 125S	125	32		M16	30	75					80	30	180	144	36

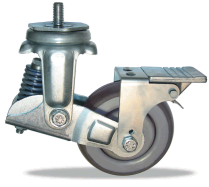

90	AD 2401 MLR 100 F04M	100	28	135	M16	30	64				90	25	155	139	16
90	AD 2401 MLR 100 F04K	100	28	135	M16	30	64				90	30	155	134	21
90	AD 2401 MLR 100 F04S	100	28	135	M16	30	64				90	55	155	135	20
110	AD 2401 MLR 125 F04M	125	32	146	M16	30	75				110	15	180	153	27
100	AD 2401 MLR 125 F04K	125	32	146	M16	30	75				100	20	180	153	27
100	AD 2401 MLR 125 F04S	125	32	146	M16	30	75				100	30	180	144	36

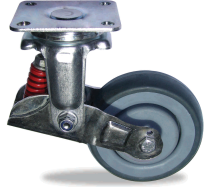

90	AD 2402 MLR 100M	100	28				64	79X70	8.5	60X50	35	25	155	139	16
90	AD 2402 MLR 100K	100	28				64	79X70	8.5	60X50	60	30	155	134	21
90	AD 2402 MLR 100S	100	28				64	79X70	8.5	60X50	85	55	155	135	20
110	AD 2402 MLR 125M	125	32				75	79X70	8.5	60X50	35	15	180	153	27
100	AD 2402 MLR 125K	125	32				75	79X70	8.5	60X50	55	20	180	153	27
100	AD 2402 MLR 125S	125	32				75	79X70	8.5	60X50	80	30	180	144	36

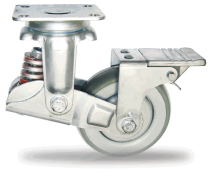

90	AD 2402 MLR 100 F04M	100	28	135			64	79X70	8.5	60X50	35	25	155	139	16
90	AD 2402 MLR 100 F04K	100	28	135			64	79X70	8.5	60X50	60	30	155	134	21
90	AD 2402 MLR 100 F04S	100	28	135			64	79X70	8.5	60X50	85	55	155	135	20
110	AD 2402 MLR 125 F04M	125	32	146			75	79X70	8.5	60X50	35	15	180	153	27
100	AD 2402 MLR 125 F04K	125	32	146			75	79X70	8.5	60X50	55	20	180	153	27
100	AD 2402 MLR 125 F04S	125	32	146			75	79X70	8.5	60X50	80	30	180	144	36

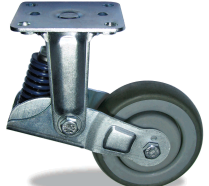

90	AD 2407 MLR 100M	100	28				64	79X70	8.5	60X50	35	25	155	139	16
90	AD 2407 MLR 100K	100	28				64	79X70	8.5	60X50	60	30	155	134	21
90	AD 2407 MLR 100S	100	28				64	79X70	8.5	60X50	85	55	155	135	20
110	AD 2407 MLR 125M	125	32				75	79X70	8.5	60X50	35	15	180	153	27
100	AD 2407 MLR 125K	125	32				75	79X70	8.5	60X50	55	20	180	153	27
100	AD 2407 MLR 125S	125	32				75	79X70	8.5	60X50	80	30	180	144	36

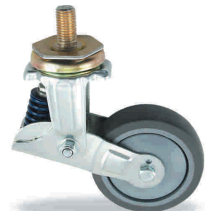

100	AD 2401 MTR 100M	100	32		M16	30	64				35	25	155	139	16
100	AD 2401 MTR 100K	100	32		M16	30	64				60	30	155	134	21
100	AD 2401 MTR 100S	100	32		M16	30	64				85	55	155	135	20
120	AD 2401 MTR 125M	125	32		M16	30	75				35	15	180	153	27
120	AD 2401 MTR 125K	125	32		M16	30	75				55	20	180	153	27
120	AD 2401 MTR 125S	125	32		M16	30	75				80	30	180	144	36



100	AD 2401 MTR 100 F04M	100	32	135	M16	30	64				35	25	155	139	16
100	AD 2401 MTR 100 F04K	100	32	135	M16	30	64				60	30	155	134	21
100	AD 2401 MTR 100 F04S	100	32	135	M16	30	64				85	55	155	135	20
120	AD 2401 MTR 125 F04M	125	32	146	M16	30	75				35	15	180	153	27
120	AD 2401 MTR 125 F04K	125	32	146	M16	30	75				55	20	180	153	27
120	AD 2401 MTR 125 F04S	125	32	146	M16	30	75				80	30	180	144	36



100	AD 2402 MTR 100M	100	32				64	79X70	8.5	60X50	35	25	155	139	16
100	AD 2402 MTR 100K	100	32				64	79X70	8.5	60X50	60	30	155	134	21
100	AD 2402 MTR 100S	100	32				64	79X70	8.5	60X50	85	55	155	135	20
120	AD 2402 MTR 125M	125	32				75	79X70	8.5	60X50	35	15	180	153	27
120	AD 2402 MTR 125K	125	32				75	79X70	8.5	60X50	55	20	180	153	27
120	AD 2402 MTR 125S	125	32				75	79X70	8.5	60X50	80	30	180	144	36

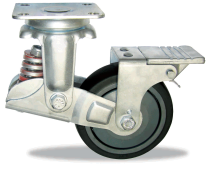

100	AD 2402 MTR 100 F04M	100	32	135				64	79X70	8.5	60X50	35	25	155	139	16
100	AD 2402 MTR 100 F04K	100	32	135				64	79X70	8.5	60X50	60	30	155	134	21
100	AD 2402 MTR 100 F04S	100	32	135				64	79X70	8.5	60X50	85	55	155	135	20
120	AD 2402 MTR 100 F04M	125	32	146				75	79X70	8.5	60X50	35	15	180	153	27
120	AD 2402 MTR 125 F04K	125	32	146				75	79X70	8.5	60X50	55	20	180	153	27
120	AD 2402 MTR 125 F04S	125	32	146				75	79X70	8.5	60X50	80	30	180	144	36



100	AD 2407 MTR 100M	100	32					64	79X70	8.5	60X50	35	25	155	139	16
100	AD 2407 MTR 100K	100	32					64	79X70	8.5	60X50	60	30	155	134	21
100	AD 2407 MTR 100S	100	32					64	79X70	8.5	60X50	85	55	155	135	20
120	AD 2407 MTR 125M	125	32					75	79X70	8.5	60X50	35	15	180	153	27
120	AD 2407 MTR 125K	125	32					75	79X70	8.5	60X50	55	20	180	153	27
120	AD 2407 MTR 125S	125	32					75	79X70	8.5	60X50	80	30	180	144	36

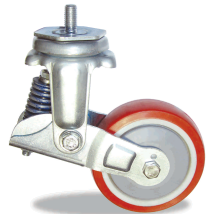

170	AD 2401 PUR 100M	100	32		M16	30	64					35	25	155	139	16
170	AD 2401 PUR 100K	100	32		M16	30	64					60	30	155	134	21
170	AD 2401 PUR 100S	100	32		M16	30	64					85	55	155	135	20
180	AD 2401 PUR 125M	125	32		M16	30	75					35	15	180	153	27
180	AD 2401 PUR 125K	125	32		M16	30	75					55	20	180	153	27
180	AD 2401 PUR 125S	125	32		M16	30	75					80	30	180	144	36

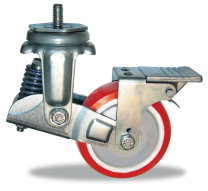

170	AD 2401 PUR 100 F04M	100	32	135	M16	30	64					35	25	155	139	16
170	AD 2401 PUR 100 F04K	100	32	135	M16	30	64					60	30	155	134	21
170	AD 2401 PUR 100 F04S	100	32	135	M16	30	64					85	55	155	135	20
180	AD 2401 PUR 125 F04M	125	32	146	M16	30	75					35	15	180	153	27
180	AD 2401 PUR 125 F04K	125	32	146	M16	30	75					55	20	180	153	27
180	AD 2401 PUR 125 F04S	125	32	146	M16	30	75					80	30	180	144	36

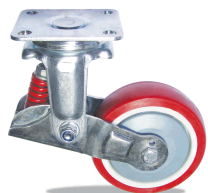

170	AD 2402 PUR 100M	100	32					64	79X70	8.5	60X50	35	25	155	139	16
170	AD 2402 PUR 100K	100	32					64	79X70	8.5	60X50	60	30	155	134	21
170	AD 2402 PUR 100S	100	32					64	79X70	8.5	60X50	85	55	155	135	20
180	AD 2402 PUR 125M	125	32					75	79X70	8.5	60X50	35	15	180	153	27
180	AD 2402 PUR 125K	125	32					75	79X70	8.5	60X50	55	20	180	153	27
180	AD 2402 PUR 125S	125	32					75	79X70	8.5	60X50	80	30	180	144	36

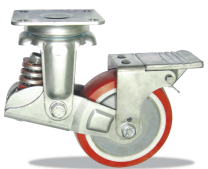

170	AD 2402 PUR 100 F04M	100	32	135				64	79X70	8.5	60X50	35	25	155	139	16
170	AD 2402 PUR 100 F04K	100	32	135				64	79X70	8.5	60X50	60	30	155	134	21
170	AD 2402 PUR 100 F04S	100	32	135				64	79X70	8.5	60X50	85	55	155	135	20
180	AD 2402 PUR 125 F04M	125	32	146				75	79X70	8.5	60X50	35	15	180	153	27
180	AD 2402 PUR 125 F04K	125	32	146				75	79X70	8.5	60X50	55	20	180	153	27
180	AD 2402 PUR 125 F04S	125	32	146				75	79X70	8.5	60X50	80	30	180	144	36

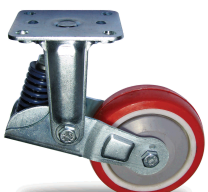

170	AD 2407 PUR 100M	100	32					64	79X70	8.5	60X50	35	25	155	139	16
170	AD 2407 PUR 100K	100	32					64	79X70	8.5	60X50	60	30	155	134	21
170	AD 2407 PUR 100S	100	32					64	79X70	8.5	60X50	85	55	155	135	20
180	AD 2407 PUR 125M	125	32					75	79X70	8.5	60X50	35	15	180	153	27
180	AD 2407 PUR 125K	125	32					75	79X70	8.5	60X50	55	20	180	153	27
180	AD 2407 PUR 125S	125	32					75	79X70	8.5	60X50	80	30	180	144	36

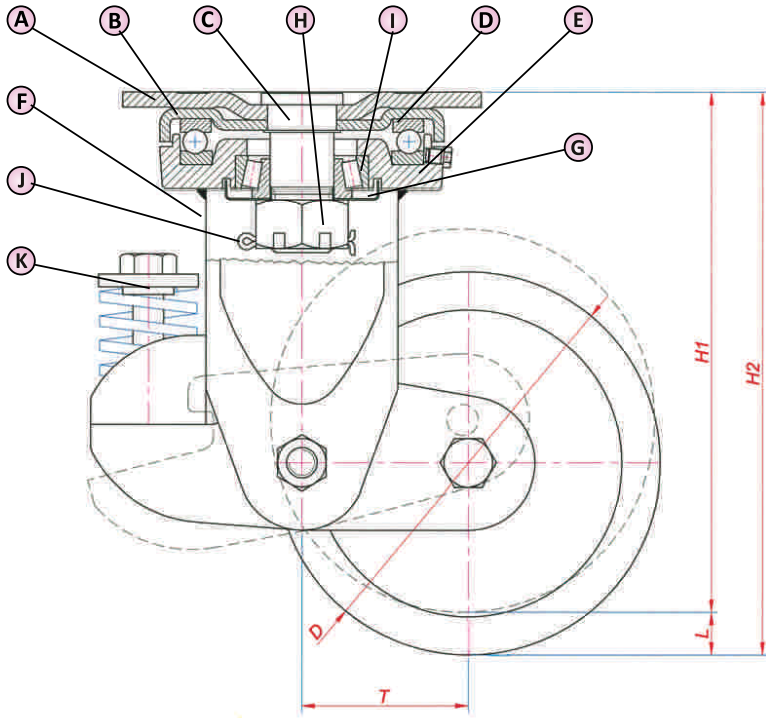

AD4300 Serisi



AD4300 Serisi Ruletler

- A** Hidrolik preste formlanmış 6mm. kalınlığında olan dikdörtgen tabla.
- B** Üst bilya çanağını çepeçevre saran su ve toz ile temasını engelleyen üst bilya kapağı.
- C** Kalın tabla bağlantı civatası.
- D** Emniyetli bir yataklama ve yüksek manevra kabiliyeti sağlayan aksenal kuvvetleri bünyesine alan bute rulman.
- E** Sıcak dövmeden tornalanarak imal edilmiş üst bilya çanağı.
- F** Rulmanların yağlanması için monte edilen gresörlük.
- G** Su-toz gibi aşındırıcı maddelerin bilya yatağına girmesini engelleyen metal toz muhafaza kapağı.
- H** Ayarlanabilir taçlı somun.
- I** Yüksek manevra kabiliyeti sağlayan konik rulman.
- J** Somun emniyetinin sağlanması için monte edilen tespit gupilyası.
- K** Amortisörlü yük ayarı.

AD4300
serisi

	 kg	KOD NO	 mm	 mm	 mm	 mm	 mm	 mm	 mm	 mm	YAYIN SON KUVVETİ kg	ÖN GERME KUVVETİ kg	H2 TOPLAM YÜKSEKLİK mm	H1 YÜKLÜ TOPLAM YÜKSEKLİK mm	L YAY YOLU mm
450		AD 4302 DDR 100Y	100	35		65	140X110	13.5X11	105X80	160	40	177	160	17	
450		AD 4302 DDR 100M	100	35		65	140X110	13.5X11	105X80	300	70	177	160	17	
450		AD 4302 DDR 100K	100	35		65	140X110	13.5X11	105X80	450	80	177	160	17	
450		AD 4302 DDR 100S	100	35		65	140X110	13.5X11	105X80	700	120	177	160	17	
600		AD 4302 DDR 125Y	125	40		65	140X110	13.5X11	105X80	160	40	189.5	172.5	17	
600		AD 4302 DDR 125M	125	40		65	140X110	13.5X11	105X80	300	70	189.5	172.5	17	
600		AD 4302 DDR 125K	125	40		65	140X110	13.5X11	105X80	450	80	189.5	172.5	17	
600		AD 4302 DDR 125S	125	40		65	140X110	13.5X11	105X80	700	120	189.5	172.5	17	
800		AD 4302 DDR 150Y	150	45		65	140X110	13.5X11	105X80	160	50	220	201	18	
800		AD 4302 DDR 150M	150	45		65	140X110	13.5X11	105X80	300	80	220	201	18	
800		AD 4302 DDR 150K	150	45		65	140X110	13.5X11	105X80	450	100	220	201	18	
800		AD 4302 DDR 150S	150	45		65	140X110	13.5X11	105X80	700	120	220	201	18	
1.000		AD 4302 DDR 200Y	200	50		70	140X110	13.5X11	105X80	190	70	275	253	22	
1.000		AD 4302 DDR 200M	200	50		70	140X110	13.5X11	105X80	300	90	275	253	22	
1.000		AD 4302 DDR 200K	200	50		70	140X110	13.5X11	105X80	450	110	275	253	22	
1.000		AD 4302 DDR 200S	200	50		70	140X110	13.5X11	105X80	700	130	275	253	22	



KOD NO



YAYIN SON KUJUVETİ kg

ÖN GERME KUJUVETİ kg

H2 TOPLAM YÜKSEKLİK mm

H1 YÜKLÜ TOPL YÜKSEKLİK mm

L YAY YOLU mm



450	AD 4302 DDR 100 F04Y	100	35	247	65	140X110	13.5X11	105X80	160	40	177	160	17
450	AD 4302 DDR 100 F04M	100	35	247	65	140X110	13.5X11	105X80	300	70	177	160	17
450	AD 4302 DDR 100 F04K	100	35	247	65	140X110	13.5X11	105X80	450	80	177	160	17
450	AD 4302 DDR 100 F04S	100	35	247	65	140X110	13.5X11	105X80	700	120	177	160	17
600	AD 4302 DDR 125 F04Y	125	40	257	65	140X110	13.5X11	105X80	160	40	189.5	172.5	17
600	AD 4302 DDR 125 F04M	125	40	257	65	140X110	13.5X11	105X80	300	70	189.5	172.5	17
600	AD 4302 DDR 125 F04K	125	40	257	65	140X110	13.5X11	105X80	450	80	189.5	172.5	17
600	AD 4302 DDR 125 F04S	125	40	257	65	140X110	13.5X11	105X80	700	120	189.5	172.5	17
800	AD 4302 DDR 150 F04Y	150	45	262	65	140X110	13.5X11	105X80	160	50	220	201	18
800	AD 4302 DDR 150 F04M	150	45	262	65	140X110	13.5X11	105X80	300	80	220	201	18
800	AD 4302 DDR 150 F04K	150	45	262	65	140X110	13.5X11	105X80	450	100	220	201	18
800	AD 4302 DDR 150 F04S	150	45	262	65	140X110	13.5X11	105X80	700	120	220	201	18
1.000	AD 4302 DDR 200 F04Y	200	50	290	70	140X110	13.5X11	105X80	190	70	275	253	22
1.000	AD 4302 DDR 200 F04M	200	50	290	70	140X110	13.5X11	105X80	300	90	275	253	22
1.000	AD 4302 DDR 200 F04K	200	50	290	70	140X110	13.5X11	105X80	450	110	275	253	22
1.000	AD 4302 DDR 200 F04S	200	50	290	70	140X110	13.5X11	105X80	700	130	275	253	22



450	AD 4302 DDR 100 F17Y	100	35	145	65	140X110	13.5X11	105X80	160	40	177	160	17
450	AD 4302 DDR 100 F17M	100	35	145	65	140X110	13.5X11	105X80	300	70	177	160	17
450	AD 4302 DDR 100 F17K	100	35	145	65	140X110	13.5X11	105X80	450	80	177	160	17
450	AD 4302 DDR 100 F17S	100	35	145	65	140X110	13.5X11	105X80	700	120	177	160	17
600	AD 4302 DDR 125 F17Y	125	40	145	65	140X110	13.5X11	105X80	160	40	189.5	172.5	17
600	AD 4302 DDR 125 F17M	125	40	145	65	140X110	13.5X11	105X80	300	70	189.5	172.5	17
600	AD 4302 DDR 125 F17K	125	40	145	65	140X110	13.5X11	105X80	450	80	189.5	172.5	17
600	AD 4302 DDR 125 F17S	125	40	145	65	140X110	13.5X11	105X80	700	120	189.5	172.5	17
800	AD 4302 DDR 150 F17Y	150	45	145	65	140X110	13.5X11	105X80	160	50	220	201	18
800	AD 4302 DDR 150 F17M	150	45	145	65	140X110	13.5X11	105X80	300	80	220	201	18
800	AD 4302 DDR 150 F17K	150	45	145	65	140X110	13.5X11	105X80	450	100	220	201	18
800	AD 4302 DDR 150 F17S	150	45	145	65	140X110	13.5X11	105X80	700	120	220	201	18
1.000	AD 4302 DDR 200 F17Y	200	50	145	70	140X110	13.5X11	105X80	190	70	275	253	22
1.000	AD 4302 DDR 200 F17M	200	50	145	70	140X110	13.5X11	105X80	300	90	275	253	22
1.000	AD 4302 DDR 200 F17K	200	50	145	70	140X110	13.5X11	105X80	450	110	275	253	22
1.000	AD 4302 DDR 200 F17S	200	50	145	70	140X110	13.5X11	105X80	700	130	275	253	22



450	AD 4307 DDR 100Y	100	35		65	140X110	13.5X11	105X80	160	40	177	160	17
450	AD 4307 DDR 100M	100	35		65	140X110	13.5X11	105X80	300	70	177	160	17
450	AD 4307 DDR 100K	100	35		65	140X110	13.5X11	105X80	450	80	177	160	17
450	AD 4307 DDR 100S	100	35		65	140X110	13.5X11	105X80	700	120	177	160	17
600	AD 4307 DDR 125Y	125	40		65	140X110	13.5X11	105X80	160	40	189.5	172.5	17
600	AD 4307 DDR 125M	125	40		65	140X110	13.5X11	105X80	300	70	189.5	172.5	17
600	AD 4307 DDR 125K	125	40		65	140X110	13.5X11	105X80	450	80	189.5	172.5	17
600	AD 4307 DDR 125S	125	40		65	140X110	13.5X11	105X80	700	120	189.5	172.5	17
800	AD 4307 DDR 150Y	150	45		65	140X110	13.5X11	105X80	160	50	220	201	18
800	AD 4307 DDR 150M	150	45		65	140X110	13.5X11	105X80	300	80	220	201	18
800	AD 4307 DDR 150K	150	45		65	140X110	13.5X11	105X80	450	100	220	201	18
800	AD 4307 DDR 150S	150	45		65	140X110	13.5X11	105X80	700	120	220	201	18
1.000	AD 4307 DDR 200Y	200	50		70	140X110	13.5X11	105X80	190	70	275	253	22
1.000	AD 4307 DDR 200M	200	50		70	140X110	13.5X11	105X80	300	90	275	253	22
1.000	AD 4307 DDR 200K	200	50		70	140X110	13.5X11	105X80	450	110	275	253	22
1.000	AD 4307 DDR 200S	200	50		70	140X110	13.5X11	105X80	700	130	275	253	22



	KOD NO	mm	mm	mm	mm	mm	mm	mm	mm	YAYIN SON KUVVETİ kg	ÖN GERME KUVVETİ kg	H2 TOPLAM YÜKSEKLİK mm	H1 YÜKLÜ TOPL YÜKSEKLİK mm	L YAY YOLU mm
450	AD 4302 DOR 100Y	100	35		65	140X110	13.5X11	105X80	160	40	177	160	17	
450	AD 4302 DOR 100M	100	35		65	140X110	13.5X11	105X80	300	70	177	160	17	
450	AD 4302 DOR 100K	100	35		65	140X110	13.5X11	105X80	450	80	177	160	17	
450	AD 4302 DOR 100S	100	35		65	140X110	13.5X11	105X80	700	120	177	160	17	
600	AD 4302 DOR 125Y	125	40		65	140X110	13.5X11	105X80	160	40	189.5	172.5	17	
600	AD 4302 DOR 125M	125	40		65	140X110	13.5X11	105X80	300	70	189.5	172.5	17	
600	AD 4302 DOR 125K	125	40		65	140X110	13.5X11	105X80	450	80	189.5	172.5	17	
600	AD 4302 DOR 125S	125	40		65	140X110	13.5X11	105X80	700	120	189.5	172.5	17	
800	AD 4302 DOR 150Y	150	45		65	140X110	13.5X11	105X80	160	50	220	201	18	
800	AD 4302 DOR 150M	150	45		65	140X110	13.5X11	105X80	300	80	220	201	18	
800	AD 4302 DOR 150K	150	45		65	140X110	13.5X11	105X80	450	100	220	201	18	
800	AD 4302 DOR 150S	150	45		65	140X110	13.5X11	105X80	700	120	220	201	18	
1.200	AD 4302 DOR 200Y	200	50		70	140X110	13.5X11	105X80	190	70	275	253	22	
1.200	AD 4302 DOR 200M	200	50		70	140X110	13.5X11	105X80	300	90	275	253	22	
1.200	AD 4302 DOR 200K	200	50		70	140X110	13.5X11	105X80	450	110	275	253	22	
1.200	AD 4302 DOR 200S	200	50		70	140X110	13.5X11	105X80	700	130	275	253	22	



	KOD NO	mm	mm	mm	mm	mm	mm	mm	mm	YAYIN SON KUVVETİ kg	ÖN GERME KUVVETİ kg	H2 TOPLAM YÜKSEKLİK mm	H1 YÜKLÜ TOPL YÜKSEKLİK mm	L YAY YOLU mm
450	AD 4302 DOR 100 F04Y	100	35	247	65	140X110	13.5X11	105X80	160	40	177	160	17	
450	AD 4302 DOR 100 F04M	100	35	247	65	140X110	13.5X11	105X80	300	70	177	160	17	
450	AD 4302 DOR 100 F04K	100	35	247	65	140X110	13.5X11	105X80	450	80	177	160	17	
450	AD 4302 DOR 100 F04S	100	35	247	65	140X110	13.5X11	105X80	700	120	177	160	17	
600	AD 4302 DOR 125 F04Y	125	40	257	65	140X110	13.5X11	105X80	160	40	189.5	172.5	17	
600	AD 4302 DOR 125 F04M	125	40	257	65	140X110	13.5X11	105X80	300	70	189.5	172.5	17	
600	AD 4302 DOR 125 F04K	125	40	257	65	140X110	13.5X11	105X80	450	80	189.5	172.5	17	
600	AD 4302 DOR 125 F04S	125	40	257	65	140X110	13.5X11	105X80	700	120	189.5	172.5	17	
800	AD 4302 DOR 150 F04Y	150	45	262	65	140X110	13.5X11	105X80	160	50	220	201	18	
800	AD 4302 DOR 150 F04M	150	45	262	65	140X110	13.5X11	105X80	300	80	220	201	18	
800	AD 4302 DOR 150 F04K	150	45	262	65	140X110	13.5X11	105X80	450	100	220	201	18	
800	AD 4302 DOR 150 F04S	150	45	262	65	140X110	13.5X11	105X80	700	120	220	201	18	
1.200	AD 4302 DOR 200 F04Y	200	50	290	70	140X110	13.5X11	105X80	190	70	275	253	22	
1.200	AD 4302 DOR 200 F04M	200	50	290	70	140X110	13.5X11	105X80	300	90	275	253	22	
1.200	AD 4302 DOR 200 F04K	200	50	290	70	140X110	13.5X11	105X80	450	110	275	253	22	
1.200	AD 4302 DOR 200 F04S	200	50	290	70	140X110	13.5X11	105X80	700	130	275	253	22	



	KOD NO	mm	mm	mm	mm	mm	mm	mm	mm	YAYIN SON KUVVETİ kg	ÖN GERME KUVVETİ kg	H2 TOPLAM YÜKSEKLİK mm	H1 YÜKLÜ TOPL YÜKSEKLİK mm	L YAY YOLU mm
450	AD 4302 DOR 100 F17Y	100	35	145	65	140X110	13.5X11	105X80	160	40	177	160	17	
450	AD 4302 DOR 100 F17M	100	35	145	65	140X110	13.5X11	105X80	300	70	177	160	17	
450	AD 4302 DOR 100 F17K	100	35	145	65	140X110	13.5X11	105X80	450	80	177	160	17	
450	AD 4302 DOR 100 F17S	100	35	145	65	140X110	13.5X11	105X80	700	120	177	160	17	
600	AD 4302 DOR 125 F17Y	125	40	145	65	140X110	13.5X11	105X80	160	40	189.5	172.5	17	
600	AD 4302 DOR 125 F17M	125	40	145	65	140X110	13.5X11	105X80	300	70	189.5	172.5	17	
600	AD 4302 DOR 125 F17K	125	40	145	65	140X110	13.5X11	105X80	450	80	189.5	172.5	17	
600	AD 4302 DOR 125 F17S	125	40	145	65	140X110	13.5X11	105X80	700	120	189.5	172.5	17	
800	AD 4302 DOR 150 F17Y	150	45	145	65	140X110	13.5X11	105X80	160	50	220	201	18	
800	AD 4302 DOR 150 F17M	150	45	145	65	140X110	13.5X11	105X80	300	80	220	201	18	
800	AD 4302 DOR 150 F17K	150	45	145	65	140X110	13.5X11	105X80	450	100	220	201	18	
800	AD 4302 DOR 150 F17S	150	45	145	65	140X110	13.5X11	105X80	700	120	220	201	18	
1.200	AD 4302 DOR 200 F17Y	200	50	145	70	140X110	13.5X11	105X80	190	70	275	253	22	
1.200	AD 4302 DOR 200 F17M	200	50	145	70	140X110	13.5X11	105X80	300	90	275	253	22	
1.200	AD 4302 DOR 200 F17K	200	50	145	70	140X110	13.5X11	105X80	450	110	275	253	22	
1.200	AD 4302 DOR 200 F17S	200	50	145	70	140X110	13.5X11	105X80	700	130	275	253	22	



		mm	mm	mm	mm	mm	mm	mm	mm	kg	kg	mm	mm	mm
450	AD 4307 DOR 100Y	100	35		65	140X110	13.5X11	105X80	160	40	177	160	17	
450	AD 4307 DOR 100M	100	35		65	140X110	13.5X11	105X80	300	70	177	160	17	
450	AD 4307 DOR 100K	100	35		65	140X110	13.5X11	105X80	450	80	177	160	17	
450	AD 4307 DOR 100S	100	35		65	140X110	13.5X11	105X80	700	120	177	160	17	
600	AD 4307 DOR 125Y	125	40		65	140X110	13.5X11	105X80	160	40	189.5	172.5	17	
600	AD 4307 DOR 125M	125	40		65	140X110	13.5X11	105X80	300	70	189.5	172.5	17	
600	AD 4307 DOR 125K	125	40		65	140X110	13.5X11	105X80	450	80	189.5	172.5	17	
600	AD 4307 DOR 125S	125	40		65	140X110	13.5X11	105X80	700	120	189.5	172.5	17	
800	AD 4307 DOR 150Y	150	45		65	140X110	13.5X11	105X80	160	50	220	201	18	
800	AD 4307 DOR 150M	150	45		65	140X110	13.5X11	105X80	300	80	220	201	18	
800	AD 4307 DOR 150K	150	45		65	140X110	13.5X11	105X80	450	100	220	201	18	
800	AD 4307 DOR 150S	150	45		65	140X110	13.5X11	105X80	700	120	220	201	18	
1.200	AD 4307 DOR 200Y	200	50		70	140X110	13.5X11	105X80	190	70	275	253	22	
1.200	AD 4307 DOR 200M	200	50		70	140X110	13.5X11	105X80	300	90	275	253	22	
1.200	AD 4307 DOR 200K	200	50		70	140X110	13.5X11	105X80	450	110	275	253	22	
1.200	AD 4307 DOR 200S	200	50		70	140X110	13.5X11	105X80	700	130	275	253	22	

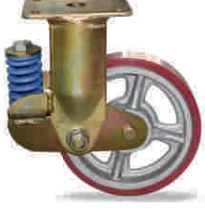

		mm	mm	mm	mm	mm	mm	mm	mm	mm	mm	mm	mm
450	AD 4302 D2OR 100Y	100	35		65	140X110	13.5X11	105X80	160	40	177	160	17
450	AD 4302 D2OR 100M	100	35		65	140X110	13.5X11	105X80	300	70	177	160	17
450	AD 4302 D2OR 100K	100	35		65	140X110	13.5X11	105X80	450	80	177	160	17
450	AD 4302 D2OR 100S	100	35		65	140X110	13.5X11	105X80	700	120	177	160	17
600	AD 4302 D2OR 125Y	125	40		65	140X110	13.5X11	105X80	160	40	189.5	172.5	17
600	AD 4302 D2OR 125M	125	40		65	140X110	13.5X11	105X80	300	70	189.5	172.5	17
600	AD 4302 D2OR 125K	125	40		65	140X110	13.5X11	105X80	450	80	189.5	172.5	17
600	AD 4302 D2OR 125S	125	40		65	140X110	13.5X11	105X80	700	120	189.5	172.5	17
800	AD 4302 D2OR 150Y	150	45		65	140X110	13.5X11	105X80	160	50	220	201	18
800	AD 4302 D2OR 150M	150	45		65	140X110	13.5X11	105X80	300	80	220	201	18
800	AD 4302 D2OR 150K	150	45		65	140X110	13.5X11	105X80	450	100	220	201	18
800	AD 4302 D2OR 150S	150	45		65	140X110	13.5X11	105X80	700	120	220	201	18
1.200	AD 4302 D2OR 200Y	200	50		70	140X110	13.5X11	105X80	190	70	275	253	22
1.200	AD 4302 D2OR 200M	200	50		70	140X110	13.5X11	105X80	300	90	275	253	22
1.200	AD 4302 D2OR 200K	200	50		70	140X110	13.5X11	105X80	450	110	275	253	22
1.200	AD 4302 D2OR 200S	200	50		70	140X110	13.5X11	105X80	700	130	275	253	22



		mm	mm	mm	mm	mm	mm	mm	mm	mm	mm	mm	mm
450	AD 4302 D2OR 100 F04Y	100	35	247	65	140X110	13.5X11	105X80	160	40	177	160	17
450	AD 4302 D2OR 100 F04M	100	35	247	65	140X110	13.5X11	105X80	300	70	177	160	17
450	AD 4302 D2OR 100 F04K	100	35	247	65	140X110	13.5X11	105X80	450	80	177	160	17
450	AD 4302 D2OR 100 F04S	100	35	247	65	140X110	13.5X11	105X80	700	120	177	160	17
600	AD 4302 D2OR 125 F04Y	125	40	257	65	140X110	13.5X11	105X80	160	40	189.5	172.5	17
600	AD 4302 D2OR 125 F04M	125	40	257	65	140X110	13.5X11	105X80	300	70	189.5	172.5	17
600	AD 4302 D2OR 125 F04K	125	40	257	65	140X110	13.5X11	105X80	450	80	189.5	172.5	17
600	AD 4302 D2OR 125 F04S	125	40	257	65	140X110	13.5X11	105X80	700	120	189.5	172.5	17
800	AD 4302 D2OR 150 F04Y	150	45	262	65	140X110	13.5X11	105X80	160	50	220	201	18
800	AD 4302 D2OR 150 F04M	150	45	262	65	140X110	13.5X11	105X80	300	80	220	201	18
800	AD 4302 D2OR 150 F04K	150	45	262	65	140X110	13.5X11	105X80	450	100	220	201	18
800	AD 4302 D2OR 150 F04S	150	45	262	65	140X110	13.5X11	105X80	700	120	220	201	18
1.200	AD 4302 D2OR 200 F04Y	200	50	290	70	140X110	13.5X11	105X80	190	70	275	253	22
1.200	AD 4302 D2OR 200 F04M	200	50	290	70	140X110	13.5X11	105X80	300	90	275	253	22
1.200	AD 4302 D2OR 200 F04K	200	50	290	70	140X110	13.5X11	105X80	450	110	275	253	22
1.200	AD 4302 D2OR 200 F04S	200	50	290	70	140X110	13.5X11	105X80	700	130	275	253	22





450	AD 4302 D2OR 100 F17Y	100	35	145	65	140X110	13.5X11	105X80	160	40	177	160	17
450	AD 4302 D2OR 100 F17M	100	35	145	65	140X110	13.5X11	105X80	300	70	177	160	17
450	AD 4302 D2OR 100 F17K	100	35	145	65	140X110	13.5X11	105X80	450	80	177	160	17
450	AD 4302 D2OR 100 F17S	100	35	145	65	140X110	13.5X11	105X80	700	120	177	160	17
600	AD 4302 D2OR 125 F17Y	125	40	145	65	140X110	13.5X11	105X80	160	40	189.5	172.5	17
600	AD 4302 D2OR 125 F17M	125	40	145	65	140X110	13.5X11	105X80	300	70	189.5	172.5	17
600	AD 4302 D2OR 125 F17K	125	40	145	65	140X110	13.5X11	105X80	450	80	189.5	172.5	17
600	AD 4302 D2OR 125 F17S	125	40	145	65	140X110	13.5X11	105X80	700	120	189.5	172.5	17
800	AD 4302 D2OR 150 F17Y	150	45	145	65	140X110	13.5X11	105X80	160	50	220	201	18
800	AD 4302 D2OR 150 F17M	150	45	145	65	140X110	13.5X11	105X80	300	80	220	201	18
800	AD 4302 D2OR 150 F17K	150	45	145	65	140X110	13.5X11	105X80	450	100	220	201	18
800	AD 4302 D2OR 150 F17S	150	45	145	65	140X110	13.5X11	105X80	700	120	220	201	18
1.200	AD 4302 D2OR 200 F17Y	200	50	145	70	140X110	13.5X11	105X80	190	70	275	253	22
1.200	AD 4302 D2OR 200 F17M	200	50	145	70	140X110	13.5X11	105X80	300	90	275	253	22
1.200	AD 4302 D2OR 200 F17K	200	50	145	70	140X110	13.5X11	105X80	450	110	275	253	22
1.200	AD 4302 D2OR 200 F17S	200	50	145	70	140X110	13.5X11	105X80	700	130	275	253	22



450	AD 4307 D2OR 100Y	100	35		65	140X110	13.5X11	105X80	160	40	177	160	17
450	AD 4307 D2OR 100M	100	35		65	140X110	13.5X11	105X80	300	70	177	160	17
450	AD 4307 D2OR 100K	100	35		65	140X110	13.5X11	105X80	450	80	177	160	17
450	AD 4307 D2OR 100S	100	35		65	140X110	13.5X11	105X80	700	120	177	160	17
600	AD 4307 D2OR 125Y	125	40		65	140X110	13.5X11	105X80	160	40	189.5	172.5	17
600	AD 4307 D2OR 125M	125	40		65	140X110	13.5X11	105X80	300	70	189.5	172.5	17
600	AD 4307 D2OR 125K	125	40		65	140X110	13.5X11	105X80	450	80	189.5	172.5	17
600	AD 4307 D2OR 125S	125	40		65	140X110	13.5X11	105X80	700	120	189.5	172.5	17
800	AD 4307 D2OR 150Y	150	45		65	140X110	13.5X11	105X80	160	50	220	201	18
800	AD 4307 D2OR 150M	150	45		65	140X110	13.5X11	105X80	300	80	220	201	18
800	AD 4307 D2OR 150K	150	45		65	140X110	13.5X11	105X80	450	100	220	201	18
800	AD 4307 D2OR 150S	150	45		65	140X110	13.5X11	105X80	700	120	220	201	18
1.200	AD 4307 D2OR 200Y	200	50		70	140X110	13.5X11	105X80	190	70	275	253	22
1.200	AD 4307 D2OR 200M	200	50		70	140X110	13.5X11	105X80	300	90	275	253	22
1.200	AD 4307 D2OR 200K	200	50		70	140X110	13.5X11	105X80	450	110	275	253	22
1.200	AD 4307 D2OR 200S	200	50		70	140X110	13.5X11	105X80	700	130	275	253	22



140	AD 4302 D2OR 100Y	100	35		65	140X110	13.5X11	105X80	160	40	177	160	17
140	AD 4302 D2OR 100M	100	35		65	140X110	13.5X11	105X80	300	70	177	160	17
140	AD 4302 D2OR 100K	100	35		65	140X110	13.5X11	105X80	450	80	177	160	17
140	AD 4302 D2OR 100S	100	35		65	140X110	13.5X11	105X80	700	120	177	160	17
180	AD 4302 D2OR 125Y	125	40		65	140X110	13.5X11	105X80	160	40	189.5	172.5	17
180	AD 4302 D2OR 125M	125	40		65	140X110	13.5X11	105X80	300	70	189.5	172.5	17
180	AD 4302 D2OR 125K	125	40		65	140X110	13.5X11	105X80	450	80	189.5	172.5	17
180	AD 4302 D2OR 125S	125	40		65	140X110	13.5X11	105X80	700	120	189.5	172.5	17
200	AD 4302 D2OR 150Y	150	45		65	140X110	13.5X11	105X80	160	50	220	201	18
200	AD 4302 D2OR 150M	150	45		65	140X110	13.5X11	105X80	300	80	220	201	18
200	AD 4302 D2OR 150K	150	45		65	140X110	13.5X11	105X80	450	100	220	201	18
200	AD 4302 D2OR 150S	150	45		65	140X110	13.5X11	105X80	700	120	220	201	18
320	AD 4302 D2OR 200Y	200	50		70	140X110	13.5X11	105X80	190	70	275	253	22
320	AD 4302 D2OR 200M	200	50		70	140X110	13.5X11	105X80	300	90	275	253	22
320	AD 4302 D2OR 200K	200	50		70	140X110	13.5X11	105X80	450	110	275	253	22
320	AD 4302 D2OR 200S	200	50		70	140X110	13.5X11	105X80	700	130	275	253	22



	KOD NO	mm	mm	mm	mm	mm	mm	mm	mm	YAYIN SON KUJUVETİ kg	ÖN GERME KUJUVETİ kg	H2 TOPLAM YÜKSEKLİK mm	H1 YÜKLÜ TOPL YÜKSEKLİK mm	L YAY YOLU mm
140	AD 4302 DYP 100 F04Y	100	35	247	65	140X110	13.5X11	105X80	160	40	177	160	17	
140	AD 4302 DYP 100 F04M	100	35	247	65	140X110	13.5X11	105X80	300	70	177	160	17	
140	AD 4302 DYP 100 F04K	100	35	247	65	140X110	13.5X11	105X80	450	80	177	160	17	
140	AD 4302 DYP 100 F04S	100	35	247	65	140X110	13.5X11	105X80	700	120	177	160	17	
180	AD 4302 DYP 125 F04Y	125	40	257	65	140X110	13.5X11	105X80	160	40	189.5	172.5	17	
180	AD 4302 DYP 125 F04M	125	40	257	65	140X110	13.5X11	105X80	300	70	189.5	172.5	17	
180	AD 4302 DYP 125 F04K	125	40	257	65	140X110	13.5X11	105X80	450	80	189.5	172.5	17	
180	AD 4302 DYP 125 F04S	125	40	257	65	140X110	13.5X11	105X80	700	120	189.5	172.5	17	
200	AD 4302 DYP 150 F04Y	150	45	262	65	140X110	13.5X11	105X80	160	50	220	201	18	
200	AD 4302 DYP 150 F04M	150	45	262	65	140X110	13.5X11	105X80	300	80	220	201	18	
200	AD 4302 DYP 150 F04K	150	45	262	65	140X110	13.5X11	105X80	450	100	220	201	18	
200	AD 4302 DYP 150 F04S	150	45	262	65	140X110	13.5X11	105X80	700	120	220	201	18	
320	AD 4302 DYP 200 F04Y	200	50	290	70	140X110	13.5X11	105X80	190	70	275	253	22	
320	AD 4302 DYP 200 F04M	200	50	290	70	140X110	13.5X11	105X80	300	90	275	253	22	
320	AD 4302 DYP 200 F04K	200	50	290	70	140X110	13.5X11	105X80	450	110	275	253	22	
320	AD 4302 DYP 200 F04S	200	50	290	70	140X110	13.5X11	105X80	700	130	275	253	22	



	KOD NO	mm	mm	mm	mm	mm	mm	mm	mm	YAYIN SON KUJUVETİ kg	ÖN GERME KUJUVETİ kg	H2 TOPLAM YÜKSEKLİK mm	H1 YÜKLÜ TOPL YÜKSEKLİK mm	L YAY YOLU mm
140	AD 4302 DYP 100 F17Y	100	35	145	65	140X110	13.5X11	105X80	160	40	177	160	17	
140	AD 4302 DYP 100 F17M	100	35	145	65	140X110	13.5X11	105X80	300	70	177	160	17	
140	AD 4302 DYP 100 F17K	100	35	145	65	140X110	13.5X11	105X80	450	80	177	160	17	
140	AD 4302 DYP 100 F17S	100	35	145	65	140X110	13.5X11	105X80	700	120	177	160	17	
180	AD 4302 DYP 125 F17Y	125	40	145	65	140X110	13.5X11	105X80	160	40	189.5	172.5	17	
180	AD 4302 DYP 125 F17M	125	40	145	65	140X110	13.5X11	105X80	300	70	189.5	172.5	17	
180	AD 4302 DYP 125 F17K	125	40	145	65	140X110	13.5X11	105X80	450	80	189.5	172.5	17	
180	AD 4302 DYP 125 F17S	125	40	145	65	140X110	13.5X11	105X80	700	120	189.5	172.5	17	
200	AD 4302 DYP 150 F17Y	150	45	145	65	140X110	13.5X11	105X80	160	50	220	201	18	
200	AD 4302 DYP 150 F17M	150	45	145	65	140X110	13.5X11	105X80	300	80	220	201	18	
200	AD 4302 DYP 150 F17K	150	45	145	65	140X110	13.5X11	105X80	450	100	220	201	18	
200	AD 4302 DYP 150 F17S	150	45	145	65	140X110	13.5X11	105X80	700	120	220	201	18	
320	AD 4302 DYP 200 F17Y	200	50	145	70	140X110	13.5X11	105X80	190	70	275	253	22	
320	AD 4302 DYP 200 F17M	200	50	145	70	140X110	13.5X11	105X80	300	90	275	253	22	
320	AD 4302 DYP 200 F17K	200	50	145	70	140X110	13.5X11	105X80	450	110	275	253	22	
320	AD 4302 DYP 200 F17S	200	50	145	70	140X110	13.5X11	105X80	700	130	275	253	22	



	KOD NO	mm	mm	mm	mm	mm	mm	mm	mm	YAYIN SON KUJUVETİ kg	ÖN GERME KUJUVETİ kg	H2 TOPLAM YÜKSEKLİK mm	H1 YÜKLÜ TOPL YÜKSEKLİK mm	L YAY YOLU mm
140	AD 4307 DYP 100Y	100	35		65	140X110	13.5X11	105X80	160	40	177	160	17	
140	AD 4307 DYP 100M	100	35		65	140X110	13.5X11	105X80	300	70	177	160	17	
140	AD 4307 DYP 100K	100	35		65	140X110	13.5X11	105X80	450	80	177	160	17	
140	AD 4307 DYP 100S	100	35		65	140X110	13.5X11	105X80	700	120	177	160	17	
180	AD 4307 DYP 125Y	125	40		65	140X110	13.5X11	105X80	160	40	189.5	172.5	17	
180	AD 4307 DYP 125M	125	40		65	140X110	13.5X11	105X80	300	70	189.5	172.5	17	
180	AD 4307 DYP 125K	125	40		65	140X110	13.5X11	105X80	450	80	189.5	172.5	17	
180	AD 4307 DYP 125S	125	40		65	140X110	13.5X11	105X80	700	120	189.5	172.5	17	
200	AD 4307 DYP 150Y	150	45		65	140X110	13.5X11	105X80	160	50	220	201	18	
200	AD 4307 DYP 150M	150	45		65	140X110	13.5X11	105X80	300	80	220	201	18	
200	AD 4307 DYP 150K	150	45		65	140X110	13.5X11	105X80	450	100	220	201	18	
200	AD 4307 DYP 150S	150	45		65	140X110	13.5X11	105X80	700	120	220	201	18	
320	AD 4307 DYP 200Y	200	50		70	140X110	13.5X11	105X80	190	70	275	253	22	
320	AD 4307 DYP 200M	200	50		70	140X110	13.5X11	105X80	300	90	275	253	22	
320	AD 4307 DYP 200K	200	50		70	140X110	13.5X11	105X80	450	110	275	253	22	
320	AD 4307 DYP 200S	200	50		70	140X110	13.5X11	105X80	700	130	275	253	22	



700	AD 4302 KOR 150Y	150	50		65	140X110	13.5X11	105X80	160	50	219	201	18
700	AD 4302 KOR 150M	150	50		65	140X110	13.5X11	105X80	300	80	219	201	18
700	AD 4302 KOR 150K	150	50		65	140X110	13.5X11	105X80	450	100	219	201	18
700	AD 4302 KOR 150S	150	50		65	140X110	13.5X11	105X80	700	120	219	201	18
1000	AD 4302 KOR 200Y	200	50		70	140X110	13.5X11	105X80	190	70	275	253	22
1000	AD 4302 KOR 200M	200	50		70	140X110	13.5X11	105X80	300	90	275	253	22
1000	AD 4302 KOR 200K	200	50		70	140X110	13.5X11	105X80	450	110	275	253	22
1000	AD 4302 KOR 200S	200	50		70	140X110	13.5X11	105X80	700	130	275	253	22



700	AD 4302 KOR 150 F04Y	150	50	262	65	140X110	13.5X11	105X80	160	50	219	201	18
700	AD 4302 KOR 150 F04M	150	50	262	65	140X110	13.5X11	105X80	300	80	219	201	18
700	AD 4302 KOR 150 F04K	150	50	262	65	140X110	13.5X11	105X80	450	100	219	201	18
700	AD 4302 KOR 150 F04S	150	50	262	65	140X110	13.5X11	105X80	700	120	219	201	18
1000	AD 4302 KOR 200 F04Y	200	50	290	70	140X110	13.5X11	105X80	190	70	275	253	22
1000	AD 4302 KOR 200 F04M	200	50	290	70	140X110	13.5X11	105X80	300	90	275	253	22
1000	AD 4302 KOR 200 F04K	200	50	290	70	140X110	13.5X11	105X80	450	110	275	253	22
1000	AD 4302 KOR 200 F04S	200	50	290	70	140X110	13.5X11	105X80	700	130	275	253	22



700	AD 4302 KOR 150 F17Y	150	50	145	65	140X110	13.5X11	105X80	160	50	219	201	18
700	AD 4302 KOR 150 F17M	150	50	145	65	140X110	13.5X11	105X80	300	80	219	201	18
700	AD 4302 KOR 150 F17K	150	50	145	65	140X110	13.5X11	105X80	450	100	219	201	18
700	AD 4302 KOR 150 F17S	150	50	145	65	140X110	13.5X11	105X80	700	120	219	201	18
1000	AD 4302 KOR 200 F17Y	200	50	145	70	140X110	13.5X11	105X80	190	70	275	253	22
1000	AD 4302 KOR 200 F17M	200	50	145	70	140X110	13.5X11	105X80	300	90	275	253	22
1000	AD 4302 KOR 200 F17K	200	50	145	70	140X110	13.5X11	105X80	450	110	275	253	22
1000	AD 4302 KOR 200 F17S	200	50	145	70	140X110	13.5X11	105X80	700	130	275	253	22



700	AD 4307 KOR 150Y	150	50		65	140X110	13.5X11	105X80	160	50	219	201	18
700	AD 4307 KOR 150M	150	50		65	140X110	13.5X11	105X80	300	80	219	201	18
700	AD 4307 KOR 150K	150	50		65	140X110	13.5X11	105X80	450	100	219	201	18
700	AD 4307 KOR 150S	150	50		65	140X110	13.5X11	105X80	700	120	219	201	18
1000	AD 4307 KOR 200Y	200	50		70	140X110	13.5X11	105X80	190	70	275	253	22
1000	AD 4307 KOR 200M	200	50		70	140X110	13.5X11	105X80	300	90	275	253	22
1000	AD 4307 KOR 200K	200	50		70	140X110	13.5X11	105X80	450	110	275	253	22
1000	AD 4307 KOR 200S	200	50		70	140X110	13.5X11	105X80	700	130	275	253	22



1000	AD 4302 K2OR 200Y	200	50		70	140X110	13.5X11	105X80	190	70	275	253	22
1000	AD 4302 K2OR 200M	200	50		70	140X110	13.5X11	105X80	300	90	275	253	22
1000	AD 4302 K2OR 200K	200	50		70	140X110	13.5X11	105X80	450	110	275	253	22
1000	AD 4302 K2OR 200S	200	50		70	140X110	13.5X11	105X80	700	130	275	253	22



1000	AD 4302 K2OR 200 F04Y	200	50	290	70	140X110	13.5X11	105X80	190	70	275	253	22
1000	AD 4302 K2OR 200 F04M	200	50	290	70	140X110	13.5X11	105X80	300	90	275	253	22
1000	AD 4302 K2OR 200 F04K	200	50	290	70	140X110	13.5X11	105X80	450	110	275	253	22
1000	AD 4302 K2OR 200 F04S	200	50	290	70	140X110	13.5X11	105X80	700	130	275	253	22



1000	AD 4302 K2OR 200 F17Y	200	50	145	70	140X110	13.5X11	105X80	190	70	275	253	22
1000	AD 4302 K2OR 200 F17M	200	50	145	70	140X110	13.5X11	105X80	300	90	275	253	22
1000	AD 4302 K2OR 200 F17K	200	50	145	70	140X110	13.5X11	105X80	450	110	275	253	22
1000	AD 4302 K2OR 200 F17S	200	50	145	70	140X110	13.5X11	105X80	700	130	275	253	22



1000	AD 4307 K2OR 200Y	200	50		70	140X110	13.5X11	105X80	190	70	275	253	22
1000	AD 4307 K2OR 200M	200	50		70	140X110	13.5X11	105X80	300	90	275	253	22
1000	AD 4307 K2OR 200K	200	50		70	140X110	13.5X11	105X80	450	110	275	253	22
1000	AD 4307 K2OR 200S	200	50		70	140X110	13.5X11	105X80	700	130	275	253	22



160	AD 4302 PUR 100Y	100	35		65	140X110	13.5X11	105X80	160	40	177	160	17
160	AD 4302 PUR 100M	100	35		65	140X110	13.5X11	105X80	300	70	177	160	17
160	AD 4302 PUR 100K	100	35		65	140X110	13.5X11	105X80	450	80	177	160	17
160	AD 4302 PUR 100S	100	35		65	140X110	13.5X11	105X80	700	120	177	160	17
250	AD 4302 PUR 125Y	125	40		65	140X110	13.5X11	105X80	160	40	189.5	172.5	17
250	AD 4302 PUR 125M	125	40		65	140X110	13.5X11	105X80	300	70	189.5	172.5	17
250	AD 4302 PUR 125K	125	40		65	140X110	13.5X11	105X80	450	80	189.5	172.5	17
250	AD 4302 PUR 125S	125	40		65	140X110	13.5X11	105X80	700	120	189.5	172.5	17
400	AD 4302 PUR 150Y	150	45		65	140X110	13.5X11	105X80	160	50	220	201	18
400	AD 4302 PUR 150M	150	45		65	140X110	13.5X11	105X80	300	80	220	201	18
400	AD 4302 PUR 150K	150	45		65	140X110	13.5X11	105X80	450	100	220	201	18
400	AD 4302 PUR 150S	150	45		65	140X110	13.5X11	105X80	700	120	220	201	18
600	AD 4302 PUR 200Y	200	50		70	140X110	13.5X11	105X80	190	70	275	253	22
600	AD 4302 PUR 200M	200	50		70	140X110	13.5X11	105X80	300	90	275	253	22
600	AD 4302 PUR 200K	200	50		70	140X110	13.5X11	105X80	450	110	275	253	22
600	AD 4302 PUR 200S	200	50		70	140X110	13.5X11	105X80	700	130	275	253	22



160	AD 4302 PUR 100 F04Y	100	35	247	65	140X110	13.5X11	105X80	160	40	177	160	17
160	AD 4302 PUR 100 F04M	100	35	247	65	140X110	13.5X11	105X80	300	70	177	160	17
160	AD 4302 PUR 100 F04K	100	35	247	65	140X110	13.5X11	105X80	450	80	177	160	17
160	AD 4302 PUR 100 F04S	100	35	247	65	140X110	13.5X11	105X80	700	120	177	160	17
250	AD 4302 PUR 125 F04Y	125	40	257	65	140X110	13.5X11	105X80	160	40	189.5	172.5	17
250	AD 4302 PUR 125 F04M	125	40	257	65	140X110	13.5X11	105X80	300	70	189.5	172.5	17
250	AD 4302 PUR 125 F04K	125	40	257	65	140X110	13.5X11	105X80	450	80	189.5	172.5	17
250	AD 4302 PUR 125 F04S	125	40	257	65	140X110	13.5X11	105X80	700	120	189.5	172.5	17
400	AD 4302 PUR 150 F04Y	150	45	262	65	140X110	13.5X11	105X80	160	50	220	201	18
400	AD 4302 PUR 150 F04M	150	45	262	65	140X110	13.5X11	105X80	300	80	220	201	18
400	AD 4302 PUR 150 F04K	150	45	262	65	140X110	13.5X11	105X80	450	100	220	201	18
400	AD 4302 PUR 150 F04S	150	45	262	65	140X110	13.5X11	105X80	700	120	220	201	18
600	AD 4302 PUR 200 F04Y	200	50	290	70	140X110	13.5X11	105X80	190	70	275	253	22
600	AD 4302 PUR 200 F04M	200	50	290	70	140X110	13.5X11	105X80	300	90	275	253	22
600	AD 4302 PUR 200 F04K	200	50	290	70	140X110	13.5X11	105X80	450	110	275	253	22
600	AD 4302 PUR 200 F04S	200	50	290	70	140X110	13.5X11	105X80	700	130	275	253	22



160	AD 4302 PUR 100 F17Y	100	35	145	65	140X110	13.5X11	105X80	160	40	177	160	17
160	AD 4302 PUR 100 F17M	100	35	145	65	140X110	13.5X11	105X80	300	70	177	160	17
160	AD 4302 PUR 100 F17K	100	35	145	65	140X110	13.5X11	105X80	450	80	177	160	17
160	AD 4302 PUR 100 F17S	100	35	145	65	140X110	13.5X11	105X80	700	120	177	160	17
250	AD 4302 PUR 125 F17Y	125	40	145	65	140X110	13.5X11	105X80	160	40	189.5	172.5	17
250	AD 4302 PUR 125 F17M	125	40	145	65	140X110	13.5X11	105X80	300	70	189.5	172.5	17
250	AD 4302 PUR 125 F17K	125	40	145	65	140X110	13.5X11	105X80	450	80	189.5	172.5	17
250	AD 4302 PUR 125 F17S	125	40	145	65	140X110	13.5X11	105X80	700	120	189.5	172.5	17
400	AD 4302 PUR 150 F17Y	150	45	145	65	140X110	13.5X11	105X80	160	50	220	201	18
400	AD 4302 PUR 150 F17M	150	45	145	65	140X110	13.5X11	105X80	300	80	220	201	18
400	AD 4302 PUR 150 F17K	150	45	145	65	140X110	13.5X11	105X80	450	100	220	201	18
400	AD 4302 PUR 150 F17S	150	45	145	65	140X110	13.5X11	105X80	700	120	220	201	18
600	AD 4302 PUR 200 F17Y	200	50	145	70	140X110	13.5X11	105X80	190	70	275	253	22
600	AD 4302 PUR 200 F17M	200	50	145	70	140X110	13.5X11	105X80	300	90	275	253	22
600	AD 4302 PUR 200 F17K	200	50	145	70	140X110	13.5X11	105X80	450	110	275	253	22
600	AD 4302 PUR 200 F17S	200	50	145	70	140X110	13.5X11	105X80	700	130	275	253	22



		mm	mm	mm	mm	mm	mm	mm	mm	kg	kg	mm	mm	mm
400	AD 4307 PUR 100Y	100	35		65	140X110	13.5X11	105X80	160	40	177	160	17	
400	AD 4307 PUR 100M	100	35		65	140X110	13.5X11	105X80	300	70	177	160	17	
400	AD 4307 PUR 100K	100	35		65	140X110	13.5X11	105X80	450	80	177	160	17	
400	AD 4307 PUR 100S	100	35		65	140X110	13.5X11	105X80	700	120	177	160	17	
500	AD 4307 PUR 125Y	125	40		65	140X110	13.5X11	105X80	160	40	189.5	172.5	17	
500	AD 4307 PUR 125M	125	40		65	140X110	13.5X11	105X80	300	70	189.5	172.5	17	
500	AD 4307 PUR 125K	125	40		65	140X110	13.5X11	105X80	450	80	189.5	172.5	17	
500	AD 4307 PUR 125S	125	40		65	140X110	13.5X11	105X80	700	120	189.5	172.5	17	
400	AD 4307 PUR 150Y	150	45		65	140X110	13.5X11	105X80	160	50	220	201	18	
400	AD 4307 PUR 150M	150	45		65	140X110	13.5X11	105X80	300	80	220	201	18	
400	AD 4307 PUR 150K	150	45		65	140X110	13.5X11	105X80	450	100	220	201	18	
400	AD 4307 PUR 150S	150	45		65	140X110	13.5X11	105X80	700	120	220	201	18	
600	AD 4307 PUR 200Y	200	50		70	140X110	13.5X11	105X80	190	70	275	253	22	
600	AD 4307 PUR 200M	200	50		70	140X110	13.5X11	105X80	300	90	275	253	22	
600	AD 4307 PUR 200K	200	50		70	140X110	13.5X11	105X80	450	110	275	253	22	
600	AD 4307 PUR 200S	200	50		70	140X110	13.5X11	105X80	700	130	275	253	22	



		mm	mm	mm	mm	mm	mm	mm	mm	kg	kg	mm	mm	mm
120	AD 4302 PYR 100Y	100	35		65	140X110	13.5X11	105X80	160	40	177	160	17	
120	AD 4302 PYR 100M	100	35		65	140X110	13.5X11	105X80	300	70	177	160	17	
120	AD 4302 PYR 100K	100	35		65	140X110	13.5X11	105X80	450	80	177	160	17	
120	AD 4302 PYR 100S	100	35		65	140X110	13.5X11	105X80	700	120	177	160	17	
150	AD 4302 PYR 125Y	125	40		65	140X110	13.5X11	105X80	160	40	189.5	172.5	17	
150	AD 4302 PYR 125M	125	40		65	140X110	13.5X11	105X80	300	70	189.5	172.5	17	
150	AD 4302 PYR 125K	125	40		65	140X110	13.5X11	105X80	450	80	189.5	172.5	17	
150	AD 4302 PYR 125S	125	40		65	140X110	13.5X11	105X80	700	120	189.5	172.5	17	
180	AD 4302 PYR 150Y	150	45		65	140X110	13.5X11	105X80	160	50	220	201	18	
180	AD 4302 PYR 150M	150	45		65	140X110	13.5X11	105X80	300	80	220	201	18	
180	AD 4302 PYR 150K	150	45		65	140X110	13.5X11	105X80	450	100	220	201	18	
180	AD 4302 PYR 150S	150	45		65	140X110	13.5X11	105X80	700	120	220	201	18	
300	AD 4302 PYR 200Y	200	50		70	140X110	13.5X11	105X80	190	70	275	253	22	
300	AD 4302 PYR 200M	200	50		70	140X110	13.5X11	105X80	300	90	275	253	22	
300	AD 4302 PYR 200K	200	50		70	140X110	13.5X11	105X80	450	110	275	253	22	
300	AD 4302 PYR 200S	200	50		70	140X110	13.5X11	105X80	700	130	275	253	22	



		mm	mm	mm	mm	mm	mm	mm	mm	kg	kg	mm	mm	mm
120	AD 4302 PYR 100 F04Y	100	35	247	65	140X110	13.5X11	105X80	160	40	177	160	17	
120	AD 4302 PYR 100 F04M	100	35	247	65	140X110	13.5X11	105X80	300	70	177	160	17	
120	AD 4302 PYR 100 F04K	100	35	247	65	140X110	13.5X11	105X80	450	80	177	160	17	
120	AD 4302 PYR 100 F04S	100	35	247	65	140X110	13.5X11	105X80	700	120	177	160	17	
150	AD 4302 PYR 125 F04Y	125	40	247	65	140X110	13.5X11	105X80	160	40	189.5	172.5	17	
150	AD 4302 PYR 125 F04M	125	40	247	65	140X110	13.5X11	105X80	300	70	189.5	172.5	17	
150	AD 4302 PYR 125 F04K	125	40	247	65	140X110	13.5X11	105X80	450	80	189.5	172.5	17	
150	AD 4302 PYR 125 F04S	125	40	247	65	140X110	13.5X11	105X80	700	120	189.5	172.5	17	
180	AD 4302 PYR 150 F04Y	150	45	247	65	140X110	13.5X11	105X80	160	50	220	201	18	
180	AD 4302 PYR 150 F04M	150	45	247	65	140X110	13.5X11	105X80	300	80	220	201	18	
180	AD 4302 PYR 150 F04K	150	45	247	65	140X110	13.5X11	105X80	450	100	220	201	18	
180	AD 4302 PYR 150 F04S	150	45	247	65	140X110	13.5X11	105X80	700	120	220	201	18	
300	AD 4302 PYR 200 F04Y	200	50	247	70	140X110	13.5X11	105X80	190	70	275	253	22	
300	AD 4302 PYR 200 F04M	200	50	247	70	140X110	13.5X11	105X80	300	90	275	253	22	
300	AD 4302 PYR 200 F04K	200	50	247	70	140X110	13.5X11	105X80	450	110	275	253	22	
300	AD 4302 PYR 200 F04S	200	50	247	70	140X110	13.5X11	105X80	700	130	275	253	22	





	KOD NO	mm	mm	mm	mm	mm	mm	mm	mm	YAYIN SON KUJUVETİ kg	ÖN GERME KUJUVETİ kg	H2 TOPLAM YÜKSEKLİK mm	H1 YÜKLÜ TOPL YÜKSEKLİK mm	L YAY YOLU mm
120	AD 4302 PYR 100 F17Y	100	35	145	65	140X110	13.5X11	105X80	160	40	177	160	17	
120	AD 4302 PYR 100 F17M	100	35	145	65	140X110	13.5X11	105X80	300	70	177	160	17	
120	AD 4302 PYR 100 F17K	100	35	145	65	140X110	13.5X11	105X80	450	80	177	160	17	
120	AD 4302 PYR 100 F17S	100	35	145	65	140X110	13.5X11	105X80	700	120	177	160	17	
150	AD 4302 PYR 125 F17Y	125	40	145	65	140X110	13.5X11	105X80	160	40	189.5	172.5	17	
150	AD 4302 PYR 125 F17M	125	40	145	65	140X110	13.5X11	105X80	300	70	189.5	172.5	17	
150	AD 4302 PYR 125 F17K	125	40	145	65	140X110	13.5X11	105X80	450	80	189.5	172.5	17	
150	AD 4302 PYR 125 F17S	125	40	145	65	140X110	13.5X11	105X80	700	120	189.5	172.5	17	
180	AD 4302 PYR 150 F17Y	150	45	145	65	140X110	13.5X11	105X80	160	50	220	201	18	
180	AD 4302 PYR 150 F17M	150	45	145	65	140X110	13.5X11	105X80	300	80	220	201	18	
180	AD 4302 PYR 150 F17K	150	45	145	65	140X110	13.5X11	105X80	450	100	220	201	18	
180	AD 4302 PYR 150 F17S	150	45	145	65	140X110	13.5X11	105X80	700	120	220	201	18	
300	AD 4302 PYR 200 F17Y	200	50	145	70	140X110	13.5X11	105X80	190	70	275	253	22	
300	AD 4302 PYR 200 F17M	200	50	145	70	140X110	13.5X11	105X80	300	90	275	253	22	
300	AD 4302 PYR 200 F17K	200	50	145	70	140X110	13.5X11	105X80	450	110	275	253	22	
300	AD 4302 PYR 200 F17S	200	50	145	70	140X110	13.5X11	105X80	700	130	275	253	22	



	KOD NO	mm	mm	mm	mm	mm	mm	mm	mm	YAYIN SON KUJUVETİ kg	ÖN GERME KUJUVETİ kg	H2 TOPLAM YÜKSEKLİK mm	H1 YÜKLÜ TOPL YÜKSEKLİK mm	L YAY YOLU mm
120	AD 4307 PYR 100Y	100	35		65	140X110	13.5X11	105X80	160	40	177	160	17	
120	AD 4307 PYR 100M	100	35		65	140X110	13.5X11	105X80	300	70	177	160	17	
120	AD 4307 PYR 100K	100	35		65	140X110	13.5X11	105X80	450	80	177	160	17	
120	AD 4307 PYR 100S	100	35		65	140X110	13.5X11	105X80	700	120	177	160	17	
150	AD 4307 PYR 125Y	125	40		65	140X110	13.5X11	105X80	160	40	189.5	172.5	17	
150	AD 4307 PYR 125M	125	40		65	140X110	13.5X11	105X80	300	70	189.5	172.5	17	
150	AD 4307 PYR 125K	125	40		65	140X110	13.5X11	105X80	450	80	189.5	172.5	17	
150	AD 4307 PYR 125S	125	40		65	140X110	13.5X11	105X80	700	120	189.5	172.5	17	
180	AD 4307 PYR 150Y	150	45		65	140X110	13.5X11	105X80	160	50	220	201	18	
180	AD 4307 PYR 150M	150	45		65	140X110	13.5X11	105X80	300	80	220	201	18	
180	AD 4307 PYR 150K	150	45		65	140X110	13.5X11	105X80	450	100	220	201	18	
180	AD 4307 PYR 150S	150	45		65	140X110	13.5X11	105X80	700	120	220	201	18	
300	AD 4307 PYR 200Y	200	50		70	140X110	13.5X11	105X80	190	70	275	253	22	
300	AD 4307 PYR 200M	200	50		70	140X110	13.5X11	105X80	300	90	275	253	22	
300	AD 4307 PYR 200K	200	50		70	140X110	13.5X11	105X80	450	110	275	253	22	
300	AD 4307 PYR 200S	200	50		70	140X110	13.5X11	105X80	700	130	275	253	22	



	KOD NO	mm	mm	mm	mm	mm	mm	mm	mm	YAYIN SON KUJUVETİ kg	ÖN GERME KUJUVETİ kg	H2 TOPLAM YÜKSEKLİK mm	H1 YÜKLÜ TOPL YÜKSEKLİK mm	L YAY YOLU mm
400	AD 4302 RPR 100Y	100	35		65	140X110	13.5X11	105X80	160	40	177	160	17	
400	AD 4302 RPR 100M	100	35		65	140X110	13.5X11	105X80	300	70	177	160	17	
400	AD 4302 RPR 100K	100	35		65	140X110	13.5X11	105X80	450	80	177	160	17	
400	AD 4302 RPR 100S	100	35		65	140X110	13.5X11	105X80	700	120	177	160	17	
500	AD 4302 RPR 125Y	125	40		65	140X110	13.5X11	105X80	160	40	189.5	172.5	17	
500	AD 4302 RPR 125M	125	40		65	140X110	13.5X11	105X80	300	70	189.5	172.5	17	
500	AD 4302 RPR 125K	125	40		65	140X110	13.5X11	105X80	450	80	189.5	172.5	17	
500	AD 4302 RPR 125S	125	40		65	140X110	13.5X11	105X80	700	120	189.5	172.5	17	
600	AD 4302 RPR 150Y	150	45		65	140X110	13.5X11	105X80	160	50	220	201	18	
600	AD 4302 RPR 150M	150	45		65	140X110	13.5X11	105X80	300	80	220	201	18	
600	AD 4302 RPR 150K	150	45		65	140X110	13.5X11	105X80	450	100	220	201	18	
600	AD 4302 RPR 150S	150	45		65	140X110	13.5X11	105X80	700	120	220	201	18	
900	AD 4302 RPR 200Y	200	50		70	140X110	13.5X11	105X80	190	70	275	253	22	
900	AD 4302 RPR 200M	200	50		70	140X110	13.5X11	105X80	300	90	275	253	22	
900	AD 4302 RPR 200K	200	50		70	140X110	13.5X11	105X80	450	110	275	253	22	
900	AD 4302 RPR 200S	200	50		70	140X110	13.5X11	105X80	700	130	275	253	22	



400	AD 4302 RPR 100 F04Y	100	35	247	65	140X110	13.5X11	105X80	160	40	177	160	17	
400	AD 4302 RPR 100 F04M	100	35	247	65	140X110	13.5X11	105X80	300	70	177	160	17	
400	AD 4302 RPR 100 F04K	100	35	247	65	140X110	13.5X11	105X80	450	80	177	160	17	
400	AD 4302 RPR 100 F04S	100	35	247	65	140X110	13.5X11	105X80	700	120	177	160	17	
500	AD 4302 RPR 125 F04Y	125	40	257	65	140X110	13.5X11	105X80	160	40	189.5	172.5	17	
500	AD 4302 RPR 125 F04M	125	40	257	65	140X110	13.5X11	105X80	300	70	189.5	172.5	17	
500	AD 4302 RPR 125 F04K	125	40	257	65	140X110	13.5X11	105X80	450	80	189.5	172.5	17	
500	AD 4302 RPR 125 F04S	125	40	257	65	140X110	13.5X11	105X80	700	120	189.5	172.5	17	
600	AD 4302 RPR 150 F04Y	150	45	262	65	140X110	13.5X11	105X80	160	50	220	201	18	
600	AD 4302 RPR 150 F04M	150	45	262	65	140X110	13.5X11	105X80	300	80	220	201	18	
600	AD 4302 RPR 150 F04K	150	45	262	65	140X110	13.5X11	105X80	450	100	220	201	18	
600	AD 4302 RPR 150 F04S	150	45	262	65	140X110	13.5X11	105X80	700	120	220	201	18	
900	AD 4302 RPR 200 F04Y	200	50	290	70	140X110	13.5X11	105X80	190	70	275	253	22	
900	AD 4302 RPR 200 F04M	200	50	290	70	140X110	13.5X11	105X80	300	90	275	253	22	
900	AD 4302 RPR 200 F04K	200	50	290	70	140X110	13.5X11	105X80	450	110	275	253	22	
900	AD 4302 RPR 200 F04S	200	50	290	70	140X110	13.5X11	105X80	700	130	275	253	22	



400	AD 4302 RPR 100 F17Y	100	35	145	65	140X110	13.5X11	105X80	160	40	177	160	17	
400	AD 4302 RPR 100 F17M	100	35	145	65	140X110	13.5X11	105X80	300	70	177	160	17	
400	AD 4302 RPR 100 F17K	100	35	145	65	140X110	13.5X11	105X80	450	80	177	160	17	
400	AD 4302 RPR 100 F17S	100	35	145	65	140X110	13.5X11	105X80	700	120	177	160	17	
500	AD 4302 RPR 125 F17Y	125	40	145	65	140X110	13.5X11	105X80	160	40	189.5	172.5	17	
500	AD 4302 RPR 125 F17M	125	40	145	65	140X110	13.5X11	105X80	300	70	189.5	172.5	17	
500	AD 4302 RPR 125 F17K	125	40	145	65	140X110	13.5X11	105X80	450	80	189.5	172.5	17	
500	AD 4302 RPR 125 F17S	125	40	145	65	140X110	13.5X11	105X80	700	120	189.5	172.5	17	
600	AD 4302 RPR 150 F17Y	150	45	145	65	140X110	13.5X11	105X80	160	50	220	201	18	
600	AD 4302 RPR 150 F17M	150	45	145	65	140X110	13.5X11	105X80	300	80	220	201	18	
600	AD 4302 RPR 150 F17K	150	45	145	65	140X110	13.5X11	105X80	450	100	220	201	18	
600	AD 4302 RPR 150 F17S	150	45	145	65	140X110	13.5X11	105X80	700	120	220	201	18	
900	AD 4302 RPR 200 F17Y	200	50	145	70	140X110	13.5X11	105X80	190	70	275	253	22	
900	AD 4302 RPR 200 F17M	200	50	145	70	140X110	13.5X11	105X80	300	90	275	253	22	
900	AD 4302 RPR 200 F17K	200	50	145	70	140X110	13.5X11	105X80	450	110	275	253	22	
900	AD 4302 RPR 200 F17S	200	50	145	70	140X110	13.5X11	105X80	700	130	275	253	22	



400	AD 4307 RPR 100Y	100	35		65	140X110	13.5X11	105X80	160	40	177	160	17	
400	AD 4307 RPR 100M	100	35		65	140X110	13.5X11	105X80	300	70	177	160	17	
400	AD 4307 RPR 100K	100	35		65	140X110	13.5X11	105X80	450	80	177	160	17	
400	AD 4307 RPR 100S	100	35		65	140X110	13.5X11	105X80	700	120	177	160	17	
500	AD 4307 RPR 125Y	125	40		65	140X110	13.5X11	105X80	160	40	189.5	172.5	17	
500	AD 4307 RPR 125M	125	40		65	140X110	13.5X11	105X80	300	70	189.5	172.5	17	
500	AD 4307 RPR 125K	125	40		65	140X110	13.5X11	105X80	450	80	189.5	172.5	17	
500	AD 4307 RPR 125S	125	40		65	140X110	13.5X11	105X80	700	120	189.5	172.5	17	
600	AD 4307 RPR 150Y	150	45		65	140X110	13.5X11	105X80	160	50	220	201	18	
600	AD 4307 RPR 150M	150	45		65	140X110	13.5X11	105X80	300	80	220	201	18	
600	AD 4307 RPR 150K	150	45		65	140X110	13.5X11	105X80	450	100	220	201	18	
600	AD 4307 RPR 150S	150	45		65	140X110	13.5X11	105X80	700	120	220	201	18	
900	AD 4307 RPR 200Y	200	50		70	140X110	13.5X11	105X80	190	70	275	253	22	
900	AD 4307 RPR 200M	200	50		70	140X110	13.5X11	105X80	300	90	275	253	22	
900	AD 4307 RPR 200K	200	50		70	140X110	13.5X11	105X80	450	110	275	253	22	
900	AD 4307 RPR 200S	200	50		70	140X110	13.5X11	105X80	700	130	275	253	22	





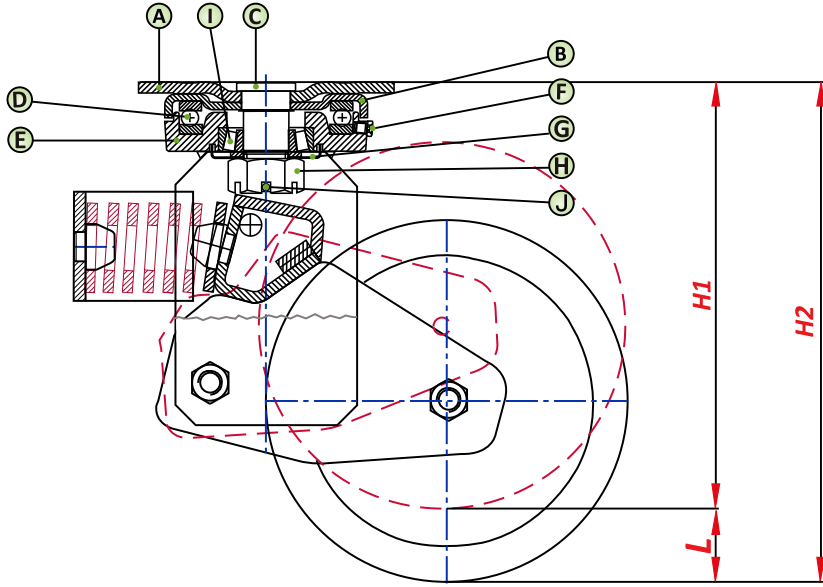











AY4300 Serisi



AY4300 Serisi Ruletler

- A** Hidrolik preste formlanmış 6mm. kalınlığında olan dikdörtgen tabla.
- B** Üst bilya çanağını çepeçevre saran su ve toz ile temasını engelleyen üst bilya kapağı.
- C** Kalın tabla bağlantı civatası.
- D** Emniyetli bir yataklama ve yüksek manevra kabiliyeti sağlayan aksenal kuvvetleri bünyesine alan büte rulman.
- E** Sıcak dövmeden hassas tormalanarak imal edilmiş üst bilya çanağı.
- F** Rulmanların yağlanması için monte edilen gresörlük.
- G** Su-toz gibi aşındırıcı maddelerin bilya yatağına girmesini engelleyen metal toz muhafaza kapağı.
- H** Ayarlanabilir taçlı somun.
- I** Yüksek manevra kabiliyeti sağlayan konik rulman.
- J** Somun emniyetinin sağlanması amacı için monte edilen tespit gupilyası.

AY4300
serisi

	 kg	KOD NO	 mm	 mm	 mm	 mm	 mm	 mm	 mm	 mm	 mm	 mm	 mm	 mm	 mm	 mm
1.000		AY 4302 DDR 200Y	200	50		100	140x110	13.5X11	105X80	200	30	275	223	52		
1.000		AY 4302 DDR 200M	200	50		100	140x110	13.5X11	105X80	300	40	275	230	45		
1.000		AY 4302 DDR 200K	200	50		100	140x110	13.5X11	105X80	450	60	275	237	38		
1.000		AY 4302 DDR 200S	200	50		100	140x110	13.5X11	105X80	600	70	275	245	30		
1.400		AY 4302 DDR 250Y	250	50		120	140x110	13.5X11	105X80	300	40	320	265	45		
1.400		AY 4302 DDR 250M	250	50		120	140x110	13.5X11	105X80	450	60	320	273	47		
1.400		AY 4302 DDR 250K	250	50		120	140x110	13.5X11	105X80	750	100	320	280	40		
1.400		AY 4302 DDR 250S	250	50		120	140x110	13.5X11	105X80	1000	120	320	287	33		



1.000	AY 4302 DDR 200 F04Y	200	50	297	100	140x110	13.5X11	105X80	200	30	275	223	52
1.000	AY 4302 DDR 200 F04M	200	50	297	100	140x110	13.5X11	105X80	300	40	275	230	45
1.000	AY 4302 DDR 200 F04K	200	50	297	100	140x110	13.5X11	105X80	450	60	275	237	38
1.000	AY 4302 DDR 200 F04S	200	50	297	100	140x110	13.5X11	105X80	600	70	275	245	30
1.400	AY 4302 DDR 250 F04Y	250	50		120	140x110	13.5X11	105X80	300	40	320	265	45
1.400	AY 4302 DDR 250 F04M	250	50		120	140x110	13.5X11	105X80	450	60	320	273	47
1.400	AY 4302 DDR 250 F04K	250	50		120	140x110	13.5X11	105X80	750	100	320	280	40
1.400	AY 4302 DDR 250 F04S	250	50		120	140x110	13.5X11	105X80	1000	120	320	287	33



1.000	AY 4302 DDR 200 F17Y	200	50	145	100	140x110	13.5X11	105X80	200	30	275	223	52
1.000	AY 4302 DDR 200 F17M	200	50	145	100	140x110	13.5X11	105X80	300	40	275	230	45
1.000	AY 4302 DDR 200 F17K	200	50	145	100	140x110	13.5X11	105X80	450	60	275	237	38
1.000	AY 4302 DDR 200 F17S	200	50	145	100	140x110	13.5X11	105X80	600	70	275	245	30
1.400	AY 4302 DDR 250 F17Y	250	50	145	120	140x110	13.5X11	105X80	300	40	320	265	45
1.400	AY 4302 DDR 250 F17M	250	50	145	120	140x110	13.5X11	105X80	450	60	320	273	47
1.400	AY 4302 DDR 250 F17K	250	50	145	120	140x110	13.5X11	105X80	750	100	320	280	40
1.400	AY 4302 DDR 250 F17S	250	50	145	120	140x110	13.5X11	105X80	1000	120	320	287	33



1.000	AY 4307 DDR 200Y	200	50		100	140x110	13.5X11	105X80	200	30	275	223	52
1.000	AY 4307 DDR 200M	200	50		100	140x110	13.5X11	105X80	300	40	275	230	45
1.000	AY 4307 DDR 200K	200	50		100	140x110	13.5X11	105X80	450	60	275	237	38
1.000	AY 4307 DDR 200S	200	50		100	140x110	13.5X11	105X80	600	70	275	245	30
1.400	AY 4307 DDR 250Y	250	50		120	140x110	13.5X11	105X80	300	40	320	265	45
1.400	AY 4307 DDR 250M	250	50		120	140x110	13.5X11	105X80	450	60	320	273	47
1.400	AY 4307 DDR 250K	250	50		120	140x110	13.5X11	105X80	750	100	320	280	40
1.400	AY 4307 DDR 250S	250	50		120	140x110	13.5X11	105X80	1000	120	320	287	33



1.200	AY 4302 DOR 200Y	200	50		100	140x110	13.5X11	105X80	200	30	275	223	52
1.200	AY 4302 DOR 200M	200	50		100	140x110	13.5X11	105X80	300	40	275	230	45
1.200	AY 4302 DOR 200K	200	50		100	140x110	13.5X11	105X80	450	60	275	237	38
1.200	AY 4302 DOR 200S	200	50		100	140x110	13.5X11	105X80	600	70	275	245	30
1.400	AY 4302 DOR 250Y	250	60		120	140x110	13.5X11	105X80	300	40	320	265	45
1.400	AY 4302 DOR 250M	250	60		120	140x110	13.5X11	105X80	450	60	320	273	47
1.400	AY 4302 DOR 250K	250	60		120	140x110	13.5X11	105X80	750	100	320	280	40
1.400	AY 4302 DOR 250S	250	60		120	140x110	13.5X11	105X80	1000	120	320	287	33



1.200	AY 4302 DOR 200 F04Y	200	50	297	100	140x110	13.5X11	105X80	200	30	275	223	52
1.200	AY 4302 DOR 200 F04M	200	50	297	100	140x110	13.5X11	105X80	300	40	275	230	45
1.200	AY 4302 DOR 200 F04K	200	50	297	100	140x110	13.5X11	105X80	450	60	275	237	38
1.200	AY 4302 DOR 200 F04S	200	50	297	100	140x110	13.5X11	105X80	600	70	275	245	30
1.400	AY 4302 DOR 250 F04Y	250	60		120	140x110	13.5X11	105X80	300	40	320	265	45
1.400	AY 4302 DOR 250 F04M	250	60		120	140x110	13.5X11	105X80	450	60	320	273	47
1.400	AY 4302 DOR 250 F04K	250	60		120	140x110	13.5X11	105X80	750	100	320	280	40
1.400	AY 4302 DOR 250 F04S	250	60		120	140x110	13.5X11	105X80	1000	120	320	287	33



1.200	AY 4302 DOR 200 F17Y	200	50	145	100	140x110	13.5X11	105X80	200	30	275	223	52
1.200	AY 4302 DOR 200 F17M	200	50	145	100	140x110	13.5X11	105X80	300	40	275	230	45
1.200	AY 4302 DOR 200 F17K	200	50	145	100	140x110	13.5X11	105X80	450	60	275	237	38
1.200	AY 4302 DOR 200 F17S	200	50	145	100	140x110	13.5X11	105X80	600	70	275	245	30
1.400	AY 4302 DOR 250 F17Y	250	60	145	120	140x110	13.5X11	105X80	300	40	320	265	45
1.400	AY 4302 DOR 250 F17M	250	60	145	120	140x110	13.5X11	105X80	450	60	320	273	47
1.400	AY 4302 DOR 250 F17K	250	60	145	120	140x110	13.5X11	105X80	750	100	320	280	40
1.400	AY 4302 DOR 250 F17S	250	60	145	120	140x110	13.5X11	105X80	1000	120	320	287	33



1.200	AY 4307 DOR 200Y	200	50		100	140x110	13.5X11	105X80	200	30	275	223	52
1.200	AY 4307 DOR 200M	200	50		100	140x110	13.5X11	105X80	300	40	275	230	45
1.200	AY 4307 DOR 200K	200	50		100	140x110	13.5X11	105X80	450	60	275	237	38
1.200	AY 4307 DOR 200S	200	50		100	140x110	13.5X11	105X80	600	70	275	245	30
1.400	AY 4307 DOR 250Y	250	60		120	140x110	13.5X11	105X80	300	40	320	265	45
1.400	AY 4307 DOR 250M	250	60		120	140x110	13.5X11	105X80	450	60	320	273	47
1.400	AY 4307 DOR 250K	250	60		120	140x110	13.5X11	105X80	750	100	320	280	40
1.400	AY 4307 DOR 250S	250	60		120	140x110	13.5X11	105X80	1000	120	320	287	33



1.200	AY 4302 D2OR 200Y	200	50		100	140x110	13.5X11	105X80	200	30	275	223	52
1.200	AY 4302 D2OR 200M	200	50		100	140x110	13.5X11	105X80	300	40	275	230	45
1.200	AY 4302 D2OR 200K	200	50		100	140x110	13.5X11	105X80	450	60	275	237	38
1.200	AY 4302 D2OR 200S	200	50		100	140x110	13.5X11	105X80	600	70	275	245	30
1.400	AY 4302 D2OR 250Y	250	60		120	140x110	13.5X11	105X80	300	40	320	265	45
1.400	AY 4302 D2OR 250M	250	60		120	140x110	13.5X11	105X80	450	60	320	273	47
1.400	AY 4302 D2OR 250K	250	60		120	140x110	13.5X11	105X80	750	100	320	280	40
1.400	AY 4302 D2OR 250S	250	60		120	140x110	13.5X11	105X80	1000	120	320	287	33



1.200	AY 4302 D2OR 200 F04Y	200	50	297	100	140x110	13.5X11	105X80	200	30	275	223	52
1.200	AY 4302 D2OR 200 F04M	200	50	297	100	140x110	13.5X11	105X80	300	40	275	230	45
1.200	AY 4302 D2OR 200 F04K	200	50	297	100	140x110	13.5X11	105X80	450	60	275	237	38
1.200	AY 4302 D2OR 200 F04S	200	50	297	100	140x110	13.5X11	105X80	600	70	275	245	30
1.400	AY 4302 D2OR 250 F04Y	250	60		120	140x110	13.5X11	105X80	300	40	320	265	45
1.400	AY 4302 D2OR 250 F04M	250	60		120	140x110	13.5X11	105X80	450	60	320	273	47
1.400	AY 4302 D2OR 250 F04K	250	60		120	140x110	13.5X11	105X80	750	100	320	280	40
1.400	AY 4302 D2OR 250 F04S	250	60		120	140x110	13.5X11	105X80	1000	120	320	287	33



1.200	AY 4302 D2OR 200 F17Y	200	50	145	100	140x110	13.5X11	105X80	200	30	275	223	52
1.200	AY 4302 D2OR 200 F17M	200	50	145	100	140x110	13.5X11	105X80	300	40	275	230	45
1.200	AY 4302 D2OR 200 F17K	200	50	145	100	140x110	13.5X11	105X80	450	60	275	237	38
1.200	AY 4302 D2OR 200 F17S	200	50	145	100	140x110	13.5X11	105X80	600	70	275	245	30
1.400	AY 4302 D2OR 250 F17Y	250	60	145	120	140x110	13.5X11	105X80	300	40	320	265	45
1.400	AY 4302 D2OR 250 F17M	250	60	145	120	140x110	13.5X11	105X80	450	60	320	273	47
1.400	AY 4302 D2OR 250 F17K	250	60	145	120	140x110	13.5X11	105X80	750	100	320	280	40
1.400	AY 4302 D2OR 250 F17S	250	60	145	120	140x110	13.5X11	105X80	1000	120	320	287	33



1.200	AY 4307 D2OR 200Y	200	50		100	140x110	13.5X11	105X80	200	30	275	223	52
1.200	AY 4307 D2OR 200M	200	50		100	140x110	13.5X11	105X80	300	40	275	230	45
1.200	AY 4307 D2OR 200K	200	50		100	140x110	13.5X11	105X80	450	60	275	237	38
1.200	AY 4307 D2OR 200S	200	50		100	140x110	13.5X11	105X80	600	70	275	245	30
1.400	AY 4307 D2OR 250Y	250	60		120	140x110	13.5X11	105X80	300	40	320	265	45
1.400	AY 4307 D2OR 250M	250	60		120	140x110	13.5X11	105X80	450	60	320	273	47
1.400	AY 4307 D2OR 250K	250	60		120	140x110	13.5X11	105X80	750	100	320	280	40
1.400	AY 4307 D2OR 250S	250	60		120	140x110	13.5X11	105X80	1000	120	320	287	33



320	AY 4302 D2OR 200 D2R	200	50		100	140x110	13.5X11	105X80	200	30	275	223	52
320	AY 4302 D2OR 200M	200	50		100	140x110	13.5X11	105X80	300	40	275	230	45
320	AY 4302 D2OR 200K	200	50		100	140x110	13.5X11	105X80	450	60	275	237	38
320	AY 4302 D2OR 200S	200	50		100	140x110	13.5X11	105X80	600	70	275	245	30
500	AY 4302 D2OR 250Y	250	60		120	140x110	13.5X11	105X80	300	40	320	265	45
500	AY 4302 D2OR 250M	250	60		120	140x110	13.5X11	105X80	450	60	320	273	47
500	AY 4302 D2OR 250K	250	60		120	140x110	13.5X11	105X80	750	100	320	280	40
500	AY 4302 D2OR 250S	250	60		120	140x110	13.5X11	105X80	1000	120	320	287	33



320	AY 4302 DYR 200 F04Y	200	50	297	100	140x110	13.5X11	105X80	200	30	275	223	52
320	AY 4302 DYR 200 F04M	200	50	297	100	140x110	13.5X11	105X80	300	40	275	230	45
320	AY 4302 DYR 200 F04K	200	50	297	100	140x110	13.5X11	105X80	450	60	275	237	38
320	AY 4302 DYR 200 F04S	200	50	297	100	140x110	13.5X11	105X80	600	70	275	245	30
500	AY 4302 DYR 250 F04Y	250	60		120	140x110	13.5X11	105X80	300	40	320	265	45
500	AY 4302 DYR 250 F04M	250	60		120	140x110	13.5X11	105X80	450	60	320	273	47
500	AY 4302 DYR 250 F04K	250	60		120	140x110	13.5X11	105X80	750	100	320	280	40
500	AY 4302 DYR 250 F04S	250	60		120	140x110	13.5X11	105X80	1000	120	320	287	33



320	AY 4302 DYR 200 F17Y	200	50	145	100	140x110	13.5X11	105X80	200	30	275	223	52
320	AY 4302 DYR 200 F17M	200	50	145	100	140x110	13.5X11	105X80	300	40	275	230	45
320	AY 4302 DYR 200 F17K	200	50	145	100	140x110	13.5X11	105X80	450	60	275	237	38
320	AY 4302 DYR 200 F17S	200	50	145	100	140x110	13.5X11	105X80	600	70	275	245	30
500	AY 4302 DYR 250 F17Y	250	60	145	120	140x110	13.5X11	105X80	300	40	320	265	45
500	AY 4302 DYR 250 F17M	250	60	145	120	140x110	13.5X11	105X80	450	60	320	273	47
500	AY 4302 DYR 250 F17K	250	60	145	120	140x110	13.5X11	105X80	750	100	320	280	40
500	AY 4302 DYR 250 F17S	250	60	145	120	140x110	13.5X11	105X80	1000	120	320	287	33



320	AY 4307 DYR 200Y	200	50		100	140x110	13.5X11	105X80	200	30	275	223	52
320	AY 4307 DYR 200M	200	50		100	140x110	13.5X11	105X80	300	40	275	230	45
320	AY 4307 DYR 200K	200	50		100	140x110	13.5X11	105X80	450	60	275	237	38
320	AY 4307 DYR 200S	200	50		100	140x110	13.5X11	105X80	600	70	275	245	30
500	AY 4307 DYR 250Y	250	60		120	140x110	13.5X11	105X80	300	40	320	265	45
500	AY 4307 DYR 250M	250	60		120	140x110	13.5X11	105X80	450	60	320	273	47
500	AY 4307 DYR 250K	250	60		120	140x110	13.5X11	105X80	750	100	320	280	40
500	AY 4307 DYR 250S	250	60		120	140x110	13.5X11	105X80	1000	120	320	287	33



700	AY 4302 KOR 160Y	160	50		100	140x110	13.5X11	105X80	200	30	255	203	52
700	AY 4302 KOR 160M	160	50		100	140x110	13.5X11	105X80	300	40	255	205	45
700	AY 4302 KOR 160K	160	50		100	140x110	13.5X11	105X80	450	60	255	217	38
700	AY 4302 KOR 160S	160	50		100	140x110	13.5X11	105X80	600	70	255	225	30
1000	AY 4302 KOR 200Y	200	50		100	140x110	13.5X11	105X80	200	30	275	223	52
1000	AY 4302 KOR 200M	200	50		100	140x110	13.5X11	105X80	300	40	275	230	45
1000	AY 4302 KOR 200K	200	50		100	140x110	13.5X11	105X80	450	60	275	237	38
1000	AY 4302 KOR 200S	200	50		100	140x110	13.5X11	105X80	600	70	275	245	30



700	AY 4302 KOR 160 F04Y	160	50	288.5	100	140x110	13.5X11	105X80	200	30	255	203	52
700	AY 4302 KOR 160 F04M	160	50	288.5	100	140x110	13.5X11	105X80	300	40	255	205	45
700	AY 4302 KOR 160 F04K	160	50	288.5	100	140x110	13.5X11	105X80	450	60	255	217	38
700	AY 4302 KOR 160 F04S	160	50	288.5	100	140x110	13.5X11	105X80	600	70	255	225	30
1000	AY 4302 KOR 200 F04Y	200	50	297	100	140x110	13.5X11	105X80	200	30	275	223	52
1000	AY 4302 KOR 200 F04M	200	50	297	100	140x110	13.5X11	105X80	300	40	275	230	45
1000	AY 4302 KOR 200 F04K	200	50	297	100	140x110	13.5X11	105X80	450	60	275	237	38
1000	AY 4302 KOR 200 F04S	200	50	297	100	140x110	13.5X11	105X80	600	70	275	245	30



700	AY 4302 KOR 160 F17Y	160	50	145	100	140x110	13.5X11	105X80	200	30	255	203	52
700	AY 4302 KOR 160 F17M	160	50	145	100	140x110	13.5X11	105X80	300	40	255	205	45
700	AY 4302 KOR 160 F17K	160	50	145	100	140x110	13.5X11	105X80	450	60	255	217	38
700	AY 4302 KOR 160 F17S	160	50	145	100	140x110	13.5X11	105X80	600	70	255	225	30
1000	AY 4302 KOR 200 F17Y	200	50	145	100	140x110	13.5X11	105X80	200	30	275	223	52
1000	AY 4302 KOR 200 F17M	200	50	145	100	140x110	13.5X11	105X80	300	40	275	230	45
1000	AY 4302 KOR 200 F17K	200	50	145	100	140x110	13.5X11	105X80	450	60	275	237	38
1000	AY 4302 KOR 200 F17S	200	50	145	100	140x110	13.5X11	105X80	600	70	275	245	30



700	AY 4307 KOR 160Y	160	50		100	140x110	13.5X11	105X80	200	30	255	203	52
700	AY 4307 KOR 160M	160	50		100	140x110	13.5X11	105X80	300	40	255	205	45
700	AY 4307 KOR 160K	160	50		100	140x110	13.5X11	105X80	450	60	255	217	38
700	AY 4307 KOR 160S	160	50		100	140x110	13.5X11	105X80	600	70	255	225	30
1000	AY 4307 KOR 200Y	200	50		100	140x110	13.5X11	105X80	200	30	275	223	52
1000	AY 4307 KOR 200M	200	50		100	140x110	13.5X11	105X80	300	40	275	230	45
1000	AY 4307 KOR 200K	200	50		100	140x110	13.5X11	105X80	450	60	275	237	38
1000	AY 4307 KOR 200S	200	50		100	140x110	13.5X11	105X80	600	70	275	245	30



1000	AY 4302 K2OR 200Y	200	50		100	140x110	13.5X11	105X80	200	30	275	223	52
1000	AY 4302 K2OR 200M	200	50		100	140x110	13.5X11	105X80	300	40	275	230	45
1000	AY 4302 K2OR 200K	200	50		100	140x110	13.5X11	105X80	450	60	275	237	38
1000	AY 4302 K2OR 200S	200	50		100	140x110	13.5X11	105X80	600	70	275	245	30



1000	AY 4302 K2OR 200 F04Y	200	50	297	100	140x110	13.5X11	105X80	200	30	275	223	52
1000	AY 4302 K2OR 200 F04M	200	50	297	100	140x110	13.5X11	105X80	300	40	275	230	45
1000	AY 4302 K2OR 200 F04K	200	50	297	100	140x110	13.5X11	105X80	450	60	275	237	38
1000	AY 4302 K2OR 200 F04S	200	50	297	100	140x110	13.5X11	105X80	600	70	275	245	30



1000	AY 4302 K2OR 200 F17Y	200	50	145	100	140x110	13.5X11	105X80	200	30	275	223	52
1000	AY 4302 K2OR 200 F17M	200	50	145	100	140x110	13.5X11	105X80	300	40	275	230	45
1000	AY 4302 K2OR 200 F17K	200	50	145	100	140x110	13.5X11	105X80	450	60	275	237	38
1000	AY 4302 K2OR 200 F17S	200	50	145	100	140x110	13.5X11	105X80	600	70	275	245	30



1000	AY 4307 K2OR 200Y	200	50		100	140x110	13.5X11	105X80	200	30	275	223	52
1000	AY 4307 K2OR 200M	200	50		100	140x110	13.5X11	105X80	300	40	275	230	45
1000	AY 4307 K2OR 200K	200	50		100	140x110	13.5X11	105X80	450	60	275	237	38
1000	AY 4307 K2OR 200S	200	50		100	140x110	13.5X11	105X80	600	70	275	245	30



700	AY 4302 KUR 160Y	160	50		100	140x110	13.5X11	105X80	200	30	255	203	52
700	AY 4302 KUR 160M	160	50		100	140x110	13.5X11	105X80	300	40	255	205	45
700	AY 4302 KUR 160K	160	50		100	140x110	13.5X11	105X80	450	60	255	217	38
700	AY 4302 KUR 160S	160	50		100	140x110	13.5X11	105X80	600	70	255	225	30
1000	AY 4302 KUR 200Y	200	50		100	140x110	13.5X11	105X80	200	30	275	223	52
1000	AY 4302 KUR 200M	200	50		100	140x110	13.5X11	105X80	300	40	275	230	45
1000	AY 4302 KUR 200K	200	50		100	140x110	13.5X11	105X80	450	60	275	237	38
1000	AY 4302 KUR 200S	200	50		100	140x110	13.5X11	105X80	600	70	275	245	30



700	AY 4302 KUR 160 F04Y	160	50	288.5	100	140x110	13.5X11	105X80	200	30	255	203	52
700	AY 4302 KUR 160 F04M	160	50	288.5	100	140x110	13.5X11	105X80	300	40	255	205	45
700	AY 4302 KUR 160 F04K	160	50	288.5	100	140x110	13.5X11	105X80	450	60	255	217	38
700	AY 4302 KUR 160 F04S	160	50	288.5	100	140x110	13.5X11	105X80	600	70	255	225	30
1000	AY 4302 KUR 200 F04Y	200	50	297	100	140x110	13.5X11	105X80	200	30	275	223	52
1000	AY 4302 KUR 200 F04M	200	50	297	100	140x110	13.5X11	105X80	300	40	275	230	45
1000	AY 4302 KUR 200 F04K	200	50	297	100	140x110	13.5X11	105X80	450	60	275	237	38
1000	AY 4302 KUR 200 F04S	200	50	297	100	140x110	13.5X11	105X80	600	70	275	245	30



700	AY 4302 KUR 160 F17Y	160	50	145	100	140x110	13.5X11	105X80	200	30	255	203	52
700	AY 4302 KUR 160 F17M	160	50	145	100	140x110	13.5X11	105X80	300	40	255	205	45
700	AY 4302 KUR 160 F17K	160	50	145	100	140x110	13.5X11	105X80	450	60	255	217	38
700	AY 4302 KUR 160 F17S	160	50	145	100	140x110	13.5X11	105X80	600	70	255	225	30
1000	AY 4302 KUR 200 F17Y	200	50	145	100	140x110	13.5X11	105X80	200	30	275	223	52
1000	AY 4302 KUR 200 F17M	200	50	145	100	140x110	13.5X11	105X80	300	40	275	230	45
1000	AY 4302 KUR 200 F17K	200	50	145	100	140x110	13.5X11	105X80	450	60	275	237	38
1000	AY 4302 KUR 200 F17S	200	50	145	100	140x110	13.5X11	105X80	600	70	275	245	30



700	AY 4307 KUR 160Y	160	50		100	140x110	13.5X11	105X80	200	30	255	203	52
700	AY 4307 KUR 160M	160	50		100	140x110	13.5X11	105X80	300	40	255	205	45
700	AY 4307 KUR 160K	160	50		100	140x110	13.5X11	105X80	450	60	255	217	38
700	AY 4307 KUR 160S	160	50		100	140x110	13.5X11	105X80	600	70	255	225	30
1000	AY 4307 KUR 200Y	200	50		100	140x110	13.5X11	105X80	200	30	275	223	52
1000	AY 4307 KUR 200M	200	50		100	140x110	13.5X11	105X80	300	40	275	230	45
1000	AY 4307 KUR 200K	200	50		100	140x110	13.5X11	105X80	450	60	275	237	38
1000	AY 4307 KUR 200S	200	50		100	140x110	13.5X11	105X80	600	70	275	245	30



600	AY 4302 PUR 200Y	200	50		100	140x110	13.5X11	105X80	200	30	275	223	52
600	AY 4302 PUR 200M	200	50		100	140x110	13.5X11	105X80	300	40	275	230	45
600	AY 4302 PUR 200K	200	50		100	140x110	13.5X11	105X80	450	60	275	237	38
600	AY 4302 PUR 200S	200	50		100	140x110	13.5X11	105X80	600	70	275	245	30



600	AY 4302 PUR 200 F04Y	200	50	297	100	140x110	13.5X11	105X80	200	30	275	223	52
600	AY 4302 PUR 200 F04M	200	50	297	100	140x110	13.5X11	105X80	300	40	275	230	45
600	AY 4302 PUR 200 F04K	200	50	297	100	140x110	13.5X11	105X80	450	60	275	237	38
600	AY 4302 PUR 200 F04S	200	50	297	100	140x110	13.5X11	105X80	600	70	275	245	30



600	AY 4302 PUR 200 F17Y	200	50	145	100	140x110	13.5X11	105X80	200	30	275	223	52
600	AY 4302 PUR 200 F17M	200	50	145	100	140x110	13.5X11	105X80	300	40	275	230	45
600	AY 4302 PUR 200 F17K	200	50	145	100	140x110	13.5X11	105X80	450	60	275	237	38
600	AY 4302 PUR 200 F17S	200	50	145	100	140x110	13.5X11	105X80	600	70	275	245	30



600	AY 4307 PUR 200Y	200	50		100	140x110	13.5X11	105X80	200	30	275	223	52
600	AY 4307 PUR 200M	200	50		100	140x110	13.5X11	105X80	300	40	275	230	45
600	AY 4307 PUR 200K	200	50		100	140x110	13.5X11	105X80	450	60	275	237	38
600	AY 4307 PUR 200S	200	50		100	140x110	13.5X11	105X80	600	70	275	245	30



300	AY 4302 PYR 200Y	200	50		100	140x110	13.5X11	105X80	200	30	275	223	52
300	AY 4302 PYR 200M	200	50		100	140x110	13.5X11	105X80	300	40	275	230	45
300	AY 4302 PYR 200K	200	50		100	140x110	13.5X11	105X80	450	60	275	237	38
300	AY 4302 PYR 200S	200	50		100	140x110	13.5X11	105X80	600	70	275	245	30



300	AY 4302 PYR 200 F04Y	200	50	297	100	140x110	13.5X11	105X80	200	30	275	223	52
300	AY 4302 PYR 200 F04M	200	50	297	100	140x110	13.5X11	105X80	300	40	275	230	45
300	AY 4302 PYR 200 F04K	200	50	297	100	140x110	13.5X11	105X80	450	60	275	237	38
300	AY 4302 PYR 200 F04S	200	50	297	100	140x110	13.5X11	105X80	600	70	275	245	30



300	AY 4302 PYR 200 F17Y	200	50	145	100	140x110	13.5X11	105X80	200	30	275	223	52
300	AY 4302 PYR 200 F17M	200	50	145	100	140x110	13.5X11	105X80	300	40	275	230	45
300	AY 4302 PYR 200 F17K	200	50	145	100	140x110	13.5X11	105X80	450	60	275	237	38
300	AY 4302 PYR 200 F17S	200	50	145	100	140x110	13.5X11	105X80	600	70	275	245	30



300	AY 4307 PYR 200Y	200	50		100	140x110	13.5X11	105X80	200	30	275	223	52
300	AY 4307 PYR 200M	200	50		100	140x110	13.5X11	105X80	300	40	275	230	45
300	AY 4307 PYR 200K	200	50		100	140x110	13.5X11	105X80	450	60	275	237	38
300	AY 4307 PYR 200S	200	50		100	140x110	13.5X11	105X80	600	70	275	245	30



900	AY 4302 RPR 200Y	200	50		100	140x110	13.5X11	105X80	200	30	275	223	52
900	AY 4302 RPR 200M	200	50		100	140x110	13.5X11	105X80	300	40	275	230	45
900	AY 4302 RPR 200K	200	50		100	140x110	13.5X11	105X80	450	60	275	237	38
900	AY 4302 RPR 200S	200	50		100	140x110	13.5X11	105X80	600	70	275	245	30
1.100	AY 4302 RPR 250Y	250	60		120	140x110	13.5X11	105X80	300	40	320	265	45
1.100	AY 4302 RPR 250M	250	60		120	140x110	13.5X11	105X80	450	60	320	273	47
1.100	AY 4302 RPR 250K	250	60		120	140x110	13.5X11	105X80	750	100	320	280	40
1.100	AY 4302 RPR 250S	250	60		120	140x110	13.5X11	105X80	1000	120	320	287	33



900	AY 4302 RPR 200 F04Y	200	50	297	100	140x110	13.5X11	105X80	200	30	275	223	52
900	AY 4302 RPR 200 F04M	200	50	297	100	140x110	13.5X11	105X80	300	40	275	230	45
900	AY 4302 RPR 200 F04K	200	50	297	100	140x110	13.5X11	105X80	450	60	275	237	38
900	AY 4302 RPR 200 F04S	200	50	297	100	140x110	13.5X11	105X80	600	70	275	245	30
1.100	AY 4302 RPR 250 F04Y	250	60		120	140x110	13.5X11	105X80	300	40	320	265	45
1.100	AY 4302 RPR 250 F04M	250	60		120	140x110	13.5X11	105X80	450	60	320	273	47
1.100	AY 4302 RPR 250 F04K	250	60		120	140x110	13.5X11	105X80	750	100	320	280	40
1.100	AY 4302 RPR 250 F04S	250	60		120	140x110	13.5X11	105X80	1000	120	320	287	33



900	AY 4302 RPR 200 F17Y	200	50	145	100	140x110	13.5X11	105X80	200	30	275	223	52
900	AY 4302 RPR 200 F17M	200	50	145	100	140x110	13.5X11	105X80	300	40	275	230	45
900	AY 4302 RPR 200 F17K	200	50	145	100	140x110	13.5X11	105X80	450	60	275	237	38
900	AY 4302 RPR 200 F17S	200	50	145	100	140x110	13.5X11	105X80	600	70	275	245	30
1.100	AY 4302 RPR 250 F17Y	250	60	145	120	140x110	13.5X11	105X80	300	40	320	265	45
1.100	AY 4302 RPR 250 F17M	250	60	145	120	140x110	13.5X11	105X80	450	60	320	273	47
1.100	AY 4302 RPR 250 F17K	250	60	145	120	140x110	13.5X11	105X80	750	100	320	280	40
1.100	AY 4302 RPR 250 F17S	250	60	145	120	140x110	13.5X11	105X80	1000	120	320	287	33



900	AY 4307 RPR 200Y	200	50		100	140x110	13.5X11	105X80	200	30	275	223	52
900	AY 4307 RPR 200M	200	50		100	140x110	13.5X11	105X80	300	40	275	230	45
900	AY 4307 RPR 200K	200	50		100	140x110	13.5X11	105X80	450	60	275	237	38
900	AY 4307 RPR 200S	200	50		100	140x110	13.5X11	105X80	600	70	275	245	30
1.100	AY 4307 RPR 250Y	250	60		120	140x110	13.5X11	105X80	300	40	320	265	45
1.100	AY 4307 RPR 250M	250	60		120	140x110	13.5X11	105X80	450	60	320	273	47
1.100	AY 4307 RPR 250K	250	60		120	140x110	13.5X11	105X80	750	100	320	280	40
1.100	AY 4307 RPR 250S	250	60		120	140x110	13.5X11	105X80	1000	120	320	287	33

AY5100 Serisi

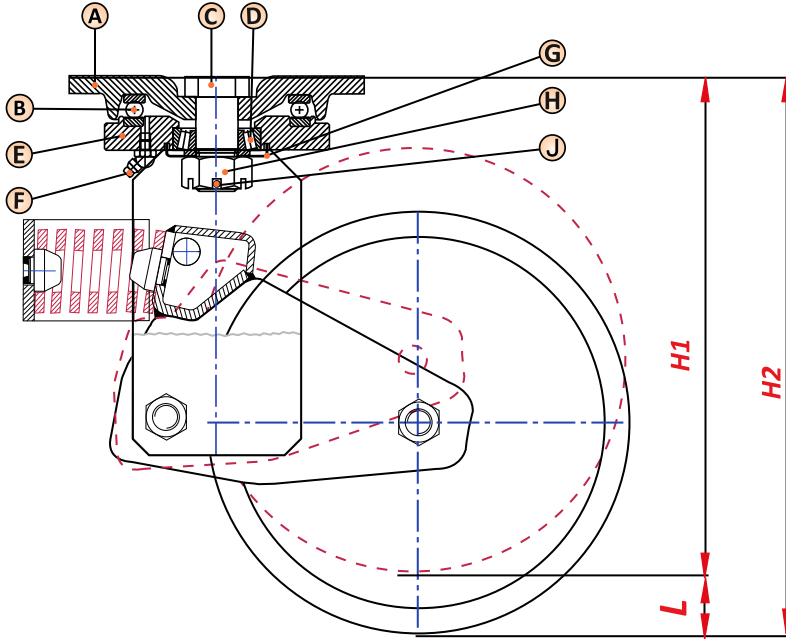

AY5100 Serisi Rulmeler

- A** Sıcak dövmeden imal edilmiş olan 10mm. kalınlığında dikdörtgen tabla.
- B** Emniyetli bir yataklama ve yüksek manevra kabiliyeti sağlayan aksel kuvvetleri bünyesine alan bute rulman.
- C** Kalın tabla bağlantı civatası.
- D** Yüksek manevra kabiliyeti sağlayan konik rulman.
- E** Sıcak dövmeden hassas tornalanarak imal edilmiş üst bilya çanağı.
- F** Rulmanların yağlanması için monte edilen gresörlük.
- G** Su-toz vb. aşındırıcı maddelerin bilya yatağına girmesini engelleyen metal toz muhafaza kapağı.
- H** Ayarlanabilir taçlı somun.
- J** Somun emniyetinin sağlanması amacı için monte edilen tespit gupilyası.

AY5100 serisi

kg	KOD NO	mm	mm	mm	mm	mm	mm	mm	mm	YAYIN SON KUVVETİ kg	ÖN GERME KUVVETİ kg	H2 TOPLAM YÜKSEKLİK mm	H1 YÜKLÜ TOPL. YÜKSEKLİK mm	L YAY YOLU mm
1.000	AY 5102 DDR 200M	200	50		100	175x140	26x15	140x105	300	40	275	235	40	
1.000	AY 5102 DDR 200K	200	50		100	175x140	26x15	140x105	450	60	275	245	30	
1.000	AY 5102 DDR 200S	200	50		100	175x140	26x15	140x105	600	70	275	250	25	
1.400	AY 5102 DDR 250M	250	60		120	175x140	26x15	140x105	450	60	330	290	40	
1.400	AY 5102 DDR 250K	250	60		120	175x140	26x15	140x105	750	100	330	300	30	
1.400	AY 5102 DDR 250S	250	60		120	175x140	26x15	140x105	1000	120	330	305	25	



1.000	AY 5102 DDR 200 F04M	200	50	353	100	175x140	26x15	140x105	300	40	275	235	40
1.000	AY 5102 DDR 200 F04K	200	50	353	100	175x140	26x15	140x105	450	60	275	245	30
1.000	AY 5102 DDR 200 F04S	200	50	353	100	175x140	26x15	140x105	600	70	275	250	25
1.400	AY 5102 DDR 250 F04M	250	60	393	120	175x140	26x15	140x105	450	60	330	290	40
1.400	AY 5102 DDR 250 F04K	250	60	393	120	175x140	26x15	140x105	750	100	330	300	30
1.400	AY 5102 DDR 250 F04S	250	60	393	120	175x140	26x15	140x105	1000	120	330	305	25





1.000	AY 5102 DDR 200 F20M	200	50	173	100	175x140	26x15	140x105	300	40	275	235	40
1.000	AY 5102 DDR 200 F20K	200	50	173	100	175x140	26x15	140x105	450	60	275	245	30
1.000	AY 5102 DDR 200 F20S	200	50	173	100	175x140	26x15	140x105	600	70	275	250	25
1.400	AY 5102 DDR 250 F20M	250	60	173	120	175x140	26x15	140x105	450	60	330	290	40
1.400	AY 5102 DDR 250 F20K	250	60	173	120	175x140	26x15	140x105	750	100	330	300	30
1.400	AY 5102 DDR 250 F20S	250	60	173	120	175x140	26x15	140x105	1000	120	330	305	25



1.000	AY 5107 DDR 200M	200	50		100	175x140	26x15	140x105	300	40	275	235	40
1.000	AY 5107 DDR 200K	200	50		100	175x140	26x15	140x105	450	60	275	245	30
1.000	AY 5107 DDR 200S	200	50		100	175x140	26x15	140x105	600	70	275	250	25
1.400	AY 5107 DDR 250M	250	60		120	175x140	26x15	140x105	450	60	330	290	40
1.400	AY 5107 DDR 250K	250	60		120	175x140	26x15	140x105	750	100	330	300	30
1.400	AY 5107 DDR 250S	250	60		120	175x140	26x15	140x105	1000	120	330	305	25



1.200	AY 5102 DOR 200M	200	50		100	175x140	26x15	140x105	300	40	275	235	40
1.200	AY 5102 DOR 200K	200	50		100	175x140	26x15	140x105	450	60	275	245	30
1.200	AY 5102 DOR 200S	200	50		100	175x140	26x15	140x105	600	70	275	250	25
1.400	AY 5102 DOR 250M	250	60		120	175x140	26x15	140x105	450	60	330	290	40
1.400	AY 5102 DOR 250K	250	60		120	175x140	26x15	140x105	750	100	330	300	30
1.400	AY 5102 DOR 250S	250	60		120	175x140	26x15	140x105	1000	120	330	305	25
1.400	AY 5102 DOR 260M	260	65		120	175x140	26x15	140x105	450	60	335	295	40
1.400	AY 5102 DOR 260K	260	65		120	175x140	26x15	140x105	750	100	335	305	30
1.400	AY 5102 DOR 260S	260	65		120	175x140	26x15	140x105	1000	120	335	310	25
1.600	AY 5102 DOR 300M	300	70		120	175x140	26x15	140x105	450	60	395	355	40
1.600	AY 5102 DOR 300K	300	70		120	175x140	26x15	140x105	750	100	395	365	30
1.600	AY 5102 DOR 300S	300	70		120	175x140	26x15	140x105	1000	120	395	370	25



1.200	AY 5102 DOR 200 F04M	200	50	353	100	175x140	26x15	140x105	300	40	275	235	40
1.200	AY 5102 DOR 200 F04K	200	50	353	100	175x140	26x15	140x105	450	60	275	245	30
1.200	AY 5102 DOR 200 F04S	200	50	353	100	175x140	26x15	140x105	600	70	275	250	25
1.400	AY 5102 DOR 250 F04M	250	60	393	120	175x140	26x15	140x105	450	60	330	290	40
1.400	AY 5102 DOR 250 F04K	250	60	393	120	175x140	26x15	140x105	750	100	330	300	30
1.400	AY 5102 DOR 250 F04S	250	60	393	120	175x140	26x15	140x105	1000	120	330	305	25
1.400	AY 5102 DOR 260 F04M	260	65	393	120	175x140	26x15	140x105	450	60	335	295	40
1.400	AY 5102 DOR 260 F04K	260	65	393	120	175x140	26x15	140x105	750	100	335	305	30
1.400	AY 5102 DOR 260 F04S	260	65	393	120	175x140	26x15	140x105	1000	120	335	310	25
1.600	AY 5102 DOR 300 F04M	300	70	418	120	175x140	26x15	140x105	450	60	395	355	40
1.600	AY 5102 DOR 300 F04K	300	70	418	120	175x140	26x15	140x105	750	100	395	365	30
1.600	AY 5102 DOR 300 F04S	300	70	418	120	175x140	26x15	140x105	1000	120	395	370	25



1.200	AY 5102 DOR 200 F20M	200	50	173	100	175x140	26x15	140x105	300	40	275	235	40
1.200	AY 5102 DOR 200 F20K	200	50	173	100	175x140	26x15	140x105	450	60	275	245	30
1.200	AY 5102 DOR 200 F20S	200	50	173	100	175x140	26x15	140x105	600	70	275	250	25
1.400	AY 5102 DOR 250 F20M	250	60	173	120	175x140	26x15	140x105	450	60	330	290	40
1.400	AY 5102 DOR 250 F20K	250	60	173	120	175x140	26x15	140x105	750	100	330	300	30
1.400	AY 5102 DOR 250 F20S	250	60	173	120	175x140	26x15	140x105	1000	120	330	305	25
1.400	AY 5102 DOR 260 F20M	260	65	173	120	175x140	26x15	140x105	450	60	335	295	40
1.400	AY 5102 DOR 260 F20K	260	65	173	120	175x140	26x15	140x105	750	100	335	305	30
1.400	AY 5102 DOR 260 F20S	260	65	173	120	175x140	26x15	140x105	1000	120	335	310	25
1.600	AY 5102 DOR 300 F20M	300	70	173	120	175x140	26x15	140x105	450	60	395	355	40
1.600	AY 5102 DOR 300 F20K	300	70	173	120	175x140	26x15	140x105	750	100	395	365	30
1.600	AY 5102 DOR 300 F20S	300	70	173	120	175x140	26x15	140x105	1000	120	395	370	25



KOD NO	AY 5107 DOR	200M	200K	200S	250M	250K	250S	260M	260K	260S	300M	300K	300S
1.200	AY 5107 DOR 200M	200	50		100	175x140	26x15	140x105	300	40	275	235	40
1.200	AY 5107 DOR 200K	200	50		100	175x140	26x15	140x105	450	60	275	245	30
1.200	AY 5107 DOR 200S	200	50		100	175x140	26x15	140x105	600	70	275	250	25
1.400	AY 5107 DOR 250M	250	60		120	175x140	26x15	140x105	450	60	330	290	40
1.400	AY 5107 DOR 250K	250	60		120	175x140	26x15	140x105	750	100	330	300	30
1.400	AY 5107 DOR 250S	250	60		120	175x140	26x15	140x105	1000	120	330	305	25
1.400	AY 5107 DOR 260M	260	65		120	175x140	26x15	140x105	450	60	335	295	40
1.400	AY 5107 DOR 260K	260	65		120	175x140	26x15	140x105	750	100	335	305	30
1.400	AY 5107 DOR 260S	260	65		120	175x140	26x15	140x105	100	120	335	310	25
1.600	AY 5107 DOR 300M	300	70		120	175x140	26x15	140x105	450	60	395	355	40
1.600	AY 5107 DOR 300K	300	70		120	175x140	26x15	140x105	750	100	395	365	30
1.600	AY 5107 DOR 300S	300	70		120	175x140	26x15	140x105	1000	120	395	370	25



KOD NO	AY 5102 D2OR	200M	200K	200S	250M	250K	250S	300M	300K	300S			
1.200	AY 5102 D2OR 200M	200	50		100	175x140	26x15	140x105	300	40	275	235	40
1.200	AY 5102 D2OR 200K	200	50		100	175x140	26x15	140x105	450	60	275	245	30
1.200	AY 5102 D2OR 200S	200	50		100	175x140	26x15	140x105	600	70	275	250	25
1.400	AY 5102 D2OR 250M	250	60		120	175x140	26x15	140x105	450	60	330	290	40
1.400	AY 5102 D2OR 250K	250	60		120	175x140	26x15	140x105	750	100	330	300	30
1.400	AY 5102 D2OR 250S	250	60		120	175x140	26x15	140x105	1000	120	330	305	25
1.600	AY 5102 D2OR 300M	300	70		120	175x140	26x15	140x105	450	60	395	355	40
1.600	AY 5102 D2OR 300K	300	70		120	175x140	26x15	140x105	750	100	395	365	30
1.600	AY 5102 D2OR 300S	300	70		120	175x140	26x15	140x105	1000	120	395	370	25



KOD NO	AY 5102 D2OR	200 F04M	200 F04K	200 F04S	250 F04M	250 F04K	250 F04S	300 F04M	300 F04K	300 F04S			
1.200	AY 5102 D2OR 200 F04M	200	50	353	100	175x140	26x15	140x105	300	40	275	235	40
1.200	AY 5102 D2OR 200 F04K	200	50	353	100	175x140	26x15	140x105	450	60	275	245	30
1.200	AY 5102 D2OR 200 F04S	200	50	353	100	175x140	26x15	140x105	600	70	275	250	25
1.400	AY 5102 D2OR 250 F04M	250	60	393	120	175x140	26x15	140x105	450	60	330	290	40
1.400	AY 5102 D2OR 250 F04K	250	60	393	120	175x140	26x15	140x105	750	100	330	300	30
1.400	AY 5102 D2OR 250 F04S	250	60	393	120	175x140	26x15	140x105	1000	120	330	305	25
1.600	AY 5102 D2OR 300 F04M	300	70	418	120	175x140	26x15	140x105	450	60	395	355	40
1.600	AY 5102 D2OR 300 F04K	300	70	418	120	175x140	26x15	140x105	750	100	395	365	30
1.600	AY 5102 D2OR 300 F04S	300	70	418	120	175x140	26x15	140x105	1000	120	395	370	25



KOD NO	AY 5102 D2OR	200 F20M	200 F20K	200 F20S	250 F20M	250 F20K	250 F20S	300 F20M	300 F20K	300 F20S			
1.200	AY 5102 D2OR 200 F20M	200	50	173	100	175x140	26x15	140x105	300	40	275	235	40
1.200	AY 5102 D2OR 200 F20K	200	50	173	100	175x140	26x15	140x105	450	60	275	245	30
1.200	AY 5102 D2OR 200 F20S	200	50	173	100	175x140	26x15	140x105	600	70	275	250	25
1.400	AY 5102 D2OR 250 F20M	250	60	173	120	175x140	26x15	140x105	450	60	330	290	40
1.400	AY 5102 D2OR 250 F20K	250	60	173	120	175x140	26x15	140x105	750	100	330	300	30
1.400	AY 5102 D2OR 250 F20S	250	60	173	120	175x140	26x15	140x105	1000	120	330	305	25
1.600	AY 5102 D2OR 300 F20M	300	70	173	120	175x140	26x15	140x105	450	60	395	355	40
1.600	AY 5102 D2OR 300 F20K	300	70	173	120	175x140	26x15	140x105	750	100	395	365	30
1.600	AY 5102 D2OR 300 F20S	300	70	173	120	175x140	26x15	140x105	1000	120	395	370	25



KOD NO	AY 5107 D2OR	200M	200K	200S	250M	250K	250S	300M	300K	300S			
1.200	AY 5107 D2OR 200M	200	50		100	175x140	26x15	140x105	300	40	275	235	40
1.200	AY 5107 D2OR 200K	200	50		100	175x140	26x15	140x105	450	60	275	245	30
1.200	AY 5107 D2OR 200S	200	50		100	175x140	26x15	140x105	600	70	275	250	25
1.400	AY 5107 D2OR 250M	250	60		120	175x140	26x15	140x105	450	60	330	290	40
1.400	AY 5107 D2OR 250K	250	60		120	175x140	26x15	140x105	750	100	330	300	30
1.400	AY 5107 D2OR 250S	250	60		120	175x140	26x15	140x105	1000	120	330	305	25
1.600	AY 5107 D2OR 300M	300	70		120	175x140	26x15	140x105	450	60	395	355	40
1.600	AY 5107 D2OR 300K	300	70		120	175x140	26x15	140x105	750	100	395	365	30
1.600	AY 5107 D2OR 300S	300	70		120	175x140	26x15	140x105	1000	120	395	370	25



320	AY 5102 Dyr 200M	200	50		100	175x140	26x15	140x105	300	40	275	235	40
320	AY 5102 Dyr 200K	200	50		100	175x140	26x15	140x105	450	60	275	245	30
320	AY 5102 Dyr 200S	200	50		100	175x140	26x15	140x105	600	70	275	250	25
500	AY 5102 Dyr 250M	250	60		120	175x140	26x15	140x105	450	60	330	290	40
500	AY 5102 Dyr 250K	250	60		120	175x140	26x15	140x105	750	100	330	300	30
500	AY 5102 Dyr 250S	250	60		120	175x140	26x15	140x105	1000	120	330	305	25
600	AY 5102 Dyr 300M	300	70		120	175x140	26x15	140x105	450	60	395	355	40
600	AY 5102 Dyr 300K	300	70		120	175x140	26x15	140x105	750	100	395	365	30
600	AY 5102 Dyr 300S	300	70		120	175x140	26x15	140x105	1000	120	395	370	25



320	AY 5102 Dyr 200 F04M	200	50	353	100	175x140	26x15	140x105	300	40	275	235	40
320	AY 5102 Dyr 200 F04K	200	50	353	100	175x140	26x15	140x105	450	60	275	245	30
320	AY 5102 Dyr 200 F04S	200	50	353	100	175x140	26x15	140x105	600	70	275	250	25
500	AY 5102 Dyr 250 F04M	250	60	393	120	175x140	26x15	140x105	450	60	330	290	40
500	AY 5102 Dyr 250 F04K	250	60	393	120	175x140	26x15	140x105	750	100	330	300	30
500	AY 5102 Dyr 250 F04S	250	60	393	120	175x140	26x15	140x105	1000	120	330	305	25
600	AY 5102 Dyr 300 F04M	300	70	418	120	175x140	26x15	140x105	450	60	395	355	40
600	AY 5102 Dyr 300 F04K	300	70	418	120	175x140	26x15	140x105	750	100	395	365	30
600	AY 5102 Dyr 300 F04S	300	70	418	120	175x140	26x15	140x105	1000	120	395	370	25



320	AY 5102 Dyr 200 F20M	200	50	173	100	175x140	26x15	140x105	300	40	275	235	40
320	AY 5102 Dyr 200 F20K	200	50	173	100	175x140	26x15	140x105	450	60	275	245	30
320	AY 5102 Dyr 200 F20S	200	50	173	100	175x140	26x15	140x105	600	70	275	250	25
500	AY 5102 Dyr 250 F20M	250	60	173	120	175x140	26x15	140x105	450	60	330	290	40
500	AY 5102 Dyr 250 F20K	250	60	173	120	175x140	26x15	140x105	750	100	330	300	30
500	AY 5102 Dyr 250 F20S	250	60	173	120	175x140	26x15	140x105	1000	120	330	305	25
600	AY 5102 Dyr 300 F20M	300	70	173	120	175x140	26x15	140x105	450	60	395	355	40
600	AY 5102 Dyr 300 F20K	300	70	173	120	175x140	26x15	140x105	750	100	395	365	30
600	AY 5102 Dyr 300 F20S	300	70	173	120	175x140	26x15	140x105	1000	120	395	370	25



320	AY 5107 Dyr 200M	200	50		100	175x140	26x15	140x105	300	40	275	235	40
320	AY 5107 Dyr 200K	200	50		100	175x140	26x15	140x105	450	60	275	245	30
320	AY 5107 Dyr 200S	200	50		100	175x140	26x15	140x105	600	70	275	250	25
500	AY 5107 Dyr 250M	250	60		120	175x140	26x15	140x105	450	60	330	290	40
500	AY 5107 Dyr 250K	250	60		120	175x140	26x15	140x105	750	100	330	300	30
500	AY 5107 Dyr 250S	250	60		120	175x140	26x15	140x105	1000	120	330	305	25
600	AY 5107 Dyr 300M	300	70		120	175x140	26x15	140x105	450	60	395	355	40
600	AY 5107 Dyr 300K	300	70		120	175x140	26x15	140x105	750	100	395	365	30
600	AY 5107 Dyr 300S	300	70		120	175x140	26x15	140x105	1000	120	395	370	25



1000	AY 5102 Kor 200M	200	50		100	175x140	26x15	140x105	300	40	275	235	40
1000	AY 5102 Kor 200K	200	50		100	175x140	26x15	140x105	450	60	275	245	30
1000	AY 5102 Kor 200S	200	50		100	175x140	26x15	140x105	600	70	275	250	25



1000	AY 5102 Kor 200 F04M	200	50	353	100	175x140	26x15	140x105	300	40	275	235	40
1000	AY 5102 Kor 200 F04K	200	50	353	100	175x140	26x15	140x105	450	60	275	245	30
1000	AY 5102 Kor 200 F04S	200	50	353	100	175x140	26x15	140x105	600	70	275	250	25

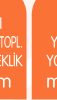

1000	AY 5102 KOR 200 F20M	200	50	173	100	175x140	26x15	140x105	300	40	275	235	40
1000	AY 5102 KOR 200 F20K	200	50	173	100	175x140	26x15	140x105	450	60	275	245	30
1000	AY 5102 KOR 200 F20S	200	50	173	100	175x140	26x15	140x105	600	70	275	250	25



1000	AY 5107 KOR 200M	200	50		100	175x140	26x15	140x105	300	40	275	235	40
1000	AY 5107 KOR 200K	200	50		100	175x140	26x15	140x105	450	60	275	245	30
1000	AY 5107 KOR 200S	200	50		100	175x140	26x15	140x105	600	70	275	250	25



1000	AY 5102 K2OR 200M	200	50		100	175x140	26x15	140x105	300	40	275	235	40
1000	AY 5102 K2OR 200K	200	50		100	175x140	26x15	140x105	450	60	275	245	30
1000	AY 5102 K2OR 200S	200	50		100	175x140	26x15	140x105	600	70	275	250	25



1000	AY 5102 K2OR 200 F04M	200	50	353	100	175x140	26x15	140x105	300	40	275	235	40
1000	AY 5102 K2OR 200 F04K	200	50	353	100	175x140	26x15	140x105	450	60	275	245	30
1000	AY 5102 K2OR 200 F04S	200	50	353	100	175x140	26x15	140x105	600	70	275	250	25



1000	AY 5102 K2OR 200 F20M	200	50	173	100	175x140	26x15	140x105	300	40	275	235	40
1000	AY 5102 K2OR 200 F20K	200	50	173	100	175x140	26x15	140x105	450	60	275	245	30
1000	AY 5102 K2OR 200 F20S	200	50	173	100	175x140	26x15	140x105	600	70	275	250	25



1000	AY 5107 K2OR 200M	200	50		100	175x140	26x15	140x105	300	40	275	235	40
1000	AY 5107 K2OR 200K	200	50		100	175x140	26x15	140x105	450	60	275	245	30
1000	AY 5107 K2OR 200S	200	50		100	175x140	26x15	140x105	600	70	275	250	25



1000	AY 5102 KUR 200M	200	50		100	175x140	26x15	140x105	300	40	275	235	40
1000	AY 5102 KUR 200K	200	50		100	175x140	26x15	140x105	450	60	275	245	30
1000	AY 5102 KUR 200S	200	50		100	175x140	26x15	140x105	600	70	275	250	25



1000	AY 5102 KUR 200 F04M	200	50	353	100	175x140	26x15	140x105	300	40	275	235	40
1000	AY 5102 KUR 200 F04K	200	50	353	100	175x140	26x15	140x105	450	60	275	245	30
1000	AY 5102 KUR 200 F04S	200	50	353	100	175x140	26x15	140x105	600	70	275	250	25



1000	AY 5102 KUR 200 F20M	200	50	173	100	175x140	26x15	140x105	300	40	275	235	40
1000	AY 5102 KUR 200 F20K	200	50	173	100	175x140	26x15	140x105	450	60	275	245	30
1000	AY 5102 KUR 200 F20S	200	50	173	100	175x140	26x15	140x105	600	70	275	250	25



1000	AY 5107 KUR 200M	200	50		100	175x140	26x15	140x105	300	40	275	235	40
1000	AY 5107 KUR 200K	200	50		100	175x140	26x15	140x105	450	60	275	245	30
1000	AY 5107 KUR 200S	200	50		100	175x140	26x15	140x105	600	70	275	250	25



1000	AY 5102 RPR 200M	200	50		100	175x140	26x15	140x105	300	40	275	235	40
1000	AY 5102 RPR 200K	200	50		100	175x140	26x15	140x105	450	60	275	245	30
1000	AY 5102 RPR 200S	200	50		100	175x140	26x15	140x105	600	70	275	250	25



1000	AY 5102 RPR 200 F04M	200	50	353	100	175x140	26x15	140x105	300	40	275	235	40
1000	AY 5102 RPR 200 F04K	200	50	353	100	175x140	26x15	140x105	450	60	275	245	30
1000	AY 5102 RPR 200 F04S	200	50	353	100	175x140	26x15	140x105	600	70	275	250	25



1000	AY 5102 RPR 200 F20M	200	50	173	100	175x140	26x15	140x105	300	40	275	235	40
1000	AY 5102 RPR 200 F20K	200	50	173	100	175x140	26x15	140x105	450	60	275	245	30
1000	AY 5102 RPR 200 F20S	200	50	173	100	175x140	26x15	140x105	600	70	275	250	25



1000	AY 5107 RPR 200M	200	50		100	175x140	26x15	140x105	300	40	275	235	40
1000	AY 5107 RPR 200M	200	50		100	175x140	26x15	140x105	450	60	275	245	30
1000	AY 5107 RPR 200M	200	50		100	175x140	26x15	140x105	600	70	275	250	25

AY6700 Serisi

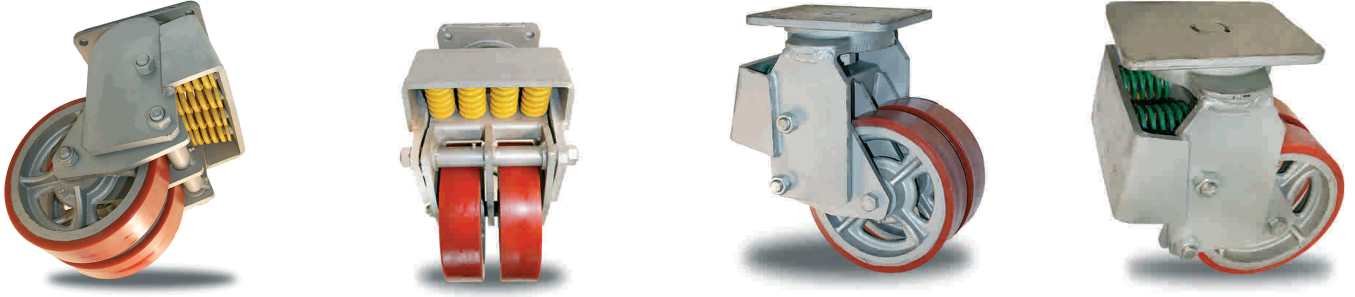

AY6700 Serisi Ruletler

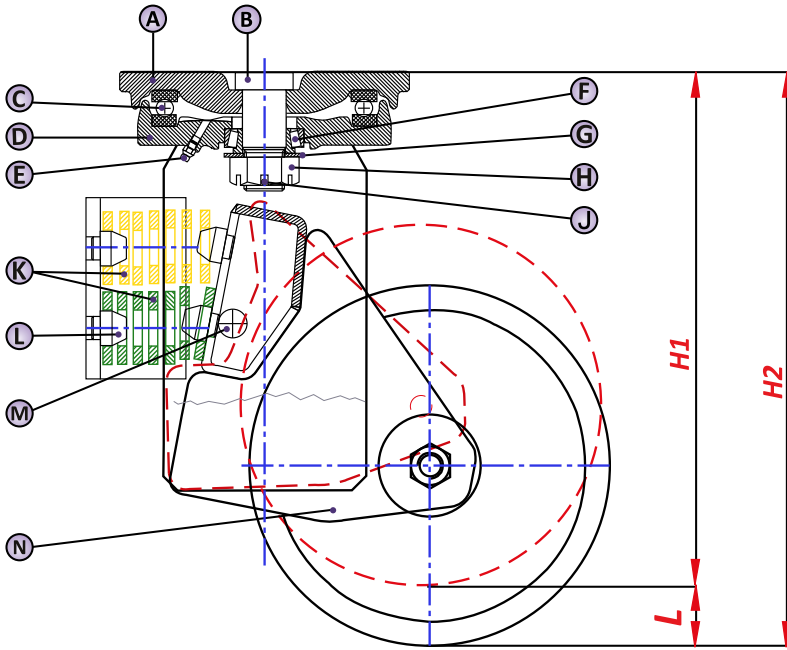

- A** Sıcak dövme çelikten işlenmiş dikdörtgen 4 delikli 14mm. kalınlığında bağlantı tablası.
- B** Güçlendirilmiş ana yataklama mili (tabla civatası).
- C** Eksenel büte rulmanlı üst yataklama.
- D** Sıcak dövme çelikten hassas işlenmiş rulman yataklama flanşı.
- E** Gresörlük ve yağlama kanalı.
- F** Konik rulman (Alt yataklama).
- G** Emniyet rondelası.
- H** Ana yataklama mili taçlı emniyet somunu.
- J** Yaylı pim segman.
- K** Amortisör yayları.
- L** Amortisör maşası ve yataklama mekanizması.
- M** Rulet ve amortisör emniyet mili.
- N** Amortisörlü rulet maşası mafsalı (Milli).

AY6700
serisi



kg

KOD NO



mm



mm



mm



mm



mm



mm



mm



mm



mm



mm



mm



mm



mm



2800	AY 6702 DOR 250K	250	60	115	250X200	17	210X160	1900	250	401	361	34
2800	AY 6702 DOR 260K	260	65	115	250X200	17	210x160	1900	250	406	371	34



2800	AY 6707 DOR 250K	250	60	115	250X200	17	210X160	1900	250	401	361	34
2800	AY 6707 DOR 260K	260	65	115	250X200	17	210x160	1900	250	406	371	34



2800	AY 6702 D2OR 250K	250	60	115	250X200	17	210X160	1900	250	401	361	34
------	-------------------	-----	----	-----	---------	----	---------	------	-----	-----	-----	----



2800	AY 6707 D2OR 250K	250	60	115	250X200	17	210X160	1900	250	401	361	34
------	-------------------	-----	----	-----	---------	----	---------	------	-----	-----	-----	----



2800	AY 6702 RPR 250K	250	60	115	250X200	17	210X160	1900	250	401	361	34
------	------------------	-----	----	-----	---------	----	---------	------	-----	-----	-----	----



2800	AY 6707 RPR 250K	250	60	115	250X200	17	210X160	1900	250	401	361	34
------	------------------	-----	----	-----	---------	----	---------	------	-----	-----	-----	----

www.kama.com.tr



KAMA PRES SANAYİ ve TİCARET A.Ş.

Evren Mahallesi Gülbahar Caddesi No: 92
34212 Bağcılar - İSTANBUL - TURKEY

Tel: +90.212.655 21 00 PBX • Fax: +90.212.550 35 29
www.kama.com.tr • e-mail: satis@kama.com.tr

