

4100 *Serisi*



4300 *Serisi*





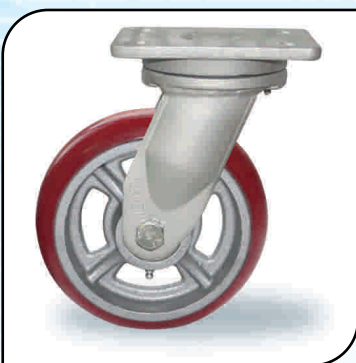



4400 *Serisi*



5100 *Serisi*

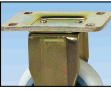

6700 *Serisi*

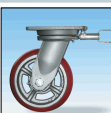



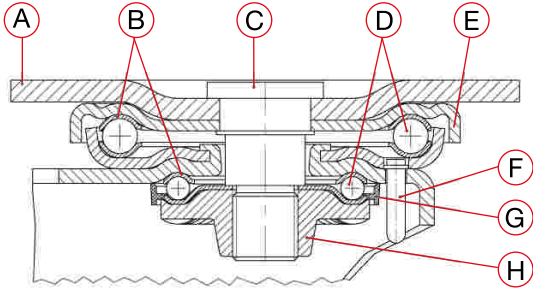
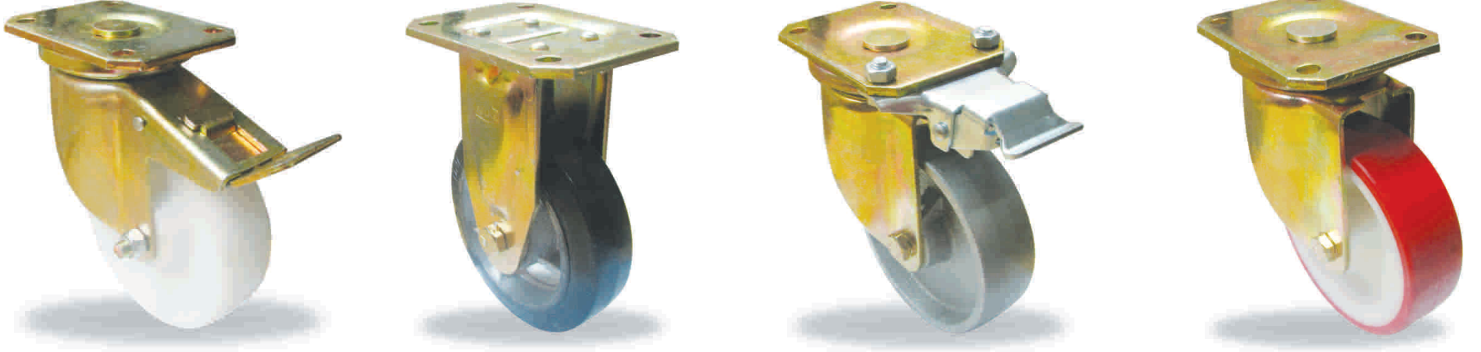













41 ↓ SERİ KODU	02 ↓ BAĞLANTI TİPİ	D ↓ GÖVDE CİNSİ	2 ↓ SIRT TİPİ	O ↓ SIRT MALZEMESİ	R ↓ YATAK TİPİ	200 ↓ TEKER ÇAPİ (Ømm)	F18 ↓ FREN SİSTEMİ	T ↓ İLAVE BİLGİ HANESİ
41	01 CİVATA 	A POLİMİD 66	1	A POLİAMİD 66	A	55	F09 	T 
43	02 TABLA 	B ISIYA DAYANIKLI BAKALİT	2 DERİN RADYÜSLÜ (OVAL) SIRT TİPİ	B ISIYA DAYANIKLI BAKALİT	B BURÇ YATAKLAMAŞI GÖVDENİN KENDİ	80	F18 	SAC JANT KAPAKLI
44	07 SABİT MAŞA 	C TAKVİYELİ PP	3 ÜÇ KANALLI SIRT FÖRMLÜ (MARKET TİPİ)	C PLASTİK (P.V.C.)	C ISIYA DAYANIKLI BURÇ	100	F17 	
51		D PİK (DÖKÜM)	4 U PROFİLLİ GÖVDEDEN BOMBELİ (F16-MARKET TİPİ)	D PİK (DÖKÜM)	D DEMİR BURÇ	125	F20 	
67		E	5	E GRİ LASTİK	E	150		
		F POLİAMİD 6 KÜTÜK	6	F POLİAMİD 6 KÜTÜK	F	160		
		G	7	G	G	170		
		H	8	H HAVALI LASTİK	H	200		
		I	9	I	I	220		
		K KAMALON		K KAMALON	K	250		
		L		L SİYAH LASTİK	L	260		
		M POLİPROPİLEN		M POLİPROPİLEN	M DİZME MİSKET BİLYALI YATAKLAMA	270		
		N TAKVİYELİ PA6		N TAKVİYELİ PA6	N	300		
		O		O DÖKME POLİURETAN	O			
		P POLİAMİD 6		P POLİAMİD 6	P POLİAMİD BURÇLU YATAKLAMA			
		R AĞIR TİP		R MAVİ LASTİK	R BİLYA RULMANLI YATAKLAMA			
		S SAC		S YARI HAVALI (DUBLEKS) LASTİK	S MASURALI YATAKLAMA			
		T		T TERMOELASTİK LASTİK	T			
		U		U ENJEKSİYON BASKI POLİURETAN	U			
		V		V VULKANİZE LASTİK	V			
		Y		Y AĞIR TİP VULKANİZE LASTİK	Y			
		Z ALAŞIMLI ALÜMİNYUM		Z	Z			













4100 Serisi

























AĞIR SANAYİ TİPİ DÖNER RULETLER





























- A:** Hidrolik preste forması vurulmuş 6mm. kalınlığında olan üst tabla.
- B:** CK60 malzemeden sertleştirilmiş bilya yatakları.
- C:** Güçlendirilmiş tabla civatası.
- D:** 52 HRC sertliğinde çift sıra dizme bilya ile yataklandırılmıştır.
- E:** Su ve toz ile teması engelleyen üst bilya kapağı.
- F:** 360° döner maşalarda yağlamanın yapılabilmesi için gresörlük konulmuştur.
- G:** Küresel bilyalar için toz muhafazası.
- H:** Yekpare alt bilya çanağı ve Taç somunlu fren dişlisi.

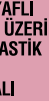

















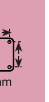









 mm	 mm	 mm	 mm	 mm	 mm	 mm	 mm	 mm	 mm	 mm	 mm	 mm	 mm	 mm	 mm	 mm	 mm	 mm	mm	mm	mm	mm	mm	mm	mm	mm	mm	mm	mm	mm	mm	mm	mm	mm	mm	mm	mm	mm	mm	mm	mm	mm	mm	mm	mm	mm	mm	mm	mm	mm	mm	mm	mm	mm	mm	mm	mm	mm	mm	mm	mm	mm	mm	mm	mm	mm	mm	mm	mm	mm	mm	mm	mm	mm	mm	mm	mm	mm	mm	mm	mm	mm	mm	mm	mm	mm	mm	mm	mm	mm	mm	mm	mm	mm	mm	mm	mm	mm	mm	mm	mm	mm	mm	mm	mm	mm	mm	mm	mm	mm	mm	mm	mm	mm	mm	mm	mm	mm	mm	mm	mm	mm	mm	mm	mm	mm	mm	mm	mm	mm	mm	mm	mm	mm	mm	mm	mm	mm	mm	mm	mm	mm	mm	mm	mm	mm	mm	mm	mm	mm	mm	mm	mm	mm	mm	mm	mm	mm	mm	mm	mm	mm	mm	mm	mm	mm	mm	mm	mm	mm	mm	mm	mm	mm	mm	mm	mm	mm	mm	mm	mm	mm	mm	mm	mm	mm	mm	mm	mm	mm	mm	mm	mm	mm	mm	mm	mm	mm	mm	mm	mm	mm	mm	mm	mm	mm	mm	mm	mm	mm	mm	mm	mm	mm	mm	mm	mm	mm	mm	mm	mm	mm	mm	mm	mm	mm	mm	mm	mm	mm	mm	mm	mm	mm	mm	mm	mm	mm	mm	mm	mm	mm	mm	mm	mm	mm	mm	mm	mm	mm	mm	mm	mm	mm	mm	mm	mm	mm	mm	mm	mm	mm	mm	mm	mm	mm	mm	mm	mm	mm	mm	mm	mm	mm	mm	mm	mm	mm	mm	mm	mm	mm	mm	mm	mm	mm	mm	mm	mm	mm	mm	mm	mm	mm	mm	mm	mm	mm	mm	mm	mm	mm	mm	mm	mm	mm	mm	mm	mm	mm	mm	mm	
---	--	--	--	--	--	--	--	--	--	--	--	---	--	--	--	--	--	--	--	--	--	--	--	--	--	--	--	--	--	--	--	--	--	--	--	--	--	--	--	--	--	--	--	--	--	--	--	--	--	--	--	--	--	--	--	--	--	--	--	--	--	--	--	--	--	--	--	--	--	--	--	--	--	--	--	--	--	--	--	--	--	--	--	--	--	--	--	--	--	--	--	--	--	--	--	--	--	--	--	--	--	--	---	---	---	---	---	---	---	---	---	---	---	---	---	---	---	---	---	---	---	---	---	---	---	---	---	---	---	---	---	---	---	---	---	---	---	---	---	---	---	---	---	---	---	---	---	---	---	---	---	---	---	---	---	---	---	---	---	---	---	---	---	---	---	---	---	---	---	---	---	---	---	---	---	---	---	---	---	---	---	---	---	---	---	---	---	---	---	---	---	---	---	---	---	---	---	---	---	---	---	---	---	---	---	---	---	---	---	---	---	---	---	---	---	---	---	---	---	---	---	---	---	---	---	---	---	---	---	---	---	---	---	---	---	---	---	---	---	---	---	---	---	---	---	---	---	---	---	---	---	---	---	---	---	---	---	---	---	---	---	---	---	---	---	---	---	---	---	---	---	---	---	---	---	---	---	---	---	---	---	---	---	---	---	---	---	---	---	---	---	---	---	---	---	---	---	---	---	---	---	---	---	---	---	---	---	---	---	---	---	---	--

















										POLIAMİD TEKER BURÇLU			POLIAMİD TEKER MASURALI			POLIAMİD TEKER RULMANLI
mm	mm	mm	mm	mm	mm	mm	mm	kg	RPB		kg	RPS		kg	RPR	
125	40	176	48.25	-	140x110	105x80	13.5x11	500	4102-RPB-125		500	4102-RPS-125		500	4102-RPR-125	
125	40	176	48.25	145	140x110	105x80	13.5x11	500	4102-RPB-125F17		500	4102-RPS-125F17		500	4102-RPR-125F17	
125	40	176	51	166	140x110	105x80	13.5x11	500	4102-RPB-125F18		500	4102-RPS-125F18		500	4102-RPR-125F18	
125	40	176	-	-	140x110	105x80	13.5x11	500	4107-RPB-125		500	4107-RPS-125		500	4107-RPR-125	
150	45	206	51.75	-	140x110	105x80	13.5x11	600	4102-RPB-150		600	4102-RPS-150		600	4102-RPR-150	
150	45	206	51.75	145	140x110	105x80	13.5x11	600	4102-RPB-150F17		600	4102-RPS-150F17		600	4102-RPR-150F17	
150	45	206	56.5	165	140x110	105x80	13.5x11	600	4102-RPB-150F18		600	4102-RPS-150F18		600	4102-RPR-150F18	
150	45	206	-	-	140x110	105x80	13.5x11	600	4107-RPB-150		600	4107-RPS-150		600	4107-RPR-150	
170	45	216	51.75	-	140x110	105x80	13.5x11	700	4102-RPB-170		700	4102-RPS-170		700	4102-RPR-170	
170	45	216	51.75	145	140x110	105x80	13.5x11	700	4102-RPB-170F17		700	4102-RPS-170F17		700	4102-RPR-170F17	
170	45	216	51.75	144	140x110	105x80	13.5x11	700	4102-RPB-170F09		700	4102-RPS-170F09		700	4102-RPR-170F09	
170	45	216	-	-	140x110	105x80	13.5x11	700	4107-RPB-170		700	4107-RPS-170		700	4107-RPR-170	
200	50	247	58	-	140x110	105x80	13.5x11	900	4102-RPB-200		900	4102-RPS-200		900	4102-RPR-200	
200	50	247	58	145	140x110	105x80	13.5x11	900	4102-RPB-200F17		900	4102-RPS-200F17		900	4102-RPR-200F17	
200	50	247	60	162	140x110	105x80	13.5x11	900	4102-RPB-200F18		900	4102-RPS-200F18		900	4102-RPR-200F18	
200	50	249	-	-	140x110	105x80	13.5x11	900	4107-RPB-200		900	4107-RPS-200		900	4107-RPR-200	



































































									MOBLEN TEKER BURÇLU
mm	mm	mm	mm	mm	mm	mm	kg	RMB	
55	25	87	26	-	M12	20	120	4101-RMB-055	
55	25	87	26	91	M12	20	120	4101-RMB-055F18	













										MOBLEN TEKER BURÇLU			MOBLEN TEKER MASURALI			BAKALİT +250°C BURÇLU
mm	mm	mm	mm	mm	mm	mm	mm	kg	RMB		kg	RMS		kg	BBC	
55	25	87	26	-	79x70	60x50	8.3x9.6	120	4102-RMB-055		-	-		-	-	-
55	25	87	26	91	79x70	60x50	8.3x9.6	120	4102-RMB-055F18		-	-		-	-	-
55	25	87	-	-	79x70	60x50	8.3x9.6	120	4107-RMB-055		-	-		-	-	-
80	30	116	40	-	105x80	80x60	12x9	200	4102-RMB-080		-	-		120	4102-BBC-080	
80	30	116	40	121	105x80	80x60	12x9	200	4102-RMB-080F18		-	-		120	4102-BBC-080F17	
80	30	116	-	-	105x80	80x60	12x9	200	4107-RMB-080		-	-		120	4107-BBC-080	
100	35	144	46.5	-	140x110	105x80	13.5x11	300	4102-RMB-100		300	4102-RMS-100		150	4102-BBC-100	
100	35	144	46.5	145	140x110	105x80	13.5x11	300	4102-RMB-100F17		300	4102-RMS-100F17		150	4102-BBC-100F17	
100	35	144	50.5	163	140x110	105x80	13.5x11	300	4102-RMB-100F18		300	4102-RMS-100F18		-	-	-
100	35	144	-	-	140x110	105x80	13.5x11	300	4107-RMB-100		300	4107-RMS-100		150	4107-BBC-100	
125	40	176	48.25	-	140x110	105x80	13.5x11	400	4102-RMB-125		400	4102-RMS-125		300	4102-BBC-125	
125	40	176	48.25	145	140x110	105x80	13.5x11	400	4102-RMB-125F17		400	4102-RMS-125F17		300	4102-BBC-125F17	
125	40	176	51	166	140x110	105x80	13.5x11	400	4102-RMB-125F18		400	4102-RMS-125F18		-	-	-
125	40	176	-	-	140x110	105x80	13.5x11	400	4107-RMB-125		400	4107-RMS-125		300	4107-BBC-125	
150	45	206	51.75	-	140x110	105x80	13.5x11	500	4102-RMB-150		500	4102-RMS-150		450	4102-BBC-150	
150	45	206	51.75	145	140x110	105x80	13.5x11	500	4102-RMB-150F17		500	4102-RMS-150F17		450	4102-BBC-150F17	
150	45	206	56.5	165	140x110	105x80	13.5x11	500	4102-RMB-150F18		500	4102-RMS-150F18		-	-	-
150	45	206	-	-	140x110	105x80	13.5x11	500	4107-RMB-150		500	4107-RMS-150		450	4107-BBC-150	
170	45	216	51.75	-	140x110	105x80	13.5x11	600	4102-RMB-170		600	4102-RMS-170		-	-	-
170	45	216	51.75	145	140x110	105x80	13.5x11	600	4102-RMB-170F17		600	4102-RMS-170F17		-	-	-
170	45	216	51.75	144	140x110	105x80	13.5x11	600	4102-RMB-170F09		600	4102-RMS-170F09		-	-	-
170	45	216	-	-	140x110	105x80	13.5x11	600	4107-RMB-170		600	4107-RMS-170		-	-	-
200	50	247	58	-	140x110	105x80	13.5x11	800	4102-RMB-200		800	4102-RMS-200		600	4102-BBC-200	
200	50	247	58	145	140x110	105x80	13.5x11	800	4102-RMB-200F17		800	4102-RMS-200F17		600	4102-BBC-200F17	
200	50	247	60	162	140x110	105x80	13.5x11	800	4102-RMB-200F18		800	4102-RMS-200F18		-	-	-
200	50	249	-	-	140x110	105x80	13.5x11	800	4107-RMB-200		800	4107-RMS-200		600	4107-BBC-200	















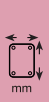

																								
mm	mm	mm	mm	mm	mm	mm	mm	mm	mm	mm	mm	mm	mm	mm	mm	mm	mm	mm	mm	mm	mm	mm	mm	mm
kg	kg	kg	kg	kg	kg	kg	kg	kg	kg	kg	kg	kg	kg	kg	kg	kg	kg	kg	kg	kg	kg	kg	kg	kg
												CAM ELYAFLI MOBLEN ÜZERİ TERMOLASTİK KAPLI BURÇLU		kg		CAM ELYAFLI MOBLEN ÜZERİ TERMOLASTİK KAPLI MASURALI		kg		CAM ELYAFLI MOBLEN ÜZERİ TERMOLASTİK KAPLI RULMANLI				
80	30	116	40	-	105x80	80x60	12x9	90	4102-CTB-080	90	4102-CTS-080	-	-											
80	30	116	40	121	105x80	80x60	12x9	90	4102-CTB-080F18	90	4102-CTS-080F18	-	-											
80	30	116			105x80	80x60	12x9	90	4107-CTB-080	90	4107-CTS-080	-	-											
100	35	144	46.5	-	140x110	105x80	13.5x11	120	4102-CTB-100	120	4102-CTS-100	120	4102-CTR-100											
100	35	144	46.5	145	140x110	105x80	13.5x11	120	4102-CTB-100F17	120	4102-CTS-100F17	120	4102-CTR-100F17											
100	35	144	50.5	163	140x110	105x80	13.5x11	120	4102-CTB-100F18	120	4102-CTS-100F18	120	4102-CTR-100F18											
100	35	144	-		140x110	105x80	13.5x11	120	4107-CTB-100	120	4107-CTS-100	120	4107-CTR-100											
125	40	176	48.25	-	140x110	105x80	13.5x11	150	4102-CTB-125	150	4102-CTS-125	150	4102-CTR-125											
125	40	176	48.25	145	140x110	105x80	13.5x11	150	4102-CTB-125F17	150	4102-CTS-125F17	150	4102-CTR-125F17											
125	40	176	51	166	140x110	105x80	13.5x11	150	4102-CTB-125F18	150	4102-CTS-125F18	150	4102-CTR-125F18											
125	40	176	-		140x110	105x80	13.5x11	150	4107-CTB-125	150	4107-CTS-125	150	4107-CTR-125											
150	45	206	51.75	-	140x110	105x80	13.5x11	180	4102-CTB-150	180	4102-CTS-150	180	4102-CTR-150											
150	45	206	51.75	145	140x110	105x80	13.5x11	180	4102-CTB-150F17	180	4102-CTS-150F17	180	4102-CTR-150F17											
150	45	206	56.5	165	140x110	105x80	13.5x11	180	4102-CTB-150F18	180	4102-CTS-150F18	180	4102-CTR-150F18											
150	45	206	-		140x110	105x80	13.5x11	180	4107-CTB-150	180	4107-CTS-150	180	4107-CTR-150											
200	50	247	58	-	140x110	105x80	13.5x11	250	4102-CTB-200	250	4102-CTS-200	250	4102-CTR-200											
200	50	247	58	145	140x110	105x80	13.5x11	250	4102-CTB-200F17	250	4102-CTS-200F17	250	4102-CTR-200F17											
200	50	247	60	162	140x110	105x80	13.5x11	250	4102-CTB-200F18	250	4102-CTS-200F18	250	4102-CTR-200F18											
200	50	249	-		140x110	105x80	13.5x11	250	4107-CTB-200	250	4107-CTS-200	250	4107-CTR-200											















																								
mm	mm	mm	mm	mm	mm	mm	mm	mm	mm	mm	mm	mm	mm	mm	mm	mm	mm	mm	mm	mm	mm	mm	mm	mm
kg	kg	kg	kg	kg	kg	kg	kg	kg	kg	kg	kg	kg	kg	kg	kg	kg	kg	kg	kg	kg	kg	kg	kg	kg
												POLİAMİD KASNAK ÜZERİ VULKANİZE LASTİK KAPLI BURÇLU		kg		POLİAMİD KASNAK ÜZERİ VULKANİZE LASTİK KAPLI MASURALI		kg		POLİAMİD KASNAK ÜZERİ VULKANİZE LASTİK KAPLI RULMANLI				
80	30	116	40	-	105x80	80x60	12x9	100	4102-PYB-080	100	4102-PYS-080	-	-											
80	30	116	40	121	105x80	80x60	12x9	100	4102-PYB-080F18	100	4102-PYS-080F18	-	-											
80	30	116			105x80	80x60	12x9	100	4107-PYB-080	100	4107-PYS-080	-	-											
100	35	144	46.5	-	140x110	105x80	13.5x11	120	4102-PYB-100	120	4102-PYS-100	120	4102-PYR-100											
100	35	144	46.5	145	140x110	105x80	13.5x11	120	4102-PYB-100F17	120	4102-PYS-100F17	120	4102-PYR-100F17											
100	35	144	50.5	163	140x110	105x80	13.5x11	120	4102-PYB-100F18	120	4102-PYS-100F18	120	4102-PYR-100F18											
100	35	144	-		140x110	105x80	13.5x11	120	4107-PYB-100	120	4107-PYS-100	120	4107-PYR-100											
125	40	176	48.25	-	140x110	105x80	13.5x11	150	4102-PYB-125	150	4102-PYS-125	150	4102-PYR-125											
125	40	176	48.25	145	140x110	105x80	13.5x11	150	4102-PYB-125F17	150	4102-PYS-125F17	150	4102-PYR-125F17											
125	40	176	51	166	140x110	105x80	13.5x11	150	4102-PYB-125F18	150	4102-PYS-125F18	150	4102-PYR-125F18											
125	40	176	-		140x110	105x80	13.5x11	150	4107-PYB-125	150	4107-PYS-125	150	4107-PYR-125											
150	45	206	51.75	-	140x110	105x80	13.5x11	180	4102-PYB-150	180	4102-PYS-150	180	4102-PYR-150											
150	45	206	51.75	145	140x110	105x80	13.5x11	180	4102-PYB-150F17	180	4102-PYS-150F17	180	4102-PYR-150F17											
150	45	206	56.5	165	140x110	105x80	13.5x11	180	4102-PYB-150F18	180	4102-PYS-150F18	180	4102-PYR-150F18											
150	45	206	-		140x110	105x80	13.5x11	180	4107-PYB-150	180	4107-PYS-150	180	4107-PYR-150											
200	50	247	58	-	140x110	105x80	13.5x11	300	4102-PYB-200	300	4102-PYS-200	300	4102-PYR-200											
200	50	247	58	145	140x110	105x80	13.5x11	300	4102-PYB-200F17	300	4102-PYS-200F17	300	4102-PYR-200F17											
200	50	247	60	162	140x110	105x80	13.5x11	300	4102-PYB-200F18	300	4102-PYS-200F18	300	4102-PYR-200F18											
200	50	249	-		140x110	105x80	13.5x11	300	4107-PYB-200	300	4107-PYS-200	300	4107-PYR-200											















										POLİAMİD ÜZERİ POLİÜRETAN KAPLI BURÇLU			POLİAMİD ÜZERİ POLİÜRETAN KAPLI RULMANLI
55	25	87	26		M12	20	70			4101-PUB-055	70		4101-PUR-055
55	25	87	26	91	M12	20	70			4101-PUB-055F18	70		4101-PUR-055F18















											POLİAMİD ÜZERİ POLİÜRETAN KAPLI BURÇLU			POLİAMİD ÜZERİ POLİÜRETAN KAPLI MASURALI			POLİAMİD ÜZERİ POLİÜRETAN KAPLI RULMANLI
55	25	87	26	-	79x70	60x50	8.3x9.6	70			4102-PUB-055	-		-	70		4102-PUR-055
55	25	87	26	91	79x70	60x50	8.3x9.6	70			4102-PUB-055F18	-		-	70		4102-PUR-055F18
55	25	87		-	79x70	60x50	8.3x9.6	70			4107-PUB-055	-		-	70		4107-PUR-055
80	30	116	40	-	105x80	80x60	12x9	140			4102-PUB-080	-		-	-		-
80	30	116	40	121	105x80	80x60	12x9	140			4102-PUB-080F18	-		-	-		-
80	30	116			105x80	80x60	12x9	140			4107-PUB-080	-		-	-		-
100	35	144	46.5	-	140x110	105x80	13.5x11	160			4102-PUB-100	160		4102-PUS-100	160		4102-PUR-100
100	35	144	46.5	145	140x110	105x80	13.5x11	160			4102-PUB-100F17	160		4102-PUS-100F17	160		4102-PUR-100F17
100	35	144	50.5	163	140x110	105x80	13.5x11	160			4102-PUB-100F18	160		4102-PUS-100F18	160		4102-PUR-100F18
100	35	144	-		140x110	105x80	13.5x11	160			4107-PUB-100	160		4107-PUS-100	160		4107-PUR-100
125	40	176	48.25	-	140x110	105x80	13.5x11	250			4102-PUB-125	250		4102-PUS-125	250		4102-PUR-125
125	40	176	48.25	145	140x110	105x80	13.5x11	250			4102-PUB-125F17	250		4102-PUS-125F17	250		4102-PUR-125F17
125	40	176	51	166	140x110	105x80	13.5x11	250			4102-PUB-125F18	250		4102-PUS-125F18	250		4102-PUR-125F18
125	40	176	-		140x110	105x80	13.5x11	250			4107-PUB-125	250		4107-PUS-125	250		4107-PUR-125
150	45	206	51.75	-	140x110	105x80	13.5x11	400			4102-PUB-150	400		4102-PUS-150	400		4102-PUR-150
150	45	206	51.75	145	140x110	105x80	13.5x11	400			4102-PUB-150F17	400		4102-PUS-150F17	400		4102-PUR-150F17
150	45	206	56.5	165	140x110	105x80	13.5x11	400			4102-PUB-150F18	400		4102-PUS-150F18	400		4102-PUR-150F18
150	45	206	-		140x110	105x80	13.5x11	400			4107-PUB-150	400		4107-PUS-150	400		4107-PUR-150
200	50	247	58	-	140x110	105x80	13.5x11	600			4102-PUB-200	600		4102-PUS-200	600		4102-PUR-200
200	50	247	58	145	140x110	105x80	13.5x11	600			4102-PUB-200F17	600		4102-PUS-200F17	600		4102-PUR-200F17
200	50	247	60	162	140x110	105x80	13.5x11	600			4102-PUB-200F18	600		4102-PUS-200F18	600		4102-PUR-200F18
200	50	249	-		140x110	105x80	13.5x11	600			4107-PUB-200	600		4107-PUS-200	600		4107-PUR-200













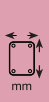

										DÖKÜM TEKER BURÇLU
55	25	87	26		M12	20	150			4101-DDB-055
55	25	87	26	91	M12	20	150			4101-DDB-055F18

											DÖKÜM TEKER BURÇLU
55	25	87	26	-	79x70	60x50	8.3x9.6	150			4102-DDB-055
55	25	87	26	91	79x70	60x50	8.3x9.6	150			4102-DDB-055F18
55	25	87			79x70	60x50	8.3x9.6	150			4107-DDB-055
80	30	116	40	-	105x80	80x60	12x9	200			4102-DDB-080
80	30	116	40	121	105x80	80x60	12x9	200			4102-DDB-080F18
80	30	116			105x80	80x60	12x9	200			4107-DDB-080

											DÖKÜM TEKER BURÇLU			DÖKÜM TEKER MASURALI			DÖKÜM TEKER RULMANLI
mm	mm	mm	mm	mm	mm	mm	mm	mm	kg	DDB		kg	DDS		kg	DDR	
100	35	144	46.5	-	140x110	105x80	13.5x11	450	450	4102-DDB-100		450	4102-DDS-100		450	4102-DDR-100	
100	35	144	46.5	145	140x110	105x80	13.5x11	450	450	4102-DDB-100F17		450	4102-DDS-100F17		450	4102-DDR-100F17	
100	35	144	50.5	163	140x110	105x80	13.5x11	450	450	4102-DDB-100F18		450	4102-DDS-100F18		450	4102-DDR-100F18	
100	35	144	-		140x110	105x80	13.5x11	450	450	4107-DDB-100		450	4107-DDS-100		450	4107-DDR-100	
125	40	176	48.25	-	140x110	105x80	13.5x11	600	600	4102-DDB-125		600	4102-DDS-125		600	4102-DDR-125	
125	40	176	48.25	145	140x110	105x80	13.5x11	600	600	4102-DDB-125F17		600	4102-DDS-125F17		600	4102-DDR-125F17	
125	40	176	51	166	140x110	105x80	13.5x11	600	600	4102-DDB-125F18		600	4102-DDS-125F18		600	4102-DDR-125F18	
125	40	176	-		140x110	105x80	13.5x11	600	600	4107-DDB-125		600	4107-DDS-125		600	4107-DDR-125	
150	45	206	51.75	-	140x110	105x80	13.5x11	800	800	4102-DDB-150		800	4102-DDS-150		800	4102-DDR-150	
150	45	206	51.75	145	140x110	105x80	13.5x11	800	800	4102-DDB-150F17		800	4102-DDS-150F17		800	4102-DDR-150F17	
150	45	206	56.5	165	140x110	105x80	13.5x11	800	800	4102-DDB-150F18		800	4102-DDS-150F18		800	4102-DDR-150F18	
150	45	206	-		140x110	105x80	13.5x11	800	800	4107-DDB-150		800	4107-DDS-150		800	4107-DDR-150	
200	50	247	58	-	140x110	105x80	13.5x11	1000	1000	4102-DDB-200		1000	4102-DDS-200		1000	4102-DDR-200	
200	50	247	58	145	140x110	105x80	13.5x11	1000	1000	4102-DDB-200F17		1000	4102-DDS-200F17		1000	4102-DDR-200F17	
200	50	247	60	162	140x110	105x80	13.5x11	1000	1000	4102-DDB-200F18		1000	4102-DDS-200F18		1000	4102-DDR-200F18	
200	50	249	-	-	140x110	105x80	13.5x11	1000	1000	4107-DDB-200		1000	4107-DDS-200		1000	4107-DDR-200	

											DÖKÜM ÜZERİ VULKANİZE LASTİK KAPLI BURÇLU			DÖKÜM ÜZERİ VULKANİZE LASTİK KAPLI MASURALI			DÖKÜM ÜZERİ VULKANİZE LASTİK KAPLI RULMANLI
mm	mm	mm	mm	mm	mm	mm	mm	mm	kg	DVB		kg	DVS		kg	DYR	
80	30	116	40	-	105x80	80x60	12x9	90	90	4102-DVB-080		90	4102-DVS-080		90	4102-DYR-080	
80	30	116	40	121	105x80	80x60	12x9	90	90	4102-DVB-080F18		90	4102-DVS-080F18		90	4102-DYR-080F18	
80	30	116			105x80	80x60	12x9	90	90	4107-DVB-080		90	4107-DVS-080		90	4107-DYR-080	
100	35	144	46.5	-	140x110	105x80	13.5x11	140	140	4102-DVB-100		140	4102-DVS-100		140	4102-DYR-100	
100	35	144	46.5	145	140x110	105x80	13.5x11	140	140	4102-DVB-100F17		140	4102-DVS-100F17		140	4102-DYR-100F17	
100	35	144	50.5	163	140x110	105x80	13.5x11	140	140	4102-DVB-100F18		140	4102-DVS-100F18		140	4102-DYR-100F18	
100	35	144	-		140x110	105x80	13.5x11	140	140	4107-DVB-100		140	4107-DVS-100		140	4107-DYR-100	
125	40	176	48.25	-	140x110	105x80	13.5x11	180	180	4102-DVB-125		180	4102-DVS-125		180	4102-DYR-125	
125	40	176	48.25	145	140x110	105x80	13.5x11	180	180	4102-DVB-125F17		180	4102-DVS-125F17		180	4102-DYR-125F17	
125	40	176	51	166	140x110	105x80	13.5x11	180	180	4102-DVB-125F18		180	4102-DVS-125F18		180	4102-DYR-125F18	
125	40	176	-		140x110	105x80	13.5x11	180	180	4107-DVB-125		180	4107-DVS-125		180	4107-DYR-125	
150	45	206	51.75	-	140x110	105x80	13.5x11	200	200	4102-DVB-150		200	4102-DVS-150		200	4102-DYR-150	
150	45	206	51.75	145	140x110	105x80	13.5x11	200	200	4102-DVB-150F17		200	4102-DVS-150F17		200	4102-DYR-150F17	
150	45	206	56.5	165	140x110	105x80	13.5x11	200	200	4102-DVB-150F18		200	4102-DVS-150F18		200	4102-DYR-150F18	
150	45	206	-		140x110	105x80	13.5x11	200	200	4107-DVB-150		200	4107-DVS-150		200	4107-DYR-150	
170	45	216	51.75	-	140x110	105x80	13.5x11	-	-	-		-	-		240	4102-DYR-170	
170	45	216	51.75	145	140x110	105x80	13.5x11	-	-	-		-	-		240	4102-DYR-170F17	
170	45	216	51.75	144	140x110	105x80	13.5x11	-	-	-		-	-		240	4102-DYR-170F09	
170	45	216	-	-	140x110	105x80	13.5x11	-	-	-		-	-		240	4107-DYR-170	
200	50	247	58	-	140x110	105x80	13.5x11	320	320	4102-DVB-200		320	4102-DVS-200		320	4102-DYR-200	
200	50	247	58	145	140x110	105x80	13.5x11	320	320	4102-DVB-200F17		320	4102-DVS-200F17		320	4102-DYR-200F17	
200	50	247	60	162	140x110	105x80	13.5x11	320	320	4102-DVB-200F18		320	4102-DVS-200F18		320	4102-DYR-200F18	
200	50	249	-	-	140x110	105x80	13.5x11	320	320	4107-DVB-200		320	4107-DVS-200		320	4107-DYR-200	

											DÖKÜM ÜZERİ DÖKME POLİÜRETAN KAPLI RULMANLI			DÖKÜM ÜZERİ RADYÜSLÜ DÖKME POLİÜRETAN KAPLI RULMANLI			KAMALON ÜZERİ DÖKME POLİÜRETAN KAPLI RULMANLI
80	30	116	40		105x80	80x60	12x9	200		4102-DOR-080	-		-	-	-	-	-
80	30	116	40	121	105x80	80x60	12x9	200		4102-DOR-080F18	-		-	-	-	-	-
80	30	116			105x80	80x60	12x9	200		4107-DOR-080	-		-	-	-	-	-
100	35	144	46.5	-	140x110	105x80	13.5x11	450		4102-DOR-100	450		4102-D2OR-100	-	-	-	-
100	35	144	46.5	145	140x110	105x80	13.5x11	450		4102-DOR-100F17	450		4102-D2OR-100F17	-	-	-	-
100	35	144	50.5	163	140x110	105x80	13.5x11	450		4102-DOR-100F18	450		4102-D2OR-100F18	-	-	-	-
100	35	144	-		140x110	105x80	13.5x11	450		4107-DOR-100	450		4107-D2OR-100	-	-	-	-
125	40	176	48.25	-	140x110	105x80	13.5x11	600		4102-DOR-125	550		4102-D2OR-125	-	-	-	-
125	40	176	48.25	145	140x110	105x80	13.5x11	600		4102-DOR-125F17	550		4102-D2OR-125F17	-	-	-	-
125	40	176	51	166	140x110	105x80	13.5x11	600		4102-DOR-125F18	550		4102-D2OR-125F18	-	-	-	-
125	40	176	-		140x110	105x80	13.5x11	600		4107-DOR-125	550		4107-D2OR-125	-	-	-	-
150	45	206	51.75	-	140x110	105x80	13.5x11	800		4102-DOR-150	800		4102-D2OR-150	-	-	-	-
150	45	206	51.75	145	140x110	105x80	13.5x11	800		4102-DOR-150F17	800		4102-D2OR-150F17	-	-	-	-
150	45	206	56.5	165	140x110	105x80	13.5x11	800		4102-DOR-150F18	800		4102-D2OR-150F18	-	-	-	-
150	45	206	-		140x110	105x80	13.5x11	800		4107-DOR-150	800		4107-D2OR-150	-	-	-	-
150	50	206	51.75	-	140x110	105x80	13.5x11	-		-	-		-	700		4102-KOR-150	
150	50	206	51.75	145	140x110	105x80	13.5x11	-		-	-		-	700		4102-KOR-150F17	
150	50	206	56.5	165	140x110	105x80	13.5x11	-		-	-		-	700		4102-KOR-150F18	
150	50	206	-		140x110	105x80	13.5x11	-		-	-		-	700		4107-KOR-150	
160	50	202	61	-	140x110	105x80	13.5x11	-		-	-		-	700		4102-KOR-160	
160	50	202	61	145	140x110	105x80	13.5x11	-		-	-		-	700		4102-KOR-160F17	
160	50	204	58	161	140x110	105x80	13.5x11	-		-	-		-	700		4102-KOR-160F18	
160	50	205	-		140x110	105x80	13.5x11	-		-	-		-	700		4107-KOR-160	
200	50	247	58	-	140x110	105x80	13.5x11	1200		4102-DOR-200	1200		4102-D2OR-200	1000		4102-KOR-200	
200	50	247	58	145	140x110	105x80	13.5x11	1200		4102-DOR-200F17	1200		4102-D2OR-200F17	1000		4102-KOR-200F17	
200	50	247	60	162	140x110	105x80	13.5x11	1200		4102-DOR-200F18	1200		4102-D2OR-200F18	1000		4102-KOR-200F18	
200	50	249	-	-	140x110	105x80	13.5x11	1200		4107-DOR-200	1200		4107-D2OR-200	1000		4107-KOR-200	

											KAMALON ÜZERİ RADIÜSLÜ DÖKME POLİÜRETAN KAPLI RULMANLI			KAMALON ÜZERİ ENJ. POLİÜRETAN KAPLI RULMANLI			KAMALON ÜZERİ LASTİK KAPLI RULMANLI
150	50	206	51.75	-	140x110	105x80	13.5x11	700		4102-K2OR-150	700		4102-KUR150	-	-	-	-
150	50	206	51.75	145	140x110	105x80	13.5x11	700		4102-K2OR-150F17	700		4102-KUR-150F17	-	-	-	-
150	50	206	56.5	165	140x110	105x80	13.5x11	700		4102-K2OR-150F18	700		4102-KUR-150F18	-	-	-	-
150	50	206			140x110	105x80	13.5x11	700		4107-K2OR-150	700		4107-KUR-150	-	-	-	-
160	50	202	61	-	140x110	105x80	13.5x11	700		4102-K2OR-160	700		4102-KUR-160	-	-	-	-
160	50	202	61	145	140x110	105x80	13.5x11	700		4102-K2OR-160F17	700		4102-KUR-160F17	-	-	-	-
160	50	204	58	161	140x110	105x80	13.5x11	700		4102-K2OR-160F18	700		4102-KUR-160F18	-	-	-	-
160	50	205	-		140x110	105x80	13.5x11	700		4107-K2OR-160	700		4107-KUR-160	-	-	-	-
200	50	247	58	-	140x110	105x80	13.5x11	1000		4102-K2OR-200	1000		4102-KUR-200	320		4102-KYR-200	
200	50	247	58	145	140x110	105x80	13.5x11	1000		4102-K2OR-200F17	1000		4102-KUR-200F17	320		4102-KYR-200F17	
200	50	247	60	162	140x110	105x80	13.5x11	1000		4102-K2OR-200F18	1000		4102-KUR-200F18	320		4102-KYR-200F18	
200	50	249	-	-	140x110	105x80	13.5x11	1000		4107-K2OR-200	1000		4107-KUR-200	320		4107-KYR-200	



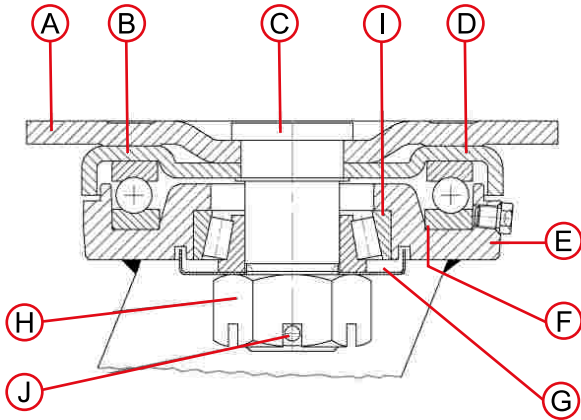
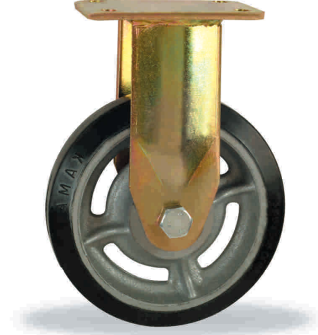









4300 Serisi



























AĞIR SANAYİ TİPİ DÖNER RULETLER













- A:** Hidrolik preste formlanmış 6mm kalınlığında olan dikdörtgen tabla.
- B:** Üst bilya çanağını çepeçevre saran su ve toz ile teması engelleyen üst bilya kapağı.
- C:** Kalın tabla bağlantı civatası.
- D:** Emniyetli bir yataklama ve yüksek manevra kabiliyeti sağlayan aksel bilyalı bute rulman.
- E:** Sıcak dövmeden hassas tornalanarak imal edilmiş üst bilya çanağı.
- F:** Rulmanların yağlanması için monte edilen gresörlük.
- G:** Su-Toz gibi kirlenici ve aşındırıcı maddelerin bilya yatağına girmesini engelleyen metal toz muhafaza kapağı.
- H:** Ayarlanabilir taçlı somun.
- I:** Yüksek manevra kabiliyeti sağlayan konik rulman.
- J:** Somun emniyetinin sağlanması için monte edilen tespit gupilyası.













mm	mm	mm	mm	mm	mm	mm	mm	kg	RPR	POLİAMİD TEKER RULMANLI	kg	PUR	POLİAMİD ÜZERİ ENJ. POLİÜRETAN KAPLI RULMANLI
150	45	220	44	-	140x110	105x80	13.5x11	600	4302-RPR-150	400	4302-PUR-150		
150	45	220	44	150	140x110	105x80	13.5x11	600	4302-RPR150F09	400	4302-PUR-150F09		
150	45	220	44	145	140x110	105x80	13.5x11	600	4302-RPR-150F17	400	4302-PUR-150F17		
150	45	220	-		140x110	105x80	13.5x11	600	4307-RPR-150	400	4307-PUR-150		
200	50	265	52	-	140x110	105x80	13.5x11	900	4302-RPR-200	600	4302-PUR-200		
200	50	265	52	150	140x110	105x80	13.5x11	900	4302-RPR-200F09	600	4302-PUR-200F09		
200	50	265	52	145	140x110	105x80	13.5x11	900	4302-RPR-200F17	600	4302-PUR-200F17		
200	50	265	-		140x110	105x80	13.5x11	900	4307-RPR-200	600	4307-PUR-200		
250	60	320	64	-	140x110	105x80	13.5x11	1100	4302-RPR-250	-	-		
250	60	320	64	150	140x110	105x80	13.5x11	1100	4302-RPR-250F09	-	-		
250	60	320	64	145	140x110	105x80	13.5x11	1100	4302-RPR-250F17	-	-		
250	60	320	-		140x110	105x80	13.5x11	1100	4307-RPR-250	-	-		













 mm	 mm	 mm	 mm	 mm	 mm	 mm	 mm	 kg	 CTR CAM ELYAFLI MOBLEN ÜZERİ TERMOLASTİK KAPLI RULMANLI	 kg	 PYR POLİAMİD KASNAK ÜZERİ LASTİK KAPLI RULMANLI
150	45	220	44	-	140x110	105x80	13.5x11	180	4302-CTR-150	180	4302-PYR-150
150	45	220	44	150	140x110	105x80	13.5x11	180	4302-CTR-150F09	180	4302-PYR-150F09
150	45	220	44	145	140x110	105x80	13.5x11	180	4302-CTR-150F17	180	4302-PYR-150F17
150	45	220	-	-	140x110	105x80	13.5x11	180	4307-CTR-150	180	4307-PYR-150
200	50	265	52	-	140x110	105x80	13.5x11	250	4302-CTR-200	300	4302-PYR-200
200	50	265	52	150	140x110	105x80	13.5x11	250	4302-CTR-200F09	300	4302-PYR-200F09
200	50	265	52	145	140x110	105x80	13.5x11	250	4302-CTR-200F17	300	4302-PYR-200F17
200	50	265	-	-	140x110	105x80	13.5x11	250	4307-CTR-200	300	4307-PYR-200











 mm	 mm	 mm	 mm	 mm	 mm	 mm	 mm	 kg	 DOR DÖKÜM ÜZERİ DÖKME POLİÜRETAN KAPLI RULMANLI	 kg	 D2OR DÖKÜM ÜZERİ RADYÜSLÜ DÖKME POLİÜRETAN KAPLI RULMANLI
150	45	220	44	-	140x110	105x80	13.5x11	800	4302-DOR-150	800	4302-D2OR-150
150	45	220	44	150	140x110	105x80	13.5x11	800	4302-DOR-150F09	800	4302-D2OR-150F09
150	45	220	44	145	140x110	105x80	13.5x11	800	4302-DOR-150F17	800	4302-D2OR-150F17
150	45	220	-	-	140x110	105x80	13.5x11	800	4307-DOR-150	800	4307-D2OR-150
200	50	265	52	-	140x110	105x80	13.5x11	1200	4302-DOR-200	1200	4302-D2OR-200
200	50	265	52	150	140x110	105x80	13.5x11	1200	4302-DOR-200F09	1200	4302-D2OR-200F09
200	50	265	52	145	140x110	105x80	13.5x11	1200	4302-DOR-200F17	1200	4302-D2OR-200F17
200	50	265	-	-	140x110	105x80	13.5x11	1200	4307-DOR-200	1200	4307-D2OR-200
250	60	320	64	-	140x110	105x80	13.5x11	1400	4302-DOR-250	1400	4302-D2OR-250
250	60	320	64	150	140x110	105x80	13.5x11	1400	4302-DOR-250F09	1400	4302-D2OR-250F09
250	60	320	64	145	140x110	105x80	13.5x11	1400	4302-DOR-250F17	1400	4302-D2OR-250F17
250	60	320	-	-	140x110	105x80	13.5x11	1400	4307-DOR-250	1400	4307-D2OR-250

 mm	 mm	 mm	 mm	 mm	 mm	 mm	 mm	 kg	 KOR KAMALON KASNAK ÜZERİ DÖKME POLİÜRETAN KAPLI RULMANLI	 kg	 K2OR KAMALON KASNAK ÜZERİ RADYÜSLÜ DÖKME POLİÜRETAN KAPLI RULMANLI
150	50	220	44	-	140x110	105x80	13.5x11	700	4302-KOR-150	-	-
150	50	220	44	150	140x110	105x80	13.5x11	700	4302-KOR-150F09	-	-
150	50	220	44	145	140x110	105x80	13.5x11	700	4302-KOR-150F17	-	-
150	50	220	-	-	140x110	105x80	13.5x11	700	4307-KOR-150	-	-
160	50	225	44	-	140x110	105x80	13.5x11	700	4302-KOR-160	-	-
160	50	255	44	150	140x110	105x80	13.5x11	700	4302-KOR-160F09	-	-
160	50	255	44	145	140x110	105x80	13.5x11	700	4302-KOR-160F17	-	-
160	50	255	-	-	140x110	105x80	13.5x11	700	4307-KOR-160	-	-
200	50	265	52	-	140x110	105x80	13.5x11	1000	4302-KOR-200	1000	4302-K2OR-200
200	50	265	52	150	140x110	105x80	13.5x11	1000	4302-KOR-200F09	1000	4302-K2OR-200F09
200	50	265	52	145	140x110	105x80	13.5x11	1000	4302-KOR-200F17	1000	4302-K2OR-200F17
200	50	265	-	-	140x110	105x80	13.5x11	1000	4307-KOR-200	1000	4307-K2OR-200
250	50	320	64	-	140x110	105x80	13.5x11	1200	4302-KOR-250	1200	4302-K2OR-250
250	50	320	64	150	140x110	105x80	13.5x11	1200	4302-KOR-250F09	1200	4302-K2OR-250F09
250	50	320	64	145	140x110	105x80	13.5x11	1200	4302-KOR-250F17	1200	4302-K2OR-250F17
250	50	320	-	-	140x110	105x80	13.5x11	1200	4307-KOR-250	1200	4307-K2OR-250

 mm	 mm	 mm	 mm	 mm	 mm	 mm	 mm	 kg	 DDR DÖKÜM TEKER RULMANLI	 kg	 DYR DÖKÜM KASNAK ÜZERİ LASTİK KAPLI RULMANLI
150	45	220	44	-	140x110	105x80	13.5x11	800	4302-DDR-150	200	4302-DYR-150
150	45	220	44	150	140x110	105x80	13.5x11	800	4302-DDR-150F09	200	4302-DYR-150F09
150	45	220	44	145	140x110	105x80	13.5x11	800	4302-DDR-150F17	200	4302-DYR-150F17
150	45	220	-	-	140x110	105x80	13.5x11	800	4307-DDR-150	200	4307-DYR-150

 mm	 mm	 mm	 mm	 mm	 mm	 mm	 mm	 kg	 DDR	DÖKÜM TEKER RULMANLI	 kg	 DYR	DÖKÜM KASNAK ÜZERİ VULKANİZE LASTİK KAPLI RULMANLI
170	45	238	47		140x110	105x80	13.5x11	-		-	240	4302-DYR-170	
170	45	238	47	150	140x110	105x80	13.5x11	-		-	240	4302-DYR-170F09	
170	45	238	54.5	145	140x110	105x80	13.5x11	-		-	240	4302-DYR-170F17	
170	45	238			140x110	105x80	13.5x11	-		-	240	4307-DYR-170	
200	50	265	52		140x110	105x80	13.5x11	1000		4302-DDR-200	320	4302-DYR-200	
200	50	265	52	150	140x110	105x80	13.5x11	1000		4302-DDR-200F09	320	4302-DYR-200F09	
200	50	265	52	145	140x110	105x80	13.5x11	1000		4302-DDR-200F17	320	4302-DYR-200F17	
200	50	265			140x110	105x80	13.5x11	1000		4307-DDR-200	320	4307-DYR-200	
220	60	285	55		140x110	105x80	13.5x11	-		-	450	4302-DYR-220	
220	60	285	55	150	140x110	105x80	13.5x11	-		-	450	4302-DYR-220F09	
220	60	285	55	145	140x110	105x80	13.5x11	-		-	450	4302-DYR-220F17	
220	60	285			140x110	105x80	13.5x11	-		-	450	4307-DYR-220	
250	60	320	64		140x110	105x80	13.5x11	1400		4302-DDR-250	500	4302-DYR-250	
250	60	320	64	150	140x110	105x80	13.5x11	1400		4302-DDR-250F09	500	4302-DYR-250F09	
250	60	320	64	145	140x110	105x80	13.5x11	1400		4302-DDR-250F17	500	4302-DYR-250F17	
250	60	320			140x110	105x80	13.5x11	1400		4307-DDR-250	500	4307-DYR-250	

 mm	 mm	 mm	 mm	 mm	 mm	 mm	 mm	 kg	 ZOR	ALÜMİNYUM KASNAK ÜZERİ POLİÜRETAN KAPLI RULMANLI	 kg	 Z2OR	ALÜMİNYUM KASNAK ÜZERİ RADYÜSLÜ DÖKME POLİÜRETAN KAPLI RULMANLI
160	50	225	44	-	140x110	105x80	13.5x11	500		4302-ZOR-160	-	-	-
160	50	225	44	150	140x110	105x80	13.5x11	500		4302-ZOR-160F09	-	-	-
160	50	225	44	145	140x110	105x80	13.5x11	500		4302-ZOR-160F17	-	-	-
160	50	225			140x110	105x80	13.5x11	500		4307-ZOR-160	-	-	-
200	50	265	52	-	140x110	105x80	13.5x11	900		4302-ZOR-200	900	4302-Z2OR-200	
200	50	265	52	150	140x110	105x80	13.5x11	900		4302-ZOR-200F09	900	4302-Z2OR-200F09	
200	50	265	52	145	140x110	105x80	13.5x11	900		4302-ZOR-200F17	900	4302-Z2OR-200F17	
200	50	265			140x110	105x80	13.5x11	900		4307-ZOR-200	900	4307-Z2OR-200	
250	50	320	64	-	140x110	105x80	13.5x11	1000		4302-ZOR-250	1000	4302-Z2OR-250	
250	50	320	64	150	140x110	105x80	13.5x11	1000		4302-ZOR-250F09	1000	4302-Z2OR-250F09	
250	50	320	64	145	140x110	105x80	13.5x11	1000		4302-ZOR-250F17	1000	4302-Z2OR-250F17	
250	50	320			140x110	105x80	13.5x11	1000		4307-ZOR-250	1000	4307-Z2OR-250	

 mm	 mm	 mm	 mm	 mm	 mm	 mm	 mm	 kg	 ZYR	ALÜMİNYUM KASNAK ÜZERİ LASTİK KAPLI RULMANLI
150	45	220	44	-	140x110	105x80	13.5x11	200		4302-ZYR-150
150	45	220	44	150	140x110	105x80	13.5x11	200		4302-ZYR-150F09
150	45	220	44	145	140x110	105x80	13.5x11	200		4302-ZYR-150F17
150	45	220			140x110	105x80	13.5x11	200		4307-ZYR-150
160	50	225	44	-	140x110	105x80	13.5x11	300		4302-ZYR-160
160	50	225	44	150	140x110	105x80	13.5x11	300		4302-ZYR-160F09
160	50	225	44	145	140x110	105x80	13.5x11	300		4302-ZYR-160F17
160	50	225			140x110	105x80	13.5x11	300		4307-ZYR-160
200	50	265	52	-	140x110	105x80	13.5x11	320		4302-ZYR-200
200	50	265	52	150	140x110	105x80	13.5x11	320		4302-ZYR-200F09
200	50	265	52	145	140x110	105x80	13.5x11	320		4302-ZYR-200F17
200	50	265			140x110	105x80	13.5x11	320		4307-ZYR-200
250	50	320	64	-	140x110	105x80	13.5x11	500		4302-ZYR-250
250	50	320	64	150	140x110	105x80	13.5x11	500		4302-ZYR-250F09
250	50	320	64	145	140x110	105x80	13.5x11	500		4302-ZYR-250F17
250	50	320			140x110	105x80	13.5x11	500		4307-ZYR-250

ÖLÇÜ STANDARTLARI DIŞINDA KALAN ÜRETİMLER.

*Ø170 OLAN ÜRÜN : Tekerlek çapı olarak TS EN 12532 ölçü standardı dışındadır.





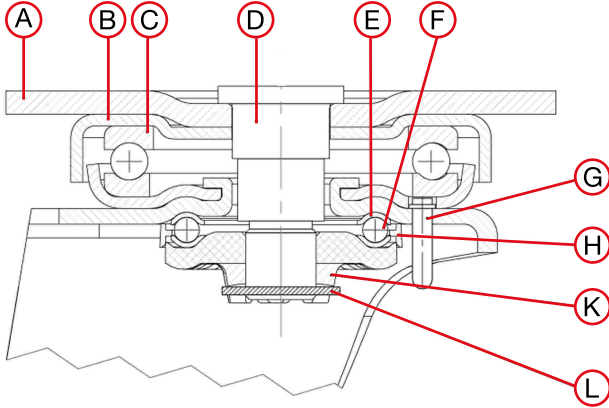
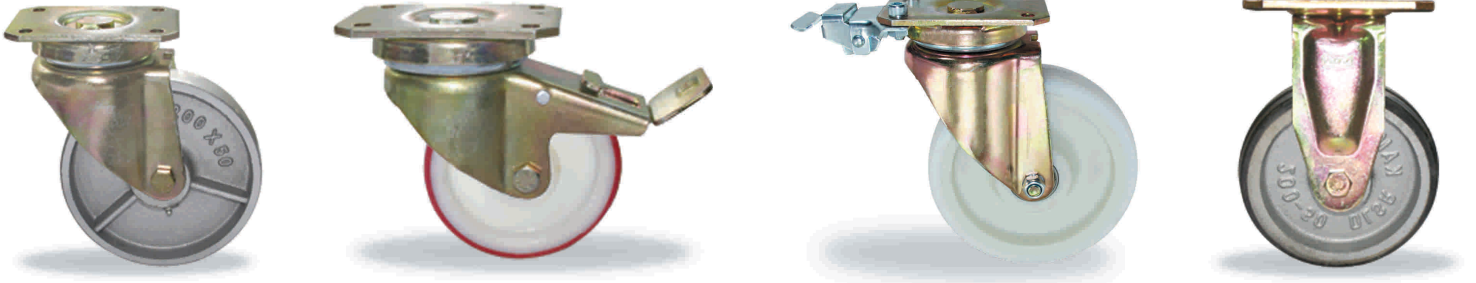







*Ø220 OLAN ÜRÜN : Tekerlek çapı olarak TS EN 12532 ölçü standardı dışındadır.













4400 Serisi



























- A:** Hidrolik preste formalanmış 6mm kalınlığında olan bağlantı tablası.
- B:** Su ve toz ile teması engelleyen üst bilya kapağı.
- C:** 51113 Büte rulman yataklamalı.
- D:** Güçlendirilmiş tabla civatası.
- E:** CK60 Malzemeden sertleştirilmiş bilya yatakları.
- F:** Alt bilya yatağı 52 HRC sertliğinde tek dizi tane bilya ile yataklanmıştır.
- G:** 360° döner maşalarda yağlanmanın yapılabilmesi için gresörlük konulmuştur.
- H:** Küresel tane bilyalar için toz muhafazası.
- K:** Yekpare alt bilya çanağı ve taç somunlu fren dişlisi.
- L:** Somun emniyetinin sağlanması için monte edilen tespit gupilyası.













mm	mm	mm	mm	mm	mm	mm	kg	BBC	BAKALİT +250 C° BURÇLU
100	35	147	46.5	140x110	105x80	13.5x11	150	4402-BBC-100	
100	35	147	-	140x110	105x80	13.5x11	150	4407-BBC-100	
125	40	181	48.25	140x110	105x80	13.5x11	300	4402-BBC-125	
125	40	181	-	140x110	105x80	13.5x11	300	4407-BBC-125	
150	45	211	51.75	140x110	105x80	13.5x11	450	4402-BBC-150	
150	45	211	-	140x110	105x80	13.5x11	450	4407-BBC-150	
200	50	253	58	140x110	105x80	13.5x11	600	4402-BBC-200	
200	50	253	-	140x110	105x80	13.5x11	600	4407-BBC-200	













 mm	 mm	 mm	 mm	 mm	 mm	 mm	 mm	 kg	 CPR	CAM ELYAFLI MOBLEN ÜZERİ POLİAMİD KAPLI RULMANLI	 kg	 CTB	CAM ELYAFLI MOBLEN ÜZERİ TERMOLASTİK KAPLI BURÇLU
100	35	147	46.5	-	140x110	105x80	13.5x11	120	4402-CPR-100		120	4402-CTB-100	
100	35	147	46.5	145	140x110	105x80	13.5x11	120	4402-CPR-100F17		120	4402-CTB-100F17	
100	35	147	50.5	163	140x110	105x80	13.5x11	120	4402-CPR-100F18		120	4402-CTB-100F18	
100	35	147	-	-	140x110	105x80	13.5x11	120	4407-CPR-100		120	4407-CTB-100	
125	40	181	48.25	-	140x110	105x80	13.5x11	140	4402-CPR-125		150	4402-CTB-125	
125	40	181	48.25	145	140x110	105x80	13.5x11	140	4402-CPR-125F17		150	4402-CTB-125F17	
125	40	181	51	166	140x110	105x80	13.5x11	140	4402-CPR-125F18		150	4402-CTB-125F18	
125	40	181	-	-	140x110	105x80	13.5x11	140	4407-CPR-125		150	4407-CTB-125	
150	45	211	51.75	-	140x110	105x80	13.5x11	170	4402-CPR-150		180	4402-CTB-150	
150	45	211	51.75	145	140x110	105x80	13.5x11	170	4402-CPR-150F17		180	4402-CTB-150F17	
150	45	211	56.5	165	140x110	105x80	13.5x11	170	4402-CPR-150F18		180	4402-CTB-150F18	
150	45	215	-	-	140x110	105x80	13.5x11	170	4407-CPR-150		180	4407-CTB-150	
200	50	253	58	-	140x110	105x80	13.5x11	240	4402-CPR-200		250	4402-CTB-200	
200	50	253	58	145	140x110	105x80	13.5x11	240	4402-CPR-200F17		250	4402-CTB-200F17	
200	50	253	60	162	140x110	105x80	13.5x11	240	4402-CPR-200F18		250	4402-CTB-200F18	
200	50	258	-	-	140x110	105x80	13.5x11	240	4407-CPR-200		250	4407-CTB-200	













 mm	 mm	 mm	 mm	 mm	 mm	 mm	 mm	 kg	 CTR	CAM ELYAFLI MOBLEN ÜZERİ TERMOLASTİK KAPLI RULMANLI	 kg	 CTS	CAM ELYAFLI MOBLEN ÜZERİ TERMOLASTİK KAPLI MASURALI
100	35	147	46.5	-	140x110	105x80	13.5x11	120	4402-CTR-100		120	4402-CTS-100	
100	35	147	46.5	145	140x110	105x80	13.5x11	120	4402-CTR-100F17		120	4402-CTS-100F17	
100	35	147	50.5	163	140x110	105x80	13.5x11	120	4402-CTR-100F18		120	4402-CTS-100F18	
100	35	147	-	-	140x110	105x80	13.5x11	120	4407-CTR-100		120	4407-CTS-100	
125	40	181	48.25	-	140x110	105x80	13.5x11	150	4402-CTR-125		150	4402-CTS-125	
125	40	181	48.25	145	140x110	105x80	13.5x11	150	4402-CTR-125F17		150	4402-CTS-125F17	
125	40	181	51	166	140x110	105x80	13.5x11	150	4402-CTR-125F18		150	4402-CTS-125F18	
125	40	181	-	-	140x110	105x80	13.5x11	150	4407-CTR-125		150	4407-CTS-125	
150	45	211	51.75	-	140x110	105x80	13.5x11	180	4402-CTR-150		180	4402-CTS-150	
150	45	211	51.75	145	140x110	105x80	13.5x11	180	4402-CTR-150F17		180	4402-CTS-150F17	
150	45	211	56.5	165	140x110	105x80	13.5x11	180	4402-CTR-150F18		180	4402-CTS-150F18	
150	45	215	-	-	140x110	105x80	13.5x11	180	4407-CTR-150		180	4407-CTS-150	
200	50	253	58	-	140x110	105x80	13.5x11	250	4402-CTR-200		250	4402-CTS-200	
200	50	253	58	145	140x110	105x80	13.5x11	250	4402-CTR-200F17		250	4402-CTS-200F17	
200	50	253	60	162	140x110	105x80	13.5x11	250	4402-CTR-200F18		250	4402-CTS-200F18	
200	50	258	-	-	140x110	105x80	13.5x11	250	4407-CTR-200		250	4407-CTS-200	











 mm	 mm	 mm	 mm	 mm	 mm	 mm	 mm	 kg	 DDB	DÖKÜM TEKER BURÇLU	 kg	 DDS	DÖKÜM TEKER MASURALI
100	35	147	46.5	-	140x110	105x80	13.5x11	450	4402-DDB-100		450	4402-DDS-100	
100	35	147	46.5	145	140x110	105x80	13.5x11	450	4402-DDB-100F17		450	4402-DDS-100F17	
100	35	147	50.5	163	140x110	105x80	13.5x11	450	4402-DDB-100F18		450	4402-DDS-100F18	
100	35	147	-	-	140x110	105x80	13.5x11	450	4407-DDB-100		450	4407-DDS-100	
125	40	181	48.25	-	140x110	105x80	13.5x11	600	4402-DDB-125		600	4402-DDS-125	
125	40	181	48.25	145	140x110	105x80	13.5x11	600	4402-DDB-125F17		600	4402-DDS-125F17	
125	40	181	51	166	140x110	105x80	13.5x11	600	4402-DDB-125F18		600	4402-DDS-125F18	
125	40	181	-	-	140x110	105x80	13.5x11	600	4407-DDB-125		600	4407-DDS-125	













 mm	 mm	 mm	 mm	 mm	 mm	 mm	 mm	 kg	 DDB	DÖKÜM TEKER BURÇLU	 kg	 DDS	DÖKÜM TEKER MASURALI
150	45	211	51.75	-	140x110	105x80	13.5x11	800	4402-DDB-150	800	4402-DDS-150		
150	45	211	51.75	145	140x110	105x80	13.5x11	800	4402-DDB-150F17	800	4402-DDS-150F17		
150	45	211	56.5	165	140x110	105x80	13.5x11	800	4402-DDB-150F18	800	4402-DDS-150F18		
150	45	215	-	-	140x110	105x80	13.5x11	800	4407-DDB-150	800	4407-DDS-150		
200	50	253	58	-	140x110	105x80	13.5x11	1000	4402-DDB-200	1000	4402-DDS-200		
200	50	253	58	145	140x110	105x80	13.5x11	1000	4402-DDB-200F17	1000	4402-DDS-200F17		
200	50	253	60	162	140x110	105x80	13.5x11	1000	4402-DDB-200F18	1000	4402-DDS-200F18		
200	50	258	-	-	140x110	105x80	13.5x11	1000	4407-DDB-200	1000	4407-DDS-200		













 mm	 mm	 mm	 mm	 mm	 mm	 mm	 mm	 kg	 DDR	DÖKÜM TEKER RULMANLI	 kg	 DOR	DÖKÜM ÜZERİ DÖKME POLİÜRETAN KAPLI RULMANLI
100	35	147	46.5	-	140x110	105x80	13.5x11	450	4402-DDR-100	450	4402-DOR-100		
100	35	147	46.5	145	140x110	105x80	13.5x11	450	4402-DDR-100F17	450	4402-DOR-100F17		
100	35	147	50.5	163	140x110	105x80	13.5x11	450	4402-DDR-100F18	450	4402-DOR-100F18		
100	35	147	-	-	140x110	105x80	13.5x11	450	4407-DDR-100	450	4407-DOR-100		
125	40	181	48.25	-	140x110	105x80	13.5x11	600	4402-DDR-125	600	4402-DOR-125		
125	40	181	48.25	145	140x110	105x80	13.5x11	600	4402-DDR-125F17	600	4402-DOR-125F17		
125	40	181	51	166	140x110	105x80	13.5x11	600	4402-DDR-125F18	600	4402-DOR-125F18		
125	40	181	-	-	140x110	105x80	13.5x11	600	4407-DDR-125	600	4407-DOR-125		
150	45	211	51.75	-	140x110	105x80	13.5x11	800	4402-DDR-150	800	4402-DOR-150		
150	45	211	51.75	145	140x110	105x80	13.5x11	800	4402-DDR-150F17	800	4402-DOR-150F17		
150	45	211	56.5	165	140x110	105x80	13.5x11	800	4402-DDR-150F18	800	4402-DOR-150F18		
150	45	215	-	-	140x110	105x80	13.5x11	800	4407-DDR-150	800	4407-DOR-150		
200	50	253	58	-	140x110	105x80	13.5x11	1000	4402-DDR-200	1200	4402-DOR-200		
200	50	253	58	145	140x110	105x80	13.5x11	1000	4402-DDR-200F17	1200	4402-DOR-200F17		
200	50	253	60	162	140x110	105x80	13.5x11	1000	4402-DDR-200F18	1200	4402-DOR-200F18		
200	50	258	-	-	140x110	105x80	13.5x11	1000	4407-DDR-200	1200	4407-DOR-200		













 mm	 mm	 mm	 mm	 mm	 mm	 mm	 mm	 kg	 D2OR	DÖKÜM ÜZERİ RADIÜSLÜ DÖKME POLİÜRETAN KAPLI RULMANLI	 kg	 DVB	DÖKÜM ÜZERİ VULKANİZE LASTİK KAPLI BURÇLU
100	35	147	46.5	-	140x110	105x80	13.5x11	450	4402-D2OR-100	140	4402-DVB-100		
100	35	147	46.5	145	140x110	105x80	13.5x11	450	4402-D2OR-100F17	140	4402-DVB-100F17		
100	35	147	50.5	163	140x110	105x80	13.5x11	450	4402-D2OR-100F18	140	4402-DVB-100F18		
100	35	147	-	-	140x110	105x80	13.5x11	450	4407-D2OR-100	140	4407-DVB-100		
125	40	181	48.25	-	140x110	105x80	13.5x11	600	4402-D2OR-125	180	4402-DVB-125		
125	40	181	48.25	145	140x110	105x80	13.5x11	600	4402-D2OR-125F17	180	4402-DVB-125F17		
125	40	181	51	166	140x110	105x80	13.5x11	600	4402-D2OR-125F18	180	4402-DVB-125F18		
125	40	181	-	-	140x110	105x80	13.5x11	600	4407-D2OR-125	180	4407-DVB-125		
150	45	211	51.75	-	140x110	105x80	13.5x11	800	4402-D2OR-150	200	4402-DVB-150		
150	45	211	51.75	145	140x110	105x80	13.5x11	800	4402-D2OR-150F17	200	4402-DVB-150F17		
150	45	211	56.5	165	140x110	105x80	13.5x11	800	4402-D2OR-150F18	200	4402-DVB-150F18		
150	45	215	-	-	140x110	105x80	13.5x11	800	4407-D2OR-150	200	4407-DVB-150		
200	50	253	58	-	140x110	105x80	13.5x11	1200	4402-DDR-200	320	4402-DVB-200		
200	50	253	58	145	140x110	105x80	13.5x11	1200	4402-DDR-200F17	320	4402-DVB-200F17		
200	50	253	60	162	140x110	105x80	13.5x11	1200	4402-DDR-200F18	320	4402-DVB-200F18		
200	50	258	-	-	140x110	105x80	13.5x11	1200	4407-DDR-200	320	4407-DVB-200		













 mm	 mm	 mm	 mm	 mm	 mm	 mm	 mm	 kg	 DVS	DÖKÜM ÜZERİ VULKANİZE LASTİK KAPLI MASURALI	 kg	 DYR	DÖKÜM ÜZERİ VULKANİZE LASTİK KAPLI RULMANLI
100	35	147	46.5	-	140x110	105x80	13.5x11	140	4402-DVS-100		140	4402-DYR-100	
100	35	147	46.5	145	140x110	105x80	13.5x11	140	4402-DVS-100F17		140	4402-DYR-100F17	
100	35	147	50.5	163	140x110	105x80	13.5x11	140	4402-DVS-100F18		140	4402-DYR-100F18	
100	35	147	-	-	140x110	105x80	13.5x11	140	4407-DVS-100		140	4407-DYR-100	
125	40	181	48.25	-	140x110	105x80	13.5x11	180	4402-DVS-125		180	4402-DYR-125	
125	40	181	48.25	145	140x110	105x80	13.5x11	180	4402-DVS-125F17		180	4402-DYR-125F17	
125	40	181	51	166	140x110	105x80	13.5x11	180	4402-DVS-125F18		180	4402-DYR-125F18	
125	40	181	-	-	140x110	105x80	13.5x11	180	4407-DVS-125		180	4407-DYR-125	
150	45	211	51.75	-	140x110	105x80	13.5x11	200	4402-DVS-150		200	4402-DYR-150	
150	45	211	51.75	145	140x110	105x80	13.5x11	200	4402-DVS-150F17		200	4402-DYR-150F17	
150	45	211	56.5	165	140x110	105x80	13.5x11	200	4402-DVS-150F18		200	4402-DYR-150F18	
150	45	215	-	-	140x110	105x80	13.5x11	200	4407-DVS-150		200	4407-DYR-150	
200	50	253	58	-	140x110	105x80	13.5x11	320	4402-DVS-200		320	4402-DYR-200	
200	50	253	58	145	140x110	105x80	13.5x11	320	4402-DVS-200F17		320	4402-DYR-200F17	
200	50	253	60	162	140x110	105x80	13.5x11	320	4402-DVS-200F18		320	4402-DYR-200F18	
200	50	258	-	-	140x110	105x80	13.5x11	320	4407-DVS-200		320	4407-DYR-200	













 mm	 mm	 mm	 mm	 mm	 mm	 mm	 mm	 kg	 KOR	KAMALON ÜZERİ DÖKME POLİÜRETAN KAPLI RULMANLI	 kg	 K2OR	KAMALON ÜZERİ DÖKME RADYÜSLÜ POLİÜRETAN KAPLI RULMANLI
150	50	211	51.75	-	140x110	105x80	13.5x11	700	4402-KOR-150				
150	50	211	51.75	145	140x110	105x80	13.5x11	700	4402-KOR-150F17				
150	50	211	56.5	165	140x110	105x80	13.5x11	700	4402-KOR-150F18				
150	50	215	-	-	140x110	105x80	13.5x11	700	4407-KOR-150				
160	50	207	61	-	140x110	105x80	13.5x11	700	4402-KOR-160				
160	50	207	61	145	140x110	105x80	13.5x11	700	4402-KOR-160F17				
160	50	207	58	161	140x110	105x80	13.5x11	700	4402-KOR-160F18				
160	50	207	-	-	140x110	105x80	13.5x11	700	4407-KOR-160				
200	50	253	58	-	140x110	105x80	13.5x11	1000	4402-KOR-200		1000	4402-K2OR-200	
200	50	253	58	145	140x110	105x80	13.5x11	1000	4402-KOR-200F17		1000	4402-K2OR-200F17	
200	50	253	60	162	140x110	105x80	13.5x11	1000	4402-KOR-200F18		1000	4402-K2OR-200F18	
200	50	258	-	-	140x110	105x80	13.5x11	1000	4407-KOR-200		1000	4407-K2OR-200	













 mm	 mm	 mm	 mm	 mm	 mm	 mm	 mm	 kg	 KPR	KAMALON ÜZERİ POLİAMİD KAPLI RULMANLI	 kg	 KUR	KAMALON ÜZERİ ENJ. POLİÜRETAN KAPLI RULMANLI
150	50	211	51.75	-	140x110	105x80	13.5x11	600	4402-KPR-150		700	4402-KUR-150	
150	50	211	51.75	145	140x110	105x80	13.5x11	600	4402-KPR-150F17		700	4402-KUR-1250F17	
150	50	211	56.5	165	140x110	105x80	13.5x11	600	4402-KPR-150F18		700	4402-KUR-150F18	
150	50	215	-	-	140x110	105x80	13.5x11	600	4407-KPR-150		700	4407-KUR-150	
160	50	207	61	-	140x110	105x80	13.5x11	600	4402-KPR-160		700	4402-KUR-160	
160	50	207	61	145	140x110	105x80	13.5x11	600	4402-KPR-160F17		700	4402-KUR-160F17	
160	50	207	58	161	140x110	105x80	13.5x11	600	4402-KPR-160F18		700	4402-KUR-160F18	
160	50	207	-	-	140x110	105x80	13.5x11	600	4407-KPR-160		700	4407-KUR-160	
200	50	253	58	-	140x110	105x80	13.5x11	900	4402-KPR-200		1000	4402-KUR-200	
200	50	253	58	145	140x110	105x80	13.5x11	900	4402-KPR-200F17		1000	4402-KUR-200F17	
200	50	253	60	162	140x110	105x80	13.5x11	900	4402-KPR-200F18		1000	4402-KUR-200F18	
200	50	258	-	-	140x110	105x80	13.5x11	900	4407-KPR-200		1000	4407-KUR-200	











 mm	 mm	 mm	 mm	 mm	 mm	 mm	 mm	 kg	 PUB	POLİAMİD ÜZERİ POLİÜRETAN KAPLI BURÇLU	 kg	 PUR	POLİAMİD ÜZERİ POLİÜRETAN KAPLI RULMANLI
100	35	147	46.5	-	140x110	105x80	13.5x11	160	4402-PUB-100	160	4402-PUR-100		
100	35	147	46.5	145	140x110	105x80	13.5x11	160	4402-PUB-100F17	160	4402-PUR-100F17		
100	35	147	50.5	163	140x110	105x80	13.5x11	160	4402-PUB-100F18	160	4402-PUR-100F18		
100	35	147	-	-	140x110	105x80	13.5x11	160	4407-PUB-100	160	4407-PUR-100		
125	40	181	48.25	-	140x110	105x80	13.5x11	250	4402-PUB-125	250	4402-PUR-125		
125	40	181	48.25	145	140x110	105x80	13.5x11	250	4402-PUB-125F17	250	4402-PUR-125F17		
125	40	181	51	166	140x110	105x80	13.5x11	250	4402-PUB-125F18	250	4402-PUR-125F18		
125	40	181	-	-	140x110	105x80	13.5x11	250	4407-PUB-125	250	4407-PUR-125		
150	45	211	51.75	-	140x110	105x80	13.5x11	400	4402-PUB-150	400	4402-PUR-150		
150	45	211	51.75	145	140x110	105x80	13.5x11	400	4402-PUB-150F17	400	4402-PUR-150F17		
150	45	211	56.5	165	140x110	105x80	13.5x11	400	4402-PUB-150F18	400	4402-PUR-150F18		
150	45	215	-	-	140x110	105x80	13.5x11	400	4407-PUB-150	400	4407-PUR-150		
200	50	253	58	-	140x110	105x80	13.5x11	600	4402-PUB-200	600	4402-PUR-200		
200	50	253	58	145	140x110	105x80	13.5x11	600	4402-PUB-200F17	600	4402-PUR-200F17		
200	50	253	60	162	140x110	105x80	13.5x11	600	4402-PUB-200F18	600	4402-PUR-200F18		
200	50	258	-	-	140x110	105x80	13.5x11	600	4407-PUB-200	600	4407-PUR-200		













 mm	 mm	 mm	 mm	 mm	 mm	 mm	 mm	 kg	 PUS	POLİAMİD ÜZERİ POLİÜRETAN KAPLI MASURALI	 kg	 PYB	POLİAMİD ÜZERİ VULKANİZE LASTİK KAPLI BURÇLU
100	35	147	46.5	-	140x110	105x80	13.5x11	160	4402-PUS-100	120	4402-PYB-100		
100	35	147	46.5	145	140x110	105x80	13.5x11	160	4402-PUS-100F17	120	4402-PYB-100F17		
100	35	147	50.5	163	140x110	105x80	13.5x11	160	4402-PUS-100F18	120	4402-PYB-100F18		
100	35	147	-	-	140x110	105x80	13.5x11	160	4407-PUS-100	120	4407-PYB-100		
125	40	181	48.25	-	140x110	105x80	13.5x11	250	4402-PUS-125	150	4402-PYB-125		
125	40	181	48.25	145	140x110	105x80	13.5x11	250	4402-PUS-125F17	150	4402-PYB-125F17		
125	40	181	51	166	140x110	105x80	13.5x11	250	4402-PUS-125F18	150	4402-PYB-125F18		
125	40	181	-	-	140x110	105x80	13.5x11	250	4407-PUS-125	150	4407-PYB-125		
150	45	211	51.75	-	140x110	105x80	13.5x11	400	4402-PUS-150	180	4402-PYB-150		
150	45	211	51.75	145	140x110	105x80	13.5x11	400	4402-PUS-150F17	180	4402-PYB-150F17		
150	45	211	56.5	165	140x110	105x80	13.5x11	400	4402-PUS-150F18	180	4402-PYB-150F18		
150	45	215	-	-	140x110	105x80	13.5x11	400	4407-PUS150	180	4407-PYB-150		
200	50	253	58	-	140x110	105x80	13.5x11	600	4402-PUS-200	300	4402-PYB-200		
200	50	253	58	145	140x110	105x80	13.5x11	600	4402-PUS-200F17	300	4402-PYB-200F17		
200	50	253	60	162	140x110	105x80	13.5x11	600	4402-PUS-200F18	300	4402-PYB-200F18		
200	50	258	-	-	140x110	105x80	13.5x11	600	4407-PUS-200	300	4407-PYB-200		













 mm	 mm	 mm	 mm	 mm	 mm	 mm	 mm	 kg	 PYR	POLİAMİD ÜZERİ VULKANİZE LASTİK KAPLI RULMANLI	 kg	 PYS	POLİAMİD ÜZERİ VULKANİZE LASTİK KAPLI MASURALI
100	35	147	46.5	-	140x110	105x80	13.5x11	120	4402-PYR-100	120	4402-PYS-100		
100	35	147	46.5	145	140x110	105x80	13.5x11	120	4402-PYR-100F17	120	4402-PYS-100F17		
100	35	147	50.5	163	140x110	105x80	13.5x11	120	4402-PYR-100F18	120	4402-PYS-100F18		
100	35	147	-	-	140x110	105x80	13.5x11	120	4407-PYR-100	120	4407-PYS-100		
125	40	181	48.25	-	140x110	105x80	13.5x11	150	4402-PYR-125	150	4402-PYS-125		
125	40	181	48.25	145	140x110	105x80	13.5x11	150	4402-PYR-125F17	150	4402-PYS-125F17		
125	40	181	51	166	140x110	105x80	13.5x11	150	4402-PYR-125F18	150	4402-PYS-125F18		
125	40	181	-	-	140x110	105x80	13.5x11	150	4407-PYR-125	150	4407-PYS-125		

 mm	 mm	 mm	 mm	 mm	 mm	 mm	 mm	 kg	 PYR	POLİAMİD ÜZERİ VULKANİZE LASTİK KAPLI RULMANLI	 kg	 PYS	POLİAMİD ÜZERİ VULKANİZE LASTİK KAPLI MASURALI
150	45	211	51.75	-	140x110	105x80	13.5x11	180	4402-PYR-150	180	4402-PYS-150		
150	45	211	51.75	145	140x110	105x80	13.5x11	180	4402-PYR-150F17	180	4402-PYS-150F17		
150	45	211	56.5	165	140x110	105x80	13.5x11	180	4402-PYR-150F18	180	4402-PYS-150F18		
150	45	215	-	-	140x110	105x80	13.5x11	180	4407-PYR150	180	4407-PYS-150		
200	50	253	58	-	140x110	105x80	13.5x11	300	4402-PYR-200	300	4402-PYS-200		
200	50	253	58	145	140x110	105x80	13.5x11	300	4402-PYR-200F17	300	4402-PYS-200F17		
200	50	253	60	162	140x110	105x80	13.5x11	300	4402-PYR-200F18	300	4402-PYS-200F18		
200	50	258	-	-	140x110	105x80	13.5x11	300	4407-PYR-200	300	4407-PYS-200		

 mm	 mm	 mm	 mm	 mm	 mm	 mm	 mm	 kg	 RPB	POLİAMİD TEKER BURÇLU	 kg	 RPR	POLİAMİD TEKER RULMANLI
100	35	147	46.5	-	140x110	105x80	13.5x11	400	4402-RPB-100	400	4402-RPR-100		
100	35	147	46.5	145	140x110	105x80	13.5x11	400	4402-RPB-100F17	400	4402-RPR-100F17		
100	35	147	50.5	163	140x110	105x80	13.5x11	400	4402-RPB-100F18	400	4402-RPR-100F18		
100	35	147	-	-	140x110	105x80	13.5x11	400	4407-RPB-100	400	4407-RPR-100		
125	40	181	48.25	-	140x110	105x80	13.5x11	500	4402-RPB-125	500	4402-RPR-125		
125	40	181	48.25	145	140x110	105x80	13.5x11	500	4402-RPB-125F17	500	4402-RPR-125F17		
125	40	181	51	166	140x110	105x80	13.5x11	500	4402-RPB-125F18	500	4402-RPR-125F18		
125	40	181	-	-	140x110	105x80	13.5x11	500	4407-RPB-125	500	4407-RPR-125		
150	45	211	51.75	-	140x110	105x80	13.5x11	600	4402-RPB-150	600	4402-RPR-150		
150	45	211	51.75	145	140x110	105x80	13.5x11	600	4402-RPB-150F17	600	4402-RPR-150F17		
150	45	211	56.5	165	140x110	105x80	13.5x11	600	4402-RPB-150F18	600	4402-RPR-150F18		
150	45	215	-	-	140x110	105x80	13.5x11	600	4407-RPB-150	600	4407-RPR-150		
200	50	253	58	-	140x110	105x80	13.5x11	900	4402-RPB-200	900	4402-RPR-200		
200	50	253	58	145	140x110	105x80	13.5x11	900	4402-RPB-200F17	900	4402-RPR-200F17		
200	50	253	60	162	140x110	105x80	13.5x11	900	4402-RPB-200F18	900	4402-RPR-200F18		
200	50	258	-	-	140x110	105x80	13.5x11	900	4407-RPB-200	900	4407-RPR-200		

 mm	 mm	 mm	 mm	 mm	 mm	 mm	 mm	 kg	 RPS	POLİAMİD TEKER MASURALI
100	35	147	46.5	-	140x110	105x80	13.5x11	400	4402-RPS-100	
100	35	147	46.5	145	140x110	105x80	13.5x11	400	4402-RPS-100F17	
100	35	147	50.5	163	140x110	105x80	13.5x11	400	4402-RPS-100F18	
100	35	147	-	-	140x110	105x80	13.5x11	400	4407-RPS-100	
125	40	181	48.25	-	140x110	105x80	13.5x11	500	4402-RPS-125	
125	40	181	48.25	145	140x110	105x80	13.5x11	500	4402-RPS-125F17	
125	40	181	51	166	140x110	105x80	13.5x11	500	4402-RPS-125F18	
125	40	181	-	-	140x110	105x80	13.5x11	500	4407-RPS-125	
150	45	211	51.75	-	140x110	105x80	13.5x11	600	4402-RPS-150	
150	45	211	51.75	145	140x110	105x80	13.5x11	600	4402-RPS-150F17	
150	45	211	56.5	165	140x110	105x80	13.5x11	600	4402-RPS-150F18	
150	45	215	-	-	140x110	105x80	13.5x11	600	4407-RPS-150	
200	50	253	58	-	140x110	105x80	13.5x11	900	4402-RPS-200	
200	50	253	58	145	140x110	105x80	13.5x11	900	4402-RPS-200F17	
200	50	253	60	162	140x110	105x80	13.5x11	900	4402-RPS-200F18	
200	50	258	-	-	140x110	105x80	13.5x11	900	4407-RPS-200	

 mm	 mm	 mm	 mm	 mm	 mm	 mm	 mm	 kg	 ZOR	ALÜMİNYUM ÜZERİ DÖKME POLİÜRETAN KAPLI RULMANLI	 kg	 Z2OR	ALÜMİNYUM ÜZERİ RADYÜSLÜ DÖKME POLİÜRETAN KAPLI RULMANLI
125	45	181	48.25	-	140x110	105x80	13.5x11	350	4402-ZOR-125	-	-	-	-
125	45	181	48.25	145	140x110	105x80	13.5x11	350	4402-ZOR-125F17	-	-	-	-
125	45	181	51	166	140x110	105x80	13.5x11	350	4402-ZOR-15F18	-	-	-	-
125	45	181	-	-	140x110	105x80	13.5x11	350	4407-ZOR-125	-	-	-	-
160	50	207	61	-	140x110	105x80	13.5x11	500	4402-ZOR-160	-	-	-	-
160	50	207	61	145	140x110	105x80	13.5x11	500	4402-ZOR-160F17	-	-	-	-
160	50	207	58	161	140x110	105x80	13.5x11	500	4402-ZOR-160F18	-	-	-	-
160	50	207	-	-	140x110	105x80	13.5x11	500	4407-ZOR-160	-	-	-	-
200	50	253	58	-	140x110	105x80	13.5x11	900	4402-ZOR-200	900	4402-Z2OR-200	-	-
200	50	253	58	145	140x110	105x80	13.5x11	900	4402-ZOR-200F17	900	4402-Z2OR-200F17	-	-
200	50	253	60	162	140x110	105x80	13.5x11	900	4402-ZOR-200F18	900	4402-Z2OR-200F18	-	-
200	50	258	-	-	140x110	105x80	13.5x11	900	4407-ZOR-200	900	4407-Z2OR-200	-	-

 mm	 mm	 mm	 mm	 mm	 mm	 mm	 mm	 kg	 ZYR	ALÜMİNYUM ÜZERİ LASTİK KAPLI RULMANLI	 kg	 ZER	ALÜMİNYUM ÜZERİ GRİ LASTİK KAPLI RULMANLI
100	39	147	46.5	-	140x110	105x80	13.5x11	140	4402-ZYR-100	140	4402-ZER-100	-	-
100	39	147	46.5	145	140x110	105x80	13.5x11	140	4402-ZYR-100F17	140	4402-ZER-100F17	-	-
100	39	147	50.5	163	140x110	105x80	13.5x11	140	4402-ZYR-100F18	140	4402-ZER-100F18	-	-
100	39	147	-	-	140x110	105x80	13.5x11	140	4407-ZYR-100	140	4407-ZER-100	-	-
125	39	181	48.25	-	140x110	105x80	13.5x11	170	4402-ZYR-125	170	4402-ZER-125	-	-
125	39	181	48.25	145	140x110	105x80	13.5x11	170	4402-ZYR-125F17	170	4402-ZER-125F17	-	-
125	39	181	51	166	140x110	105x80	13.5x11	170	4402-ZYR-125F18	170	4402-ZER-125F18	-	-
125	39	181	-	-	140x110	105x80	13.5x11	170	4407-ZYR-125	170	4407-ZER-125	-	-
150	45	211	51.75	-	140x110	105x80	13.5x11	200	4402-ZYR-150	200	4402-ZER-150	-	-
150	45	211	51.75	145	140x110	105x80	13.5x11	200	4402-ZYR-150F17	200	4402-ZER-150F17	-	-
150	45	211	56.5	165	140x110	105x80	13.5x11	200	4402-ZYR-150F18	200	4402-ZER-150F18	-	-
150	45	215	-	-	140x110	105x80	13.5x11	200	4407-ZYR-150	200	4407-ZER-150	-	-
160	50	207	61	-	140x110	105x80	13.5x11	300	4402-ZYR-160	300	4402-ZER-160	-	-
160	50	207	61	145	140x110	105x80	13.5x11	300	4402-ZYR-160F17	300	4402-ZER-160F17	-	-
160	50	207	58	161	140x110	105x80	13.5x11	300	4402-ZYR-160F18	300	4402-ZER-160F18	-	-
160	50	207	-	-	140x110	105x80	13.5x11	300	4407-ZYR-160	300	4407-ZER-160	-	-
200	50	253	58	-	140x110	105x80	13.5x11	320	4402-ZYR-200	320	4402-ZER-200	-	-
200	50	253	58	145	140x110	105x80	13.5x11	320	4402-ZYR-200F17	320	4402-ZER-200F17	-	-
200	50	253	60	162	140x110	105x80	13.5x11	320	4402-ZYR-200F18	320	4402-ZER-200F18	-	-
200	50	258	-	-	140x110	105x80	13.5x11	320	4407-ZYR-200	320	4407-ZER-200	-	-

5100 Serisi

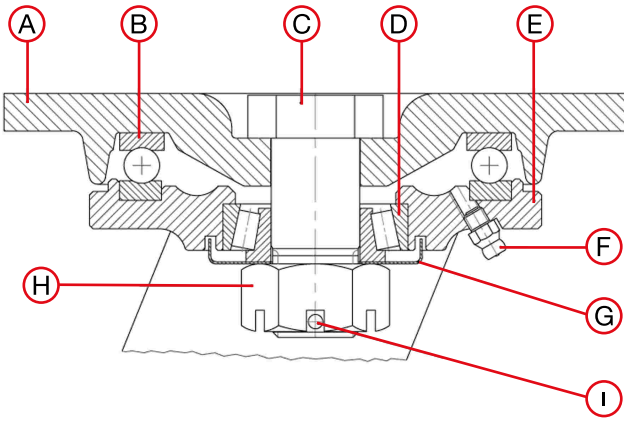
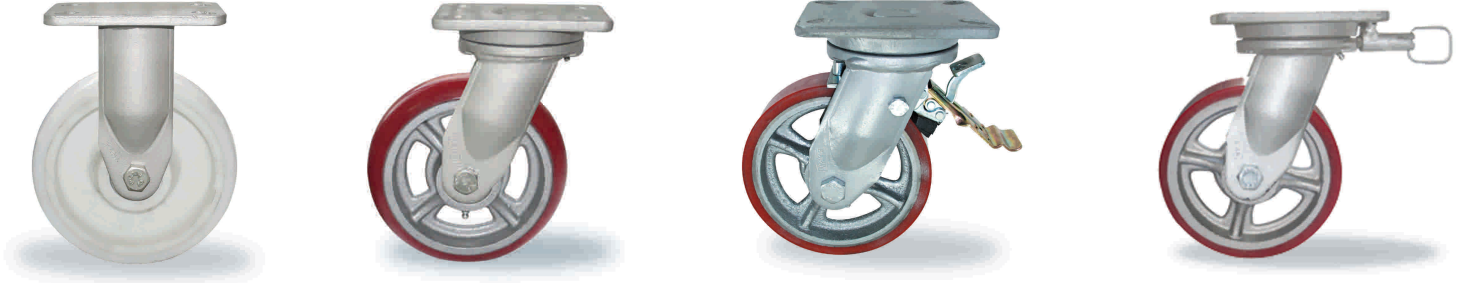

















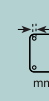







AĞIR SANAYİ TİPİ DÖNER RULETLER



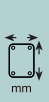

- A:** Sıcak dövmeden imal edilmiş olan 10 mm. kalınlığında dikdörtgen tabla.
- B:** Emniyetli bir yataklama ve yüksek manevra kabiliyeti sağlayan, aksenal kuvvetleri bünyesine alan büte rulman.
- C:** Kalın tabla bağlantı civatası.
- D:** Yüksek manevra kabiliyeti sağlayan konik rulman.
- E:** Sıcak dövmeden hassas tomalanarak imal edilmiş üst bilya yatağı.
- F:** Rulmanların yağlanması için monte edilen grasörlük.
- G:** Su-Toz gibi aşındırıcı maddelerin bilya yatağına girmesini engelleyen metal toz muhafaza kapağı.
- H:** Ayarlanabilir taçlı somun.
- I:** Somun emniyetinin sağlanması amacı için monte edilen tespit gupilyası.



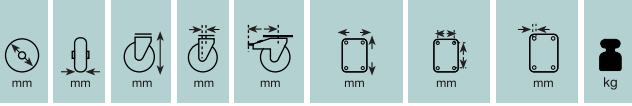

mm	mm	mm	mm	mm	mm	mm	mm	kg	RPR	POLİAMİD TEKER RULMANLI	kg	PUR	POLİAMİD ÜZERİ POLİÜRETAN KAPLI RULMANLI	kg	DOR	DÖKÜM ÜZERİ DÖKME POLİÜRETAN KAPLI RULMANLI
----	----	----	----	----	----	----	----	----	-----	-------------------------	----	-----	--	----	-----	---

150	45	220	44	-	170x140	140x105	26x15	600	5102-RPR-150	400	5102-PUR-150	800	5102-DOR-150
150	45	220	44	121.3	170x140	140x105	26x15	600	5102-RPR-150F09	400	5102-PUR-150F09	800	5102-DOR-150F09
150	45	220	44	172	170x140	140x105	26x15	600	5102-RPR-150F20	400	5102-PUR-150F20	800	5102-DOR-150F20
150	45	220			170x140	140x105	26x15	600	5107-RPR-150	400	5107-PUR-150	800	5107-DOR-150
200	50	265	52	-	170x140	140x105	26x15	900	5102-RPR-200	600	5102-PUR-200	1200	5102-DOR-200
200	50	265	52	121.3	170x140	140x105	26x15	900	5102-RPR-200F09	600	5102-PUR-200F09	1200	5102-DOR-200F09
200	50	265	52	172	170x140	140x105	26x15	900	5102-RPR-200F20	600	5102-PUR-200F20	1200	5102-DOR-200F20
200	50	265			170x140	140x105	26x15	900	5107-RPR-200	600	5107-PUR-200	1200	5107-DOR-200
250	60	320	64	-	170x140	140x105	26x15	1100	5102-RPR-250	-	-	1400	5102-DOR-250
250	60	320	64	121.3	170x140	140x105	26x15	1100	5102-RPR-250F09	-	-	1400	5102-DOR-250F09
250	60	320	64	172	170x140	140x105	26x15	1100	5102-RPR-250F20	-	-	1400	5102-DOR-250F20
250	60	320			170x140	140x105	26x15	1100	5107-RPR-250	-	-	1400	5107-DOR-250
260	65	325	64	-	170x140	140x105	26x15	-	-	-	-	1400	5102-DOR-260
260	65	325	64	121.3	170x140	140x105	26x15	-	-	-	-	1400	5102-DOR-260F09
260	65	325	64	172	170x140	140x105	26x15	-	-	-	-	1400	5102-DOR-260F20
260	65	325			170x140	140x105	26x15	-	-	-	-	1400	5107-DOR-260
270	70	349	71	-	170x140	140x105	26x15	1400	5102-RPR-270	-	-	-	-
270	70	349	71	121.3	170x140	140x105	26x15	1400	5102-RPR-270F09	-	-	-	-
270	70	349	71	172	170x140	140x105	26x15	1400	5102-RPR-270F20	-	-	-	-
270	70	349			170x140	140x105	26x15	1400	5107-RPR-270	-	-	-	-
300	70	364	71	-	170x140	140x105	26x15	-	-	-	-	1600	5102-DOR-300
300	70	364	71	121.3	170x140	140x105	26x15	-	-	-	-	1600	5102-DOR-300F09
300	70	364	71	172	170x140	140x105	26x15	-	-	-	-	1600	5102-DOR-300F20
300	70	364			170x140	140x105	26x15	-	-	-	-	1600	5107-DOR-300
350	80	412	80	-	170x140	140x105	26x15	-	-	-	-	1800	5102-DOR-350
350	80	412	80	121.3	170x140	140x105	26x15	-	-	-	-	1800	5102-DOR-350F09
350	80	412	80	172	170x140	140x105	26x15	-	-	-	-	1800	5102-DOR-350F20
350	80	412			170x140	140x105	26x15	-	-	-	-	1800	5107-DOR-350

											DÖKÜM ÜZERİ RADYÜSLÜ DÖKME POLİÜRETAN KAPLI RULMANLI			DÖKÜM TEKER RULMANLI			DÖKÜM ÜZERİ VULKANİZE LASTİK KAPLI RULMANLI
mm	mm	mm	mm	mm	mm	mm	mm	mm	kg	D2OR		kg	DDR		kg	DYR	
150	45	220	44	-	170x140	140x105	26x15	800	800	5102-D2OR-150	800	5102-DDR-150	200	5102-DYR-150			
150	45	220	44	121.3	170x140	140x105	26x15	800	800	5102-D2OR-150F09	800	5102-DDR-150F09	200	5102-DYR-150F09			
150	45	220	44	172	170x140	140x105	26x15	800	800	5102-D2OR-150F20	800	5102-DDR-150F20	200	5102-DYR-150F20			
150	45	220			170x140	140x105	26x15	800	800	5107-D2OR-150	800	5107-DDR-150	200	5107-DYR-150			
170	45	-	-	-	170x140	140x105	26x15	-	-	-	-	-	-	240	5102-DYR-170		
170	45	238	44	150	170x140	140x105	26x15	-	-	-	-	-	-	240	5102-DYR-170F09		
170	45	238	44	172	170x140	140x105	26x15	-	-	-	-	-	-	240	5102-DYR-170F20		
170	45	-	-	-	170x140	140x105	26x15	-	-	-	-	-	-	240	5107-DYR-170		
200	50	265	52	-	170x140	140x105	26x15	1200	1000	5102-D2OR-200	1000	5102-DDR-200	320	5102-DYR-200			
200	50	265	52	121.3	170x140	140x105	26x15	1200	1000	5102-D2OR-200F09	1000	5102-DDR-200F09	320	5102-DYR-200F09			
200	50	265	52	172	170x140	140x105	26x15	1200	1000	5102-D2OR-200F20	1000	5102-DDR-200F20	320	5102-DYR-200F20			
200	50	265			170x140	140x105	26x15	1200	1000	5107-D2OR-200	1000	5107-DDR-200	320	5107-DYR-200			
220	50	284	55	-	170x140	140x105	26x15	-	-	-	-	-	-	450	5102-DYR-220		
220	50	284	55	121.3	170x140	140x105	26x15	-	-	-	-	-	-	450	5102-DYR-220F09		
220	50	284	55	172	170x140	140x105	26x15	-	-	-	-	-	-	450	5102-DYR-220F20		
220	50	284			170x140	140x105	26x15	-	-	-	-	-	-	450	5107-DYR-220		
250	60	320	64	-	170x140	140x105	26x15	1400	-	5102-D2OR-250	-	-	-	500	5102-DYR-250		
250	60	320	64	121.3	170x140	140x105	26x15	1400	-	5102-D2OR-250F09	-	-	-	500	5102-DYR-250F09		
250	60	320	64	172	170x140	140x105	26x15	1400	-	5102-D2OR-250F20	-	-	-	500	5102-DYR-250F20		
250	60	320			170x140	140x105	26x15	1400	-	5107-D2OR-250	-	-	-	500	5107-DYR-250		
250	50	320	64	-	170x140	140x105	26x15	-	1400	-	-	5102-DDR-250	-	-	-	-	
250	50	320	64	121.3	170x140	140x105	26x15	-	1400	-	-	5102-DDR-250F09	-	-	-	-	
250	50	320	64	172	170x140	140x105	26x15	-	1400	-	-	5102-DDR-250F20	-	-	-	-	
250	50	320			170x140	140x105	26x15	-	1400	-	-	5107-DDR-250	-	-	-	-	
300	70	364	71	-	170x140	140x105	26x15	1600	-	5102-D2OR-300	-	-	-	600	5102-DYR-300		
300	70	364	71	121.3	170x140	140x105	26x15	1600	-	5102-D2OR-300F09	-	-	-	600	5102-DYR-300F09		
300	70	364	71	172	170x140	140x105	26x15	1600	-	5102-D2OR-300F20	-	-	-	600	5102-DYR-300F20		
300	70	364			170x140	140x105	26x15	1600	-	5107-D2OR-300	-	-	-	600	5107-DYR-300		
350	80	412	80	-	170x140	140x105	26x15	-	-	-	-	-	-	650	5102-DYR-350		
350	80	412	80	121.3	170x140	140x105	26x15	-	-	-	-	-	-	650	5102-DYR-350F09		
350	80	412	80	172	170x140	140x105	26x15	-	-	-	-	-	-	650	5102-DYR-350F20		
350	80	412			170x140	140x105	26x15	-	-	-	-	-	-	650	5107-DYR-350		
380	80	440	85	-	170x140	140x105	26x15	-	-	-	-	-	-	800	5102-DYR-380		
380	80	440	85	121.3	170x140	140x105	26x15	-	-	-	-	-	-	800	5102-DYR-380F09		
380	80	440	85	172	170x140	140x105	26x15	-	-	-	-	-	-	800	5102-DYR-380F20		
380	80	440			170x140	140x105	26x15	-	-	-	-	-	-	800	5107-DYR-380		

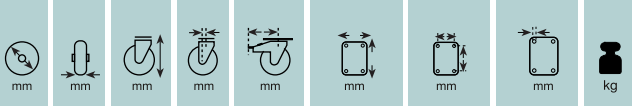
											KAMALON ÜZERİ ENJ. POLİÜRETAN KAPLI RULMANLI
mm	mm	mm	mm	mm	mm	mm	mm	mm	kg	KUR	
150	50	220	44	-	170x140	140x105	26x15	700	700	5102-KUR-150	
150	50	220	44	121.3	170x140	140x105	26x15	700	700	5102-KUR-150F09	
150	50	220	44	172	170x140	140x105	26x15	700	700	5102-KUR-150F20	
150	50	220			170x140	140x105	26x15	700	700	5107-KUR-150	
160	50	225	44	-	170x140	140x105	26x15	700	700	5102-KUR-160	
160	50	225	44	121.3	170x140	140x105	26x15	700	700	5102-KUR-160F09	
160	50	225	44	172	170x140	140x105	26x15	700	700	5102-KUR-160F20	
160	50	225			170x140	140x105	26x15	700	700	5107-KUR-160	
200	50	265	52	-	170x140	140x105	26x15	1000	1000	5102-KUR-200	
200	50	265	52	121.3	170x140	140x105	26x15	1000	1000	5102-KUR-200F09	
200	50	265	52	172	170x140	140x105	26x15	1000	1000	5102-KUR-200F20	
200	50	265			170x140	140x105	26x15	1000	1000	5107-KUR-200	

									 DÖKÜM ÜZERİ GEÇME LASTİK RULMANLI			 KAMALON ÜZERİ POLİÜRETAN KAPLI RULMANLI			 KAMALON ÜZERİ RADIÜSLÜ DÖKME POLİÜRETAN KAPLI RULMANLI		
160	50	225	44	-	170x140	140x105	26x15	-	-	700	5102-KOR-160	-	-				
160	50	225	44	121.3	170x140	140x105	26x15	-	-	700	5102-KOR-160F09	-	-				
160	50	225	44	172	170x140	140x105	26x15	-	-	700	5102-KOR-160F20	-	-				
160	50	225			170x140	140x105	26x15	-	-	700	5107-KOR-160	-	-				
200	50	265	52	-	170x140	140x105	26x15	-	-	1000	5102-KOR-200	1000	5102-K2OR-200				
200	50	265	52	121.3	170x140	140x105	26x15	-	-	1000	5102-KOR-200F09	1000	5102-K2OR-200F09				
200	50	265	52	172	170x140	140x105	26x15	-	-	1000	5102-KOR-200F20	1000	5102-K2OR-200F20				
200	50	265			170x140	140x105	26x15	-	-	1000	5107-KOR-200	1000	5107-K2OR-200				
200	60	265	52	-	170x140	140x105	26x15	380	5102-DLR-200	-	-	-	-				
200	60	265	52	121.3	170x140	140x105	26x15	380	5102-DLR-200F09	-	-	-	-				
200	60	265	52	172	170x140	140x105	26x15	380	5102-DLR-200F20	-	-	-	-				
200	60	265			170x140	140x105	26x15	380	5107-DLR-200	-	-	-	-				
220	60	284	55	-	170x140	140x105	26x15	400	5102-DLR-220	-	-	-	-				
220	60	284	55	121.3	170x140	140x105	26x15	400	5102-DLR-220F09	-	-	-	-				
220	60	284	55	172	170x140	140x105	26x15	400	5102-DLR-220F20	-	-	-	-				
220	60	284			170x140	140x105	26x15	400	5107-DLR-220	-	-	-	-				
250	50	320	64	-	170x140	140x105	26x15	-	-	1200	5102-KOR-250	1200	5102-K2OR-250				
250	50	320	64	121.3	170x140	140x105	26x15	-	-	1200	5102-KOR-250F09	1200	5102-K2OR-250F09				
250	50	320	64	172	170x140	140x105	26x15	-	-	1200	5102-KOR-250F20	1200	5102-K2OR-250F20				
250	50	320			170x140	140x105	26x15	-	-	1200	5107-KOR-250	1200	5107-K2OR-250				
300	70	364	71	-	170x140	140x105	26x15	450	5102-DLR-300	-	-	-	-				
300	70	364	71	121.3	170x140	140x105	26x15	450	5102-DLR-300F09	-	-	-	-				
300	70	364	71	172	170x140	140x105	26x15	450	5102-DLR-300F20	-	-	-	-				
300	70	364			170x140	140x105	26x15	450	5107-DLR-300	-	-	-	-				

									 ALÜMİNYUM ÜZERİ DÖKME POLİÜRETAN KAPLI RULMANLI			 ALÜMİNYUM ÜZERİ RADIÜSLÜ DÖKME POLİÜRETAN KAPLI RULMANLI			 ALÜMİNYUM ÜZERİ VULKANİZE LASTİK KAPLI RULMANLI		
150	45	220	44	-	170x140	140x105	26x15	-	-	-	-	200	5102-ZYR-150				
150	45	220	44	121.3	170x140	140x105	26x15	-	-	-	-	200	5102-ZYR-150F09				
150	45	220	44	172	170x140	140x105	26x15	-	-	-	-	200	5102-ZYR-150F20				
150	45	220			170x140	140x105	26x15	-	-	-	-	200	5107-ZYR-150				
160	50	225	44	-	170x140	140x105	26x15	500	5102-ZOR-160	-	-	-	-				
160	50	225	44	121.3	170x140	140x105	26x15	500	5102-ZOR-160F09	-	-	-	-				
160	50	225	44	172	170x140	140x105	26x15	500	5102-ZOR-160F20	-	-	-	-				
160	50	225			170x140	140x105	26x15	500	5107-ZOR-160	-	-	-	-				
200	50	265	52	-	170x140	140x105	26x15	900	5102-ZOR-200	900	5102-Z2OR-200	340	5102-ZYR-200				
200	50	265	52	121.3	170x140	140x105	26x15	900	5102-ZOR-200F09	900	5102-Z2OR-200F09	340	5102-ZYR-200F09				
200	50	265	52	172	170x140	140x105	26x15	900	5102-ZOR-200F20	900	5102-Z2OR-200F20	340	5102-ZYR-200F20				
200	50	265			170x140	140x105	26x15	900	5107-ZOR-200	900	5107-Z2OR-200	340	5107-ZYR-200				
250	50	320	64	-	170x140	140x105	26x15	1000	5102-ZOR-250	1000	5102-Z2OR-250	500	5102-ZYR-250				
250	50	320	64	121.3	170x140	140x105	26x15	1000	5102-ZOR-250F09	1000	5102-Z2OR-250F09	500	5102-ZYR-250F09				
250	50	320	64	172	170x140	140x105	26x15	1000	5102-ZOR-250F20	1000	5102-Z2OR-250F20	500	5102-ZYR-250F20				
250	50	320			170x140	140x105	26x15	1000	5107-ZOR-250	1000	5107-Z2OR-250	500	5107-ZYR-250				

ÖLÇÜ STANDARTLARI DIŞINDA KALAN ÜRETİMLER.

*Ø170 OLAN ÜRÜN : Tekerlek çapı olarak TS EN 12532 ölçü standardı dışındadır.

*Ø220 OLAN ÜRÜN : Tekerlek çapı olarak TS EN 12532 ölçü standardı dışındadır.

*Ø260 OLAN ÜRÜN : Tekerlek çapı olarak TS EN 12532 ölçü standardı dışındadır.

*Ø270 OLAN ÜRÜN : Tekerlek çapı olarak TS EN 12532 ölçü standardı dışındadır.

*Ø380 OLAN ÜRÜN : Tekerlek çapı olarak TS EN 12532 ölçü standardı dışındadır.



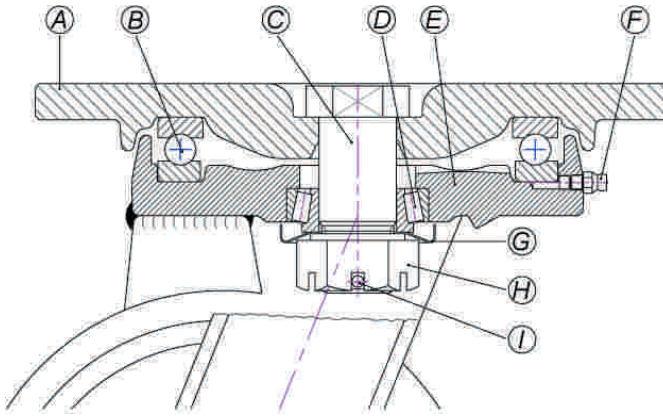





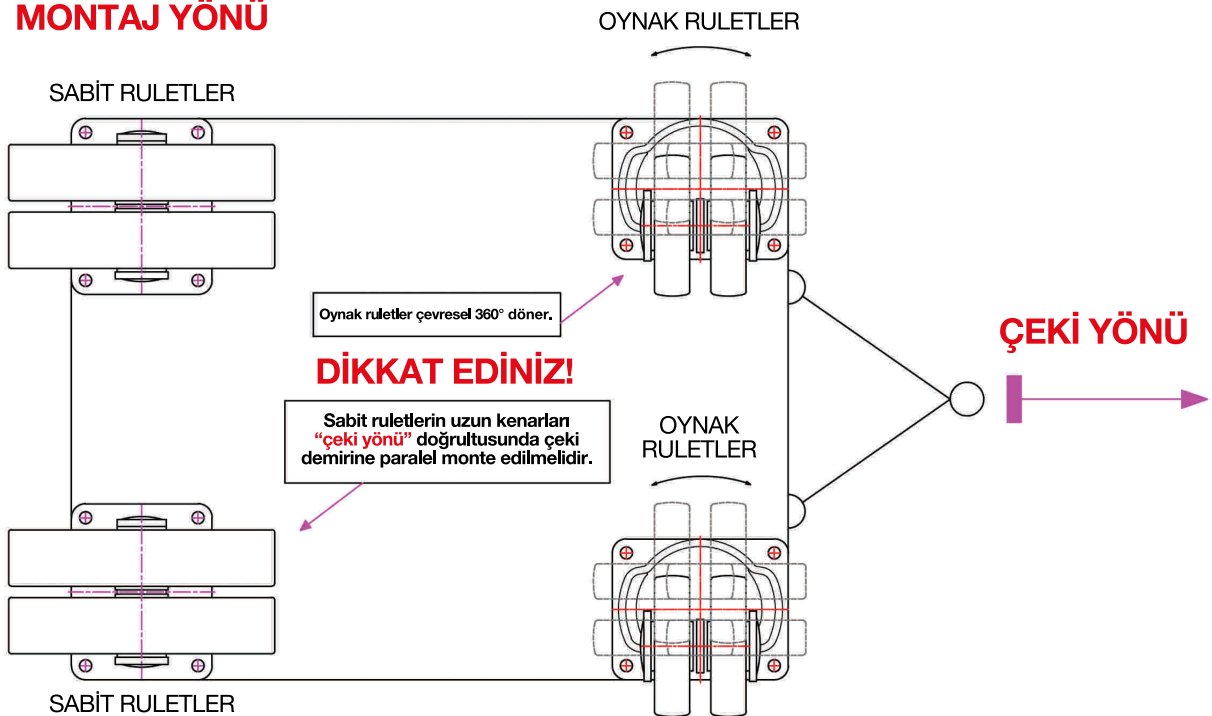



6700 Serisi



























- A: Dövme çelikten üretilen dikdörtgen dört delikli bağlantı tablası.
- B: Büte rulman.
- C: Rulet yataklama mili (Tabla civatası)
- D: Konik rulman.
- E: Üst rulman yataklama flanşı.
- F: Gresörlük.
- G: Konik rulman metal toz muhafaza kapağı.
- H: Yataklama mili taçlı emniyet somunu.
- I: Emniyet gupilyası.











MONTAJ YÖNÜ























 mm	 mm	 mm	 mm	 mm	 mm	 mm	 mm	 kg	 DOR	DÖKÜM ÜZERİ DÖKME POLİÜRETAN KAPLI RULMANLI	 kg	 D2OR	DÖKÜM ÜZERİ RADYÜSLÜ DÖKME POLİÜRETAN KAPLI RULMANLI
150	45	235	44		250x200	210x160	17	1600	6702-DOR-150	1600	6702-D2OR-150		
150	45	235	44	175	250x200	210x160	17	1600	6702-DOR-150F09	1600	6702-D2OR-150F09		
150	45	235			250x200	210x160	17	1600	6707-DOR-150	1600	6707-D2OR-150		
200	50	280	52		250x200	210x160	17	2400	6702-DOR-200	2400	6702-D2OR-200		
200	50	280	52	175	250x200	210x160	17	2400	6702-DOR-200F09	2400	6702-D2OR-200F09		
200	50	280			250x200	210x160	17	2400	6707-DOR-200	2400	6707-D2OR-200		
250	60	334	64		250x200	210x160	17	2800	6702-DOR-250	2800	6702-D2OR-250		
250	60	334	64	175	250x200	210x160	17	2800	6702-DOR-250F09	2800	6702-D2OR-250F09		
250	60	334			250x200	210x160	17	2800	6707-DOR-250	2800	6707-D2OR-250		
260	65	339	64		250x200	210x160	17	2800	6702-DOR-260	-	-		
260	65	339	64	175	250x200	210x160	17	2800	6702-DOR-260F09	-	-		
260	65	339			250x200	210x160	17	2800	6707-DOR-260	-	-		
300	70	377	71		250x200	210x160	17	3200	6702-DOR-300	3200	6702-D2OR-300		
300	70	377	71	175	250x200	210x160	17	3200	6702-DOR-300F09	3200	6702-D2OR-300F09		
300	70	377			250x200	210x160	17	3200	6707-DOR-300	3200	6707-D2OR-300		
350	80	426	81		250x200	210x160	17	3600	6702-DOR-350	-	-		
350	80	426	81	175	250x200	210x160	17	3600	6702-DOR-350F09	-	-		
350	80	426			250x200	210x160	17	3600	6707-DOR-350	-	-		

 mm	 mm	 mm	 mm	 mm	 mm	 mm	 mm	 kg	 DYR	DÖKÜM ÜZERİ KASNAK ÜZERİ VULKANİZE LASTİK KAPLI RULMANLI	 kg	 RPR	POLİAMİD TEKER RULMANLI
150	45	235	44		250x200	210x160	17	400	6702-DYR-150	1200	6702-RPR-150		
150	45	235	44	175	250x200	210x160	17	400	6702-DYR-150F09	1200	6702-RPR-150F09		
150	45	235			250x200	210x160	17	400	6707-DYR-150	1200	6707-RPR-150		
200	50	280	52		250x200	210x160	17	640	6702-DYR-200	1800	6702-RPR-200		
200	50	280	52	175	250x200	210x160	17	640	6702-DYR-200F09	1800	6702-RPR-200F09		
200	50	280			250x200	210x160	17	640	6707-DYR-200	1800	6707-RPR-200		
220	60	298	55		250x200	210x160	17	900	6702-DYR-220	-	-		
220	60	298	55	175	250x200	210x160	17	900	6702-DYR-220F09	-	-		
220	60	298			250x200	210x160	17	900	6707-DYR-220	-	-		
250	60	334	64		250x200	210x160	17	1000	6702-DYR-250	2200	6702-RPR-250		
250	60	334	64	175	250x200	210x160	17	1000	6702-DYR-250F09	2200	6702-RPR-250F09		
250	60	334			250x200	210x160	17	1000	6707-DYR-250	2200	6707-RPR-250		
270	70	362	71		250x200	210x160	17	-	-	2800	6702-RPR-270		
270	70	362	71	175	250x200	210x160	17	-	-	2800	6702-RPR-270F09		
270	70	362			250x200	210x160	17	-	-	2800	6707-RPR-270		
300	70	377	71		250x200	210x160	17	1200	6702-DYR-300	-	-		
300	70	377	71	175	250x200	210x160	17	1200	6702-DYR-300F09	-	-		
300	70	377			250x200	210x160	17	1200	6707-DYR-300	-	-		
350	80	426	81		250x200	210x160	17	1300	6702-DYR-350	-	-		
350	80	426	81	175	250x200	210x160	17	1300	6702-DYR-350F09	-	-		
350	80	426			250x200	210x160	17	1300	6707-DYR-350	-	-		
380	80	452.5	86		250x200	210x160	17	1600	6702-DYR-380	-	-		
380	80	452.5	86	175	250x200	210x160	17	1600	6702-DYR-380F09	-	-		
380	80	452.5			250x200	210x160	17	1600	6707-DYR-380	-	-		

 mm	 mm	 mm	 mm	 mm	 mm	 mm	 mm	 kg	 K2OR	KAMALON KASNAK ÜZERİ DÖKME OVAL POLİÜRETAN KAPLI RULMANLI	 kg	 KOR	KAMALON KASNAK ÜZERİ DÖKME POLİÜRETAN KAPLI RULMANLI
150	50	235	44		250x200	210x160	17	-	-	-	1400	6702-KOR-150	
150	50	235	44	175	250x200	210x160	17	-	-	-	1400	6702-KOR-150F09	
150	50	235			250x200	210x160	17	-	-	-	1400	6707-KOR-150	
200	50	280	52		250x200	210x160	17	2000	6702-K2OR-200	2000	2000	6702-KOR-200	
200	50	280	52	175	250x200	210x160	17	2000	6702-K2OR-200F09	2000	2000	6702-KOR-200F09	
200	50	280			250x200	210x160	17	2000	6707-K2OR-200	2000	2000	6707-KOR-200	
250	50	334	64		250x200	210x160	17	2400	6702-K2OR-250	2400	2400	6702-KOR-250	
250	50	334	64	175	250x200	210x160	17	2400	6702-K2OR-250F09	2400	2400	6702-KOR-250F09	
250	50	334			250x200	210x160	17	2400	6707-K2OR-250	2400	2400	6707-KOR-250	

 mm	 mm	 mm	 mm	 mm	 mm	 mm	 mm	 kg	 KUR	KAMALON ÜZERİ ENJ. POLİÜRETAN KAPLI RULMANLI
150	50	235	44		250x200	210x160	17	1400	6702-KUR-150	
150	50	235	44	175	250x200	210x160	17	1400	6702-KUR-150F09	
150	50	235			250x200	210x160	17	1400	6707-KUR-150	
200	50	280	52		250x200	210x160	17	2000	6702-KUR-200	
200	50	280	52	175	250x200	210x160	17	2000	6702-KUR-200F09	
200	50	280			250x200	210x160	17	2000	6707-KUR-200	

 mm	 mm	 mm	 mm	 mm	 mm	 mm	 mm	 kg	 DLR	DÖKÜM ÜZERİ GEÇME LASTİK RULMANLI
200	60	280	52		250x200	210x160	17	760	6702-DLR-200	
200	60	280	52	175	250x200	210x160	17	760	6702-DLR-200F09	
200	60	280			250x200	210x160	17	760	6707-DLR-200	
220	60	298	55		250x200	210x160	17	800	6702-DLR-220	
220	60	298	55	175	250x200	210x160	17	800	6702-DLR-220F09	
220	60	298			250x200	210x160	17	800	6707-DLR-220	
300	70	377	71		250x200	210x160	17	900	6702-DLR-300	
300	70	377	71	175	250x200	210x160	17	900	6702-DLR-300F09	
300	70	377			250x200	210x160	17	900	6707-DLR-300	

 mm	 mm	 mm	 mm	 mm	 mm	 mm	 mm	 kg	 DDR	DÖKÜM TEKER RULMANLI
150	45	235	44		250x200	210x160	17	1600	6702-DDR-150	
150	45	235	44	175	250x200	210x160	17	1600	6702-DDR-150F09	
150	45	235			250x200	210x160	17	1600	6707-DDR-150	
200	50	280	52		250x200	210x160	17	2000	6702-DDR-200	
200	50	280	52	175	250x200	210x160	17	2000	6702-DDR-200F09	
200	50	280			250x200	210x160	17	2000	6707-DDR-200	
250	50	334	64		250x200	210x160	17	2400	6702-DDR-250	
250	50	334	64	175	250x200	210x160	17	2400	6702-DDR-250F09	
250	50	334			250x200	210x160	17	2400	6707-DDR-250	

Serilerde Kullanılan Tabla Ölçüleri

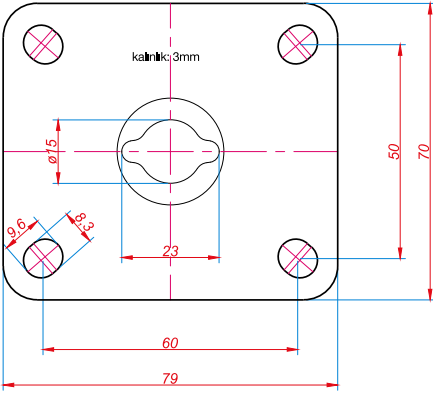

4102 / 055

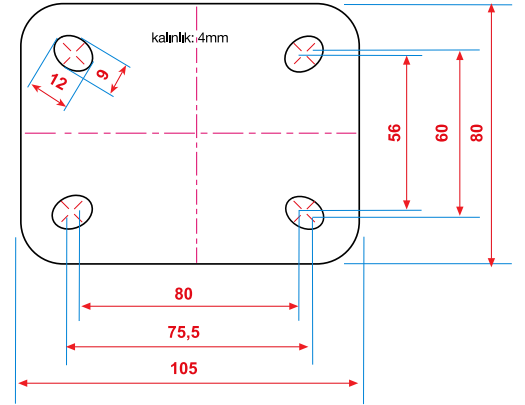

4102 / 080

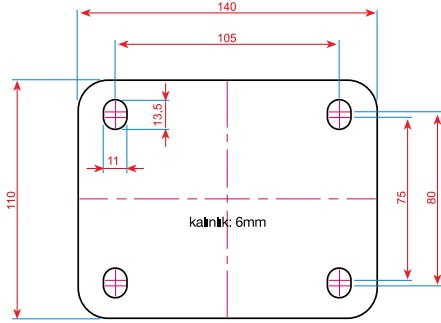

4102/100-200

4302/150-250

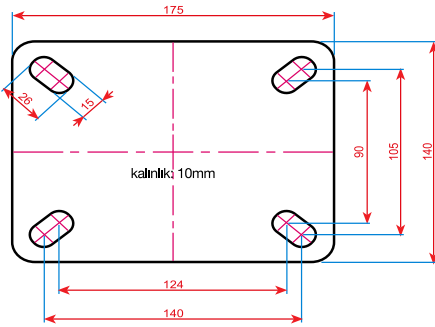

5102/150-380

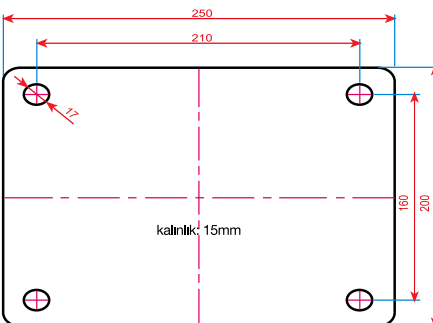

6702/150-380

www.kama.com.tr



KAMA PRES SANAYİ ve TİCARET A.Ş.

Evren Mahallesi Gülbahar Caddesi No: 92
34212 Bağcılar - İSTANBUL - TURKEY

Tel: +90.212.655 21 00 PBX • Fax: +90.212.550 35 29
www.kama.com.tr • e-mail: satis@kama.com.tr

